



European
Commission

JRC SCIENCE AND POLICY REPORTS

Best Available Techniques (BAT) Reference Document for the Production of Chlor-alkali

*Industrial Emissions Directive
2010/75/EU
(Integrated Pollution
Prevention and Control)*

Thomas Brinkmann, Germán Giner Santonja,
Frauke Schorcht, Serge Roudier,
Luis Delgado Sancho

2014

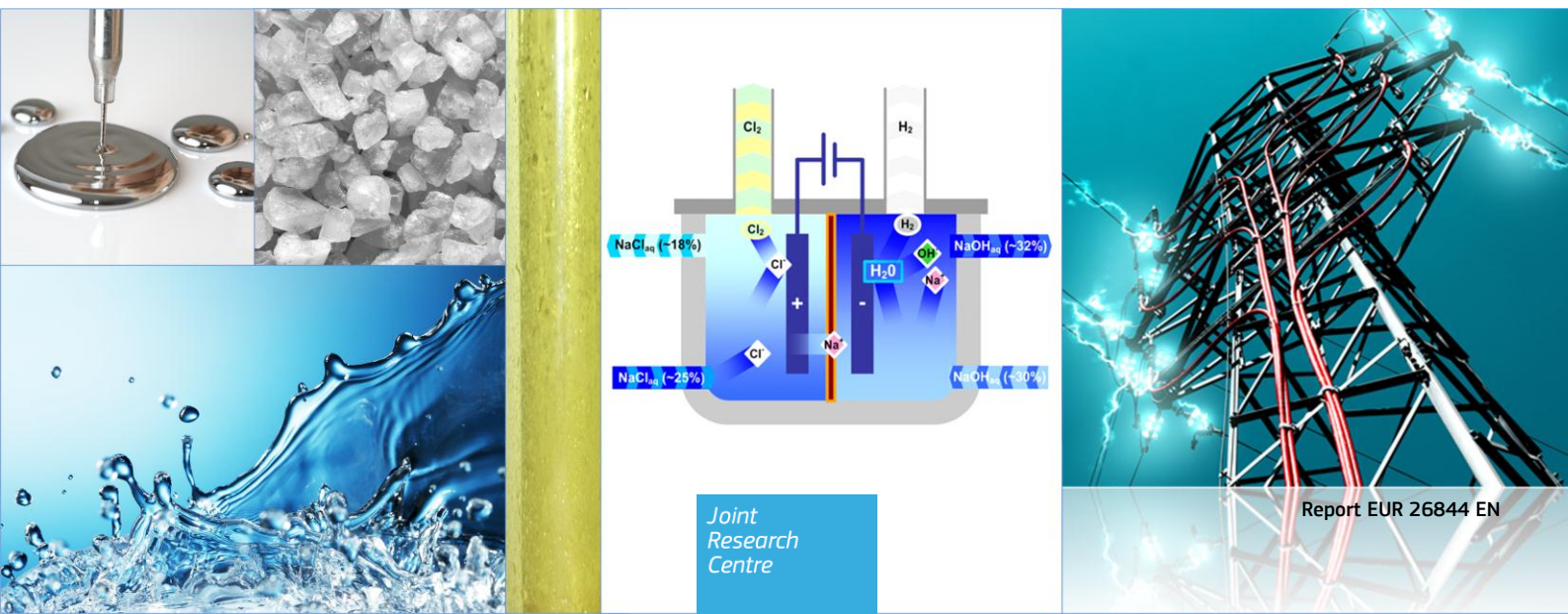

Joint
Research
Centre

Report EUR 26844 EN

European Commission
Joint Research Centre
Institute for Prospective Technological Studies

Contact information

European IPPC Bureau
Address: Joint Research Centre, Edificio Expo c/ Inca Garcilaso 3, E-41092 Seville, Spain
E-mail: JRC-IPTS-EIPPCB@ec.europa.eu
Tel.: +34 95 4488 284
Fax: +34 95 4488 426

<http://eippcb.jrc.ec.europa.eu>
<https://ec.europa.eu/jrc/en/institutes/ipts>

Legal Notice

Under the Commission Decision of 12 December 2011 on the Re-use of Commission Documents ([2011/833/EU](#)), the present BREF document is subject to free re-use, except for parts covered by any third-party rights which may be present in the document (such as images, tables, data, written material, or similar, the rights to which need to be acquired separately from their respective rights-holders for further use). The European Commission is not liable for any consequence stemming from the re-use of this publication. Any re-use is subject to the acknowledgement of the source and non-distortion of the original meaning or message

All images © European Union 2014, except: Cover pictures credits, from left to right: 1. Mercury: © fotolia.com - marcel; 2. Salt crystals: © fotolia.com - angelo.gi; 3. Water splash: © fotolia.com - Chepko Danil; 4. Chlorine: © Benjah-bmm27 – commons.wikimedia.org; 6. High voltage: © fotolia.com - carloscastilla.

JRC91156

EUR 26844 EN

ISBN 978-92-79-40945-5 (PDF)

ISSN 1831-9424 (online)

doi:10.2791/13138

Luxembourg: Publications Office of the European Union, 2014

© European Union, 2014

Reproduction is authorised provided the source is acknowledged.

Abstract

The BAT reference document entitled 'Production of Chlor-alkali' forms part of a series presenting the results of an exchange of information between EU Member States, the industries concerned, non-governmental organisations promoting environmental protection, and the Commission, to draw up, review and, where necessary, update BAT reference documents as required by Article 13(1) of the Directive 2010/75/EU on industrial emissions. This document is published by the European Commission pursuant to Article 13(6) of the Directive. This BREF for the production of chlor-alkali covers certain industrial activities specified in Sections 4.2(a) and 4.2(c) of Annex I to Directive 2010/75/EU, namely the production of chlor-alkali chemicals (chlorine, hydrogen, potassium hydroxide and sodium hydroxide) by the electrolysis of brine.

In particular, this document covers the following processes and activities:

- the storage of salt;
- the preparation, purification and resaturation of brine;
- the electrolysis of brine;
- the concentration, purification, storage and handling of sodium/potassium hydroxide;
- the cooling, drying, purification, compression, liquefaction, storage and handling of chlorine;
- the cooling, purification, compression, storage and handling of hydrogen;
- the conversion of mercury cell plants to membrane cell plants;
- the decommissioning of mercury cell plants;
- the remediation of chlor-alkali production sites.

Important issues for the implementation of Directive 2010/75/EU in the chlor-alkali industry are the conversion and decommissioning of mercury cell plants, the conversion of asbestos diaphragm cell plants and the use of non-asbestos diaphragms, electricity consumption, and emissions of chlorine to air and water. The BREF contains seven chapters. Chapters 1 and 2 provide general information on the chlor-alkali industry and on the industrial processes and techniques used within this sector. Chapter 3 provides data and information concerning the environmental performance of installations in terms of current emissions, consumption of raw materials, water and energy, and generation of waste. Chapter 4 describes the techniques to prevent or reduce the environmental impact of installations in the sector. In Chapter 5 the BAT conclusions, as defined in Article 3(12) of the Directive, are presented for the chlor-alkali industry. Chapters 6 and 7 are dedicated to emerging techniques as well as to concluding remarks and recommendations for future work in the sector, respectively.

Best Available Techniques (BAT)
Reference Document for the
Production of Chlor-alkali

Industrial Emissions Directive 2010/75/EU
Integrated Pollution Prevention and control

Authors:

Thomas Brinkmann
Germán Giner Santonja
Frauke Schorcht
Serge Roudier
Luis Delgado Sancho

2014

Acknowledgements

This report was produced by the European Integrated Pollution Prevention and Control Bureau (EIPPCB) at the European Commission's Joint Research Centre – Institute for Prospective Technological Studies (IPTS) under the supervision of Serge Roudier (Head of the EIPPCB) and Luis Delgado Sancho (Head of the Sustainable Production and Consumption Unit).

The authors of this BREF were Mr Thomas Brinkmann, Mr Germán Giner Santonja, and Ms Frauke Schorcht.

This project report was drawn up in the framework of the implementation of the Industrial Emissions Directive (2010/75/EU) and is the result of the exchange of information provided for in Article 13 of the Directive.

Major contributors of information were Euro Chlor, the European association of chlorine producers, the European Environmental Bureau (EEB) representing the environmental NGOs, and some EU Member States, mostly Austria, France, the Netherlands, Spain, and the United Kingdom, but also Belgium, the Czech Republic, Germany, Ireland, Italy, Portugal, Romania, Slovakia, and Slovenia.

The whole EIPPCB team provided contributions and peer reviewing.

This document is one from the series of foreseen documents listed below (at the time of writing, not all documents have been drafted):

Reference Document on Best Available Techniques	Code
Ceramic Manufacturing Industry	CER
Common Waste Water and Waste Gas Treatment/Management Systems in the Chemical Sector	CWW
Emissions from Storage	EFS
Energy Efficiency	ENE
Ferrous Metals Processing Industry	FMP
Food, Drink and Milk Industries	FDM
Industrial Cooling Systems	ICS
Intensive Rearing of Poultry and Pigs	IRPP
Iron and Steel Production	IS
Large Combustion Plants	LCP
Large Volume Inorganic Chemicals – Ammonia, Acids and Fertilisers	LVIC-AAF
Large Volume Inorganic Chemicals – Solids and Others Industry	LVIC-S
Large Volume Organic Chemical Industry	LVOC
Management of Tailings and Waste-rock in Mining Activities	MTWR
Manufacture of Glass	GLS
Manufacture of Organic Fine Chemicals	OFC
Non-ferrous Metals Industries	NFM
Production of Cement, Lime and Magnesium Oxide	CLM
<i>Production of Chlor-alkali</i>	CAK
Production of Polymers	POL
Production of Pulp, Paper and Board	PP
Production of Speciality Inorganic Chemicals	SIC
Refining of Mineral Oil and Gas	REF
Slaughterhouses and Animals By-products Industries	SA
Smitheries and Foundries Industry	SF
Surface Treatment of Metals and Plastics	STM
Surface Treatment Using Organic Solvents	STS
Tanning of Hides and Skins	TAN
Textiles Industry	TXT
Waste Incineration	WI
Waste Treatments Industries	WT
Wood and Wood Products Preservation with Chemicals	WPC
Wood-based Panels Production	WBP
Reference Document	
Economics and Cross-media Effects	ECM
General Principles of Monitoring	MON

Electronic versions of draft and finalised documents are publicly available and can be downloaded from <http://eippcb.jrc.ec.europa.eu>.

PREFACE

1. Status of this document

Unless otherwise stated, references to 'the Directive' in this document refer to Directive 2010/75/EU of the European Parliament and the Council on industrial emissions (integrated pollution prevention and control) (Recast).

The original best available techniques (BAT) reference document (BREF) on Production of Chlor-alkali was adopted by the European Commission in 2001. This document is the result of a review of that BREF. The review commenced in March 2009.

This BAT reference document for the Production of Chlor-alkali forms part of a series presenting the results of an exchange of information between EU Member States, the industries concerned, non-governmental organisations promoting environmental protection and the Commission, to draw up, review, and where necessary, update BAT reference documents as required by Article 13(1) of the Directive. This document is published by the European Commission pursuant to Article 13(6) of the Directive.

As set out in Article 13(5) of the Directive, the Commission Implementing Decision 2013/732/EU on the BAT conclusions contained in Chapter 5 was adopted on 9 December 2013 and published on 11 December 2013¹.

2. Participants in the information exchange

As required in Article 13(3) of the Directive, the Commission has established a forum to promote the exchange of information, which is composed of representatives from Member States, the industries concerned and non-governmental organisations promoting environmental protection (Commission Decision of 16 May 2011 establishing a forum for the exchange of information pursuant to Article 13 of the Directive 2010/75/EU on industrial emissions (2011/C 146/03), OJ C 146, 17.05.2011, p. 3).

Forum members have nominated technical experts constituting the technical working group (TWG) that was the main source of information for drafting this document. The work of the TWG was led by the European IPPC Bureau (of the Commission's Joint Research Centre).

3. Structure and contents of this document

Chapters 1 and 2 provide general information on the production of chlor-alkali and on the industrial processes and techniques used within this sector.

Chapter 3 provides data and information concerning the environmental performance of installations within the sector, and in operation at the time of writing, in terms of current emissions, consumption and nature of raw materials, water consumption, use of energy and the generation of waste.

Chapter 4 describes in more detail the techniques to prevent or, where this is not practicable, to reduce the environmental impact of installations in this sector that were considered in determining the BAT. This information includes, where relevant, the environmental performance levels (e.g. emission and consumption levels) which can be achieved by using the techniques, the associated monitoring and the costs and the cross-media issues associated with the techniques.

¹ OJ L 332, 11.12.2013, p. 34.

Chapter 5 presents the BAT conclusions as defined in Article 3(12) of the Directive.

Chapter 6 presents information on 'emerging techniques' as defined in Article 3(14) of the Directive.

Concluding remarks and recommendations for future work are presented in Chapter 7.

4. Information sources and the derivation of BAT

This document is based on information collected from a number of sources, in particular through the TWG that was established specifically for the exchange of information under Article 13 of the Directive. The information has been collated and assessed by the European IPPC Bureau (of the Commission's Joint Research Centre) who led the work on determining BAT, guided by the principles of technical expertise, transparency and neutrality. The work of the TWG and all other contributors is gratefully acknowledged.

The BAT conclusions have been established through an iterative process involving the following steps:

- identification of the key environmental issues for the sector;
- examination of the techniques most relevant to address these key issues;
- identification of the best environmental performance levels, on the basis of the available data in the European Union and worldwide;
- examination of the conditions under which these environmental performance levels were achieved, such as costs, cross-media effects, and the main driving forces involved in the implementation of the techniques;
- selection of the best available techniques (BAT), their associated emission levels (and other environmental performance levels) and the associated monitoring for this sector according to Article 3(10) of, and Annex III to, the Directive.

Expert judgement by the European IPPC Bureau and the TWG has played a key role in each of these steps and the way in which the information is presented here.

Where available, economic data have been given together with the descriptions of the techniques presented in Chapter 4. These data give a rough indication of the magnitude of the costs and benefits. However, the actual costs and benefits of applying a technique may depend strongly on the specific situation of the installation concerned, which cannot be evaluated fully in this document. In the absence of data concerning costs, conclusions on the economic viability of techniques are drawn from observations on existing installations.

5. Review of BAT reference documents (BREFs)

BAT is a dynamic concept and so the review of BREFs is a continuing process. For example, new measures and techniques may emerge, science and technologies are continuously developing and new or emerging processes are being successfully introduced into the industries. In order to reflect such changes and their consequences for BAT, this document will be periodically reviewed and, if necessary, updated accordingly.

6. Contact information

All comments and suggestions should be made to the European IPPC Bureau at the Institute for Prospective Technological Studies at the following address:

European Commission
JRC Institute for Prospective Technological Studies
European IPPC Bureau
Edificio Expo
c/ Inca Garcilaso, 3
E-41092 Seville, Spain
Telephone: +34 954 488 284
Fax: +34 954 488 426
E-mail: JRC-IPTS-EIPPCB@ec.europa.eu
Internet: <http://eippcb.jrc.ec.europa.eu>

Best Available Techniques Reference Document for the Production of Chlor-alkali

PREFACE	I
SCOPE	XVII
1 GENERAL INFORMATION	1
1.1 INDUSTRIAL AND ECONOMIC DEVELOPMENT OF THE CHLOR-ALKALI SECTOR	1
1.2 INDUSTRY SIZE AND GEOGRAPHIC DISTRIBUTION OF CHLOR-ALKALI PRODUCTION SITES IN THE EU-27 AND EFTA COUNTRIES	3
1.3 TECHNIQUES IN USE	5
1.4 CHLOR-ALKALI PRODUCTS AND THEIR USE	7
1.4.1 Consumption of chlorine	7
1.4.2 Consumption of sodium hydroxide	8
1.4.3 Chlorine/sodium hydroxide: a delicate balance	8
1.4.4 Consumption of potassium hydroxide	9
1.4.5 Consumption of hydrogen	10
1.5 ENVIRONMENTAL RELEVANCE OF THE CHLOR-ALKALI INDUSTRY	11
2 APPLIED PROCESSES AND TECHNIQUES	13
2.1 OVERVIEW	13
2.2 THE MERCURY CELL TECHNIQUE	18
2.2.1 General description	18
2.2.2 The cell and the decomposer	19
2.3 THE DIAPHRAGM CELL TECHNIQUE	21
2.3.1 General description	21
2.3.2 The cell	22
2.4 THE MEMBRANE CELL TECHNIQUE	25
2.4.1 General description	25
2.4.2 The cell	26
2.4.3 Monopolar and bipolar electrolysers	29
2.5 BRINE SUPPLY	32
2.5.1 Sources, qualities and storage of salt	32
2.5.2 Brine preparation	33
2.5.3 Brine purification	33
2.5.3.1 General description	33
2.5.3.2 Primary purification	33
2.5.3.3 Secondary purification: membrane cell technique	34
2.5.3.4 Control of nitrogen compounds in the brine	38
2.5.4 Brine dechlorination and resaturation	38
2.5.5 Chlorate destruction: membrane cell technique	39
2.6 CHLORINE PROCESSING, STORAGE AND HANDLING	40
2.6.1 General description	40
2.6.2 Materials	40

2.6.3	Cooling	40
2.6.4	Cleaning of wet chlorine.....	41
2.6.5	Drying	41
2.6.6	Cleaning of dry chlorine	41
2.6.7	Compression	42
2.6.8	Liquefaction.....	42
2.6.9	Handling and storage	43
2.6.10	Vaporisation.....	44
2.6.11	Dealing with impurities	44
2.6.11.1	Overview	44
2.6.11.2	Water	44
2.6.11.3	Hydrogen	44
2.6.11.4	Nitrogen trichloride	45
2.6.11.5	Bromine	45
2.6.12	The chlorine absorption unit	45
2.6.12.1	Purpose	45
2.6.12.2	Chemical reactions.....	47
2.6.12.3	Use and treatment of the produced bleach	48
2.7	CAUSTIC PROCESSING, STORAGE AND HANDLING.....	49
2.8	HYDROGEN PROCESSING, STORAGE AND HANDLING	51
2.9	PRODUCTION OF CAUSTIC POTASH	52
3	CURRENT EMISSION AND CONSUMPTION LEVELS.....	55
3.1	INTRODUCTION.....	55
3.2	OVERVIEW OF EMISSION AND CONSUMPTION LEVELS OF ALL CELL PLANTS	57
3.3	CONSUMPTION LEVELS OF ALL CELL PLANTS	59
3.3.1	Sodium chloride/potassium chloride.....	59
3.3.2	Water.....	60
3.3.3	Ancillary materials.....	62
3.3.4	Energy.....	64
3.3.4.1	Overview	64
3.3.4.2	Energy consumption for preparation and purification of raw materials	65
3.3.4.3	Energy consumption for the electrolysis.....	65
3.3.4.3.1	General considerations.....	65
3.3.4.3.2	Energy consumption of mercury cells	67
3.3.4.3.3	Energy consumption of diaphragm cells.....	68
3.3.4.3.4	Energy consumption of membrane cells	68
3.3.4.3.5	Comparison of electrolysis cells	69
3.3.4.3.6	Production of caustic potash	70
3.3.4.4	Energy consumption for caustic soda concentration.....	70
3.3.4.5	Energy consumption for auxiliary equipment.....	71
3.3.4.6	Comparison of the three cell techniques	72
3.4	EMISSIONS AND WASTE GENERATION FROM ALL CELL PLANTS	74
3.4.1	Overview.....	74
3.4.2	Emissions from the storage and handling of solids	75
3.4.3	Emissions and waste generation from the brine circuit	75
3.4.3.1	Overview	75

3.4.3.2	Emissions to air	75
3.4.3.3	Emissions to water	76
3.4.3.3.1	Overview	76
3.4.3.3.2	Sulphate.....	76
3.4.3.3.3	Chloride.....	77
3.4.3.3.4	Free chlorine.....	78
3.4.3.3.5	Chlorate and bromate	80
3.4.3.3.6	Heavy metals except mercury	81
3.4.3.3.7	Organic compounds.....	82
3.4.3.3.8	Halogenated organic compounds	83
3.4.3.3.9	Sulphite	84
3.4.3.4	Generation of wastes	84
3.4.4	Emissions and waste generation from chlorine processing, storage and handling.....	86
3.4.4.1	Overview	86
3.4.4.2	Emissions to air	86
3.4.4.2.1	Carbon dioxide	86
3.4.4.2.2	Chlorine.....	86
3.4.4.2.3	Chlorine dioxide.....	87
3.4.4.2.4	Carbon tetrachloride	88
3.4.4.2.5	Refrigerants	88
3.4.4.3	Emissions to water	89
3.4.4.4	Generation of wastes	89
3.4.4.4.1	Spent sulphuric acid from chlorine drying	89
3.4.4.4.2	Carbon tetrachloride	89
3.4.4.4.3	Bleach.....	89
3.4.5	Emissions and waste generation from sodium and potassium hydroxide processing.....	90
3.4.6	Emissions from hydrogen processing.....	90
3.4.7	Emissions during other than normal operating conditions	91
3.4.7.1	Emissions during start-up and shutdown operations	91
3.4.7.2	Emissions during incidents and accidents	91
3.4.7.3	Emissions during decommissioning	91
3.4.8	Emissions of noise.....	92
3.5	EMISSION AND CONSUMPTION LEVELS AND WASTE GENERATION FROM MERCURY CELL PLANTS.....	93
3.5.1	Overview	93
3.5.2	Mercury in cells.....	93
3.5.3	Reporting of figures per chlorine capacity	96
3.5.4	Consumption of mercury.....	96
3.5.5	Overall mercury emissions and waste generation	96
3.5.6	Emissions to air	102
3.5.6.1	Overview	102
3.5.6.2	Cell room ventilation.....	103
3.5.6.2.1	Emission levels.....	103
3.5.6.2.2	Influencing factors.....	104
3.5.6.3	Process exhaust	105
3.5.6.3.1	Overview	105
3.5.6.3.2	Vents from the brine system.....	106
3.5.6.3.3	Vents from caustic processing.....	107
3.5.6.3.4	Burnt or emitted hydrogen	107

3.5.6.3.5	Vents from storage.....	107
3.5.6.3.6	Exhausts and vents from the recovery retort.....	108
3.5.6.3.7	Vents from workshops	108
3.5.7	Emissions to water.....	108
3.5.7.1	Overview	108
3.5.7.2	Emission levels	109
3.5.7.2.1	Mercury.....	109
3.5.7.2.2	Sulphides.....	109
3.5.8	Emissions via products	110
3.5.9	Generation of wastes.....	110
3.5.9.1	Overview	110
3.5.9.2	Solids from brine purification.....	111
3.5.9.3	Solids from caustic filtration.....	112
3.5.9.4	Solids from waste water treatment.....	112
3.5.9.5	Activated carbon from treatment of gaseous streams	112
3.5.9.6	Graphite from decomposer packing.....	112
3.5.9.7	Residues from retorts	113
3.5.9.8	Wastes from maintenance and renewal.....	113
3.5.9.9	Waste generation levels	113
3.5.10	Mass balance calculation	115
3.5.11	Emissions and waste generation during other than normal operating conditions.....	116
3.5.11.1	Emissions during start-up and shutdown operations.....	116
3.5.11.2	Emissions during incidents and accidents.....	116
3.5.11.3	Emissions and waste generation during decommissioning.....	117
3.6	EMISSION AND CONSUMPTION LEVELS AND WASTE GENERATION FROM DIAPHRAGM CELL PLANTS.....	119
3.6.1	Overview.....	119
3.6.2	Consumption levels.....	119
3.6.3	Emissions to air.....	119
3.6.4	Emissions to water	120
3.6.5	Generation of wastes.....	120
3.7	EMISSION AND CONSUMPTION LEVELS AND WASTE GENERATION FROM MEMBRANE CELL PLANTS.....	122
3.7.1	Consumption and emission levels.....	122
3.7.2	Generation of wastes.....	122
3.8	HISTORICAL CONTAMINATION OF CHLOR-ALKALI SITES	123
3.8.1	Overview.....	123
3.8.2	Mercury.....	123
3.8.3	PCDDs/PCDFs, PCBs, PCNs and PAHs.....	126
4	TECHNIQUES TO CONSIDER IN THE DETERMINATION OF BEST AVAILABLE TECHNIQUES	129
4.1	MERCURY CELL PLANTS.....	130
4.1.1	Techniques to reduce emissions of mercury and to reduce the generation of waste contaminated with mercury	130
4.1.2	Conversion of mercury cell plants to membrane cell plants.....	130
4.1.3	Decommissioning	142

4.1.3.1	Decommissioning plan	142
4.1.3.2	Wastes consisting of elemental mercury or wastes contaminated with mercury..	152
4.2	DIAPHRAGM CELL PLANTS	153
4.2.1	Techniques to reduce emissions of asbestos and to reduce the generation of asbestos-containing waste	153
4.2.2	Asbestos-free diaphragms	153
4.2.3	Conversion of asbestos diaphragm cell plants to membrane cell plants	158
4.3	DIAPHRAGM AND MEMBRANE CELL PLANTS	161
4.3.1	Environmental management systems	161
4.3.2	Techniques to reduce the consumption of raw materials	161
4.3.2.1	Salt	161
4.3.2.1.1	Choice of salt type	161
4.3.2.1.2	Techniques to reduce the consumption of salt	162
4.3.2.1.3	Recycling of waste water from other production processes	162
4.3.2.2	Water	164
4.3.2.2.1	Overview	164
4.3.2.2.2	Brine recirculation	164
4.3.2.2.3	Recycling of other process streams	165
4.3.2.2.4	Concentration of brine filtration sludges	166
4.3.2.2.5	Use of waste water for solution mining	167
4.3.2.2.6	Use of waste water in other production units	168
4.3.2.2.7	Miscellaneous techniques	168
4.3.2.2.8	Combination of techniques to reduce the generation of waste water	168
4.3.2.3	Energy	170
4.3.2.3.1	High-performance bipolar membrane cells	170
4.3.2.3.2	High-performance membranes	176
4.3.2.3.3	High-performance electrodes and coatings	178
4.3.2.3.4	High-purity brine	179
4.3.2.3.5	Iron(III) <i>meso</i> -tartrate as an anti-caking agent	180
4.3.2.3.6	Once-through brine system	182
4.3.2.3.7	Use of hydrogen as a chemical reagent or as a fuel for combustion	185
4.3.3	Techniques for monitoring of emissions	187
4.3.3.1	Overview	187
4.3.3.2	Common issues of all monitoring techniques	187
4.3.3.3	Monitoring techniques and frequencies	187
4.3.3.4	Monitoring of chlorine and chlorine dioxide in air	189
4.3.3.5	Monitoring of free chlorine in water	191
4.3.3.6	Monitoring of halogenated organic compounds in water	192
4.3.4	Techniques to prevent or to limit the environmental consequences of accidents and incidents	193
4.3.5	Techniques to reduce emissions to air	200
4.3.5.1	The chlorine absorption unit	200
4.3.5.2	Scrubbing with hydrogen peroxide to reduce emissions of chlorine dioxide	206
4.3.5.3	Carbon tetrachloride-free chlorine purification and recovery	208
4.3.5.4	Use of refrigerants without ozone depletion potential and with low global warming potential	210
4.3.6	Techniques to reduce emissions to water	213
4.3.6.1	Techniques to reduce emissions of sulphate	213
4.3.6.1.1	Overview	213
4.3.6.1.2	Crystallisation of sodium sulphate	213
4.3.6.2	Techniques to reduce emissions of chloride	214

4.3.6.2.1	Overview.....	214
4.3.6.2.2	Nanofiltration.....	214
4.3.6.3	Techniques to reduce emissions of free chlorine	217
4.3.6.3.1	Overview.....	217
4.3.6.3.2	Common issues for all techniques to reduce emissions of free chlorine	218
4.3.6.3.3	Chemical reduction	218
4.3.6.3.4	Catalytic decomposition.....	220
4.3.6.3.5	Thermal decomposition	223
4.3.6.3.6	Acidic decomposition	224
4.3.6.3.7	Use of waste water streams containing free chlorine in other production units	225
4.3.6.4	Techniques to reduce emissions of chlorate	226
4.3.6.4.1	Overview.....	226
4.3.6.4.2	Brine acidification.....	226
4.3.6.4.3	Acidic reduction.....	229
4.3.6.4.4	Catalytic reduction.....	232
4.3.6.4.5	Use of waste water streams containing chlorate in other production units	233
4.3.6.5	Techniques to reduce emissions of halogenated organic compounds.....	234
4.3.7	Techniques to reduce the generation of sulphuric acid waste.....	235
4.3.7.1	Use on site or off site	235
4.3.7.2	Reconcentration of spent sulphuric acid	236
4.3.8	Techniques to reduce emissions of noise.....	238
4.4	TECHNIQUES FOR THE REMEDIATION OF CONTAMINATED SITES	239
4.4.1	Overview.....	239
4.4.2	Site remediation plan	239
4.4.3	Containment.....	241
4.4.4	Decontamination.....	243
4.4.4.1	Overview	243
4.4.4.2	Thermal desorption.....	244
4.4.4.3	Soil washing	246
5	BEST AVAILABLE TECHNIQUES (BAT) CONCLUSIONS.....	249
	SCOPE	249
	GENERAL CONSIDERATIONS.....	250
	DEFINITIONS.....	251
	BAT CONCLUSIONS.....	252
5.1	CELL TECHNIQUE	252
5.2	DECOMMISSIONING OR CONVERSION OF MERCURY CELL PLANTS.....	253
5.3	GENERATION OF WASTE WATER.....	255
5.4	ENERGY EFFICIENCY	256
5.5	MONITORING OF EMISSIONS.....	257
5.6	EMISSIONS TO AIR	258
5.7	EMISSIONS TO WATER	260
5.8	GENERATION OF WASTE	262
5.9	SITE REMEDIATION	263
	GLOSSARY.....	264

6	EMERGING TECHNIQUES	265
6.1	OVERVIEW	265
6.2	OXYGEN-DEPOLARISED CATHODES	266
6.3	FOUR-STAGE CAUSTIC EVAPORATOR IN MEMBRANE CELL PLANTS.....	270
7	CONCLUDING REMARKS AND RECOMMENDATIONS FOR FUTURE WORK.....	273
8	ANNEXES.....	275
8.1	INSTALLED CHLORINE PRODUCTION CAPACITIES	275
8.2	TECHNIQUES TO REDUCE MERCURY EMISSIONS AND TO REDUCE THE GENERATION OF WASTE CONTAMINATED WITH MERCURY	278
8.2.1	Overview	278
8.2.2	Summary of techniques to reduce mercury emissions and to reduce the generation of wastes contaminated with mercury	278
8.2.3	Reduction of mercury emissions to air, including hydrogen.....	284
8.2.3.1	Removal of mercury from process exhausts	284
8.2.3.2	Removal of mercury from hydrogen	285
8.2.4	Reduction of mercury emissions to water	286
8.2.5	Removal of mercury from caustic soda.....	286
8.2.6	Treatment of wastes contaminated with mercury.....	287
8.3	TECHNIQUES TO REDUCE EMISSIONS OF ASBESTOS AND TO REDUCE THE GENERATION OF ASBESTOS-CONTAINING WASTE	290
	GLOSSARY.....	295
	I. ISO COUNTRY CODES	295
	II. MONETARY UNITS	296
	III. SYMBOLS COMMONLY USED IN THIS DOCUMENT	296
	IV. UNIT PREFIXES.....	297
	V. UNITS	297
	VI. CHEMICAL ELEMENTS	298
	VII. CHEMICAL FORMULAE COMMONLY USED IN THIS DOCUMENT	299
	VIII. ACRONYMS AND DEFINITIONS	300
	REFERENCES.....	303

List of Figures

Figure 1.1:	Share per region of world chlorine production capacities in 2012	1
Figure 1.2:	Development of chlorine production and utilisation ratio of plant capacity in the EU and EFTA countries	2
Figure 1.3:	Chlor-alkali production sites in the EU-27 and EFTA countries as of January 2013.....	3
Figure 1.4:	Annual chlorine production capacities in the EU-27 and EFTA countries as of January 2013.....	4
Figure 1.5:	Share of cell techniques to chlorine production capacity in the EU-27 and EFTA countries	6
Figure 1.6:	Chlorine applications in the EU-27 and EFTA countries in 2012.....	7
Figure 1.7:	Caustic soda applications in the EU-27 and EFTA countries in 2012.....	8
Figure 1.8:	Caustic potash applications in the EU-27 and EFTA countries in 2009	9
Figure 2.1:	Typical flow diagram of the three cell techniques	14
Figure 2.2:	Schematic view of chlorine electrolysis cells.....	15
Figure 2.3:	Schematic view of a mercury electrolysis cell with horizontal and vertical decomposers ...	18
Figure 2.4:	View of a mercury cell room.....	20
Figure 2.5:	Flow diagram of the integration of the membrane or mercury and the diaphragm cell techniques.....	21
Figure 2.6:	Schematic view of a typical monopolar diaphragm cell.....	23
Figure 2.7:	View of an open-air diaphragm cell room equipped with monopolar electrolysers	23
Figure 2.8:	Flow diagram of the integration of the membrane and mercury cell techniques.....	26
Figure 2.9:	Schematic view of a typical bipolar membrane electrolysis cell.....	27
Figure 2.10:	View of a membrane cell room equipped with bipolar electrolysers	27
Figure 2.11:	View of a membrane cell room equipped with monopolar electrolysers	28
Figure 2.12:	Schematic view of a membrane.....	29
Figure 2.13:	Simplified scheme of monopolar and bipolar electrolysers	30
Figure 2.14:	Electrolyser architecture.....	30
Figure 2.15:	Flow diagram of a possible layout for the brine system used in the membrane cell technique	34
Figure 2.16:	View of polishing filters in a secondary brine purification system	35
Figure 2.17:	View of chelate resin towers in a secondary brine purification system.....	36
Figure 2.18:	View of a chlorine absorption unit	46
Figure 2.19:	View of caustic production and storage	49
Figure 3.1:	Cell voltage and specific electrical energy consumption versus cell current density for the mercury cell technique	66
Figure 3.2:	Specific electrical energy consumption versus cell current density for the different chlor-alkali electrolysis techniques	69
Figure 3.3:	Major potential sources of emissions and waste in a membrane cell plant	74
Figure 3.4:	Trend of mercury emissions from mercury cell plants in Western Europe (OSPAR countries) from 1977 to 1998	100
Figure 3.5:	Trend of mercury emissions from mercury cell plants in the EU-27 and EFTA countries from 1995 to 2013.....	101
Figure 3.6:	Major solid waste sources in mercury cell plants.....	111
Figure 3.7:	Trend of the average difference to balance for chlor-alkali plants in OSPAR countries from 1977 to 2008.....	115
Figure 4.1:	Main changes for the conversion of a mercury cell plant to a membrane cell plant	130
Figure 4.2:	View of the deposition of an asbestos-free diaphragm on a cathode.....	154
Figure 4.3:	Impact of technological development of the bipolar membrane cell technique on specific electricity consumption and maximum current densities	171
Figure 4.4:	Choice of current density based on capital costs and electricity prices	174
Figure 4.5:	Flow diagram of brine recirculation and once-through brine processes.....	183
Figure 4.6:	Flow diagram of a possible layout of a chlorine absorption unit with two absorption columns	201
Figure 4.7:	Flow diagram of a possible layout of a chlorine absorption unit with an ejector system connected to an absorption column	202

Figure 4.8:	Flow diagram of a catalytic decomposition fixed-bed reactor process installed on the blowdown stream of a chlorine absorption unit.....	221
Figure 4.9:	Effect of pH value on the location of iron hydroxide precipitation in membranes	228
Figure 4.10:	Flow diagram of acidic chlorate reduction	229
Figure 4.11:	Flow diagram of the on-site thermal desorption system used at a chlor-alkali site in Taipei (Taiwan)	245
Figure 4.12:	Flow diagram of a soil washing system.....	247
Figure 6.1:	Schematic view of a three-compartment, finite-gap membrane cell with an oxygen-depolarised cathode (Bayer/Uhde design)	267
Figure 8.1:	Example of handling of asbestos at the Dow plant in Stade (Germany).....	291

List of Tables

Table 2.1:	Main typical characteristics of the different electrolysis techniques	17
Table 2.2:	Typical configurations of a monopolar and a bipolar membrane cell plant	31
Table 2.3:	Typical compositions of sodium chloride used in chlor-alkali electrolysis.....	32
Table 2.4:	Typical impurities with sources and effects on the membrane cell technique, as well as typical brine specifications	37
Table 2.5:	Trade-offs in chlorine gas liquefaction.....	43
Table 2.6:	Typical compositions of potassium chloride used in chlor-alkali electrolysis	52
Table 2.7:	Caustic potash specifications from different suppliers	53
Table 3.1:	Example table explaining how emission and consumption data are typically displayed in the tables of this chapter.....	56
Table 3.2:	Overview of the main emission and consumption levels in chlor-alkali plants in the EU-27 and EFTA countries in 2008 to 2011 using a brine recirculation system	58
Table 3.3:	Salt consumption in chlor-alkali plants with brine recirculation in the EU-27 and EFTA countries in 2008 to 2011	59
Table 3.4:	Consumption of water as solvent for caustic production.....	60
Table 3.5:	Waste water generation in chlor-alkali plants in the EU-27 and EFTA countries in 2008 to 2011.....	61
Table 3.6:	Use of main chemical auxiliaries in chlor-alkali plants using a brine recirculation process.....	62
Table 3.7:	Consumption of main chemical auxiliaries in chlor-alkali plants in the EU-27 and EFTA countries in 2008 to 2011	63
Table 3.8:	Consumption of carbon tetrachloride by chlor-alkali plants in the EU-27	63
Table 3.9:	Operating conditions and electricity consumption of the chlor-alkali electrolysis cells in the EU-27 and EFTA countries	67
Table 3.10:	Operating conditions and electricity consumption of monopolar and bipolar chlor-alkali membrane electrolysis cells in the EU-27 and EFTA countries	69
Table 3.11:	Caustic concentration at the cell outlet and steam consumption for caustic concentration in chlor-alkali plants in the EU-27 and EFTA countries	70
Table 3.12:	Energy consumption for auxiliary processes of chlor-alkali plants in the EU-27 and EFTA countries	71
Table 3.13:	Total energy consumption of chlor-alkali plants in the EU-27 and EFTA countries	72
Table 3.14:	Emissions of sulphate to water from chlor-alkali plants in the EU-27 and EFTA countries in 2008 to 2011	77
Table 3.15:	Emissions of chloride to water from chlor-alkali plants in the EU-27 and EFTA countries in 2008 to 2011	78
Table 3.16:	Emissions of free chlorine to water from chlor-alkali plants in the EU-27 and EFTA countries in 2008 to 2011	79
Table 3.17:	Emissions of chlorate to water from chlor-alkali plants in the EU-27 and EFTA countries in 2008 to 2011	80
Table 3.18:	Emissions of bromate to water from chlor-alkali plants in the EU-27 and EFTA countries in 2008 to 2011	81
Table 3.19:	Emissions of heavy metals to water from chlor-alkali plants in the EU-27 and EFTA countries in 2008 to 2011	82
Table 3.20:	Emissions of organic compounds to water from chlor-alkali plants in the EU-27 and EFTA countries in 2008 to 2011	83
Table 3.21:	Emissions of halogenated organic compounds to water from chlor-alkali plants in the EU-27 and EFTA countries in 2008 to 2011	84
Table 3.22:	Generation of sludges from primary brine purification in chlor-alkali plants in the EU-27 and EFTA countries in 2008 to 2011	85
Table 3.23:	Emissions of chlorine to air from chlor-alkali plants in the EU-27 and EFTA countries in 2008–2011.....	87
Table 3.24:	Emissions of carbon tetrachloride by chlor-alkali plants in the EU-27 in 2006 to 2011	88
Table 3.25:	Emissions of refrigerants by chlor-alkali plants in the EU-27 in 2008 to 2011	88
Table 3.26:	Generation of sulphuric acid waste in chlor-alkali plants in the EU-27 and EFTA countries in 2008 to 2011	89

Table 3.27:	Share of hydrogen emitted by chlor-alkali plants in the EU-27 and EFTA countries in 2010	90
Table 3.28:	Emissions of noise from chlor-alkali plants in the EU-27 and EFTA countries in 2008 to 2011	92
Table 3.29:	Amounts of metallic mercury on sites of mercury cell plants in the EU-27 and EFTA countries in December 2012	94
Table 3.30:	Mercury emissions from individual mercury cell plants in 2013.....	98
Table 3.31:	Mercury emission data from the EMECAP project and Euro Chlor for three mercury cell plants in 2002/2003	102
Table 3.32:	Emissions of mercury to air from the cell room from mercury cell plants in the EU-27 and EFTA countries in 2008/2009.....	103
Table 3.33:	Fugitive mercury emissions from the cell room from three mercury cell plants in the United States in 2005/2006.....	104
Table 3.34:	Mercury emissions to air from process exhausts from chlor-alkali plants in OSPAR countries in 2009	106
Table 3.35:	Emissions of mercury to water from mercury cell plants in the EU-27 and EFTA countries in 2008 to 2011	109
Table 3.36:	Mercury concentrations in sludges from primary brine purification of mercury cell plants in the EU-27 and EFTA countries in 2008 to 2011	112
Table 3.37:	Waste generation and treatment at the AkzoNobel chlor-alkali plant in Bohus (Sweden) in 1998/1999.....	114
Table 3.38:	Waste generation and treatment at the Hydro Polymers AB chlor-alkali plant in Stenungsund (Sweden)	114
Table 3.39:	Mercury collected, recovered, or disposed of with waste during decommissioning of mercury cell plants.....	118
Table 3.40:	Concentrations of asbestos in air in asbestos diaphragm cell plants in the EU-27	120
Table 3.41:	Generation of sludges from secondary brine purification in membrane cell plants in the EU-27 in 2009 to 2011	122
Table 3.42:	Estimation of total number of mercury-contaminated chlor-alkali sites in the EU-27 and EFTA countries and contamination levels.....	124
Table 3.43:	Examples of mercury-contaminated chlor-alkali sites in the EU-27 and EFTA countries	125
Table 3.44:	Examples of chlor-alkali sites contaminated with PCDDs/PCDFs, PCBs, PCNs and PAHs.....	127
Table 4.1:	Information for each technique described in this chapter	129
Table 4.2:	Data from the conversion of the Borregaard mercury cell plant in Sarpsborg (Norway) to the membrane cell technique	134
Table 4.3:	Electricity savings due to conversion to the membrane cell technique in different chlor-alkali plants worldwide.....	135
Table 4.4:	Investment costs for the cell room conversion of a mercury cell plant with a final chlorine capacity of 100 kt/yr	137
Table 4.5:	Investment costs for the conversion of a mercury cell plant with a chlorine capacity of 100 kt/yr and a design current density of 5 kA/m ²	138
Table 4.6:	Comparison of reported conversion costs of mercury cell plants	139
Table 4.7:	Estimation of economic benefits resulting from the conversion of a mercury cell plant with a chlorine capacity of 100 kt/yr	141
Table 4.8:	Overview of contaminated solid materials arising during decommissioning and possible decontamination techniques.....	145
Table 4.9:	Techniques for monitoring of mercury in air, water and waste	147
Table 4.10:	Example data from mercury cell plants with low mercury emissions to water in the EU-27 in 2008 - 2011.....	149
Table 4.11:	Mercury concentrations in waste water of membrane cell plants that were converted from mercury cell plants	150
Table 4.12:	Decommissioning costs at the Borregaard mercury cell plant in Sarpsborg (Norway) in 1997	150
Table 4.13:	Decommissioning costs at the Ercros mercury cell plant in Sabiñánigo (Spain) in 2009..	151
Table 4.14:	Example data from diaphragm and membrane cell plants with low generation of waste water in the EU-27 in 2009 to 2011	169

Table 4.15:	Number of cells and electrolyzers as a function of current density for a bipolar membrane cell plant with a chlorine capacity of 100 kt/yr	171
Table 4.16:	Electricity consumption of bipolar membrane cell electrolyzers using the latest technique as a function of current density	172
Table 4.17:	Expected electricity consumption of new bipolar membrane cell electrolyzers under optimum start-up conditions.....	172
Table 4.18:	Typical production costs for a membrane cell plant with a chlorine production capacity of 500 kt/yr.....	173
Table 4.19:	Cost calculation of simple payback times for the replacement of an electrolysis unit	175
Table 4.20:	Energy consumption for brine reconcentration in membrane cell plants using solution-mined brine.....	184
Table 4.21:	Monitoring techniques and frequencies for pollutants relevant to diaphragm and membrane cell plants.....	188
Table 4.22:	Concentrations of halogenated organic compounds in waste water from a membrane cell plant using three different monitoring methods	192
Table 4.23:	List of some preventative and corrective or emergency techniques associated with the storage of liquid chlorine.....	196
Table 4.24:	List of some preventative and corrective or emergency techniques at loading areas of a chlor-alkali plant	198
Table 4.25:	Example data from plants with low chlorine emissions from the chlorine absorption unit in the EU-27 in 2007 to 2011	204
Table 4.26:	Advantages and disadvantages of refrigerants frequently used in chlor-alkali plants for chlorine liquefaction.....	211
Table 4.27:	Examples of operational cost savings for plants replacing brine purge or barium sulphate precipitation by nanofiltration.....	216
Table 4.28:	Example data from chlor-alkali plants with low emissions of free chlorine to water in the EU-27 in 2008 to 2011	219
Table 4.29:	Typical operating costs for partial hypochlorite destruction using catalytic fixed-bed decomposition or chemical reduction.....	222
Table 4.30:	Example data from membrane cell plants using brine acidification with low emissions of chlorate to water in the EU-27 in 2009 to 2011	227
Table 4.31:	Example data from membrane cell plants using acidic reduction with low emissions of chlorate to water in the EU-27 in 2008 to 2011	230
Table 4.32:	Typical operational data from an on-site sulphuric acid reconcentration system.....	237
Table 4.33:	Potential techniques for the decontamination of mercury-contaminated soils	243
Table 7.1:	Key milestones of the review process of the BREF for the Production of Chlor-Alkali....	273
Table 8.1:	Installed chlorine production capacities in the EU-27 and EFTA countries as of 1 January 2013	275
Table 8.2:	Overview of applied techniques and mercury emission levels at the INEOS ChlorVinyls plant in Stenungsund (Sweden) from 2005 to 2011	281
Table 8.3:	Overview of applied techniques and mercury emission levels at the Solvin plant in Antwerp-Lillo (Belgium) from 2005 to 2011.....	282
Table 8.4:	Mercury emission levels to air and water and mercury losses with products that can be achieved at best	283
Table 8.5:	Overview of techniques for the treatment of wastes contaminated with mercury with typical performance levels	288

SCOPE

This BREF for the production of chlor-alkali covers certain industrial activities specified in Sections 4.2(a) and 4.2(c) of Annex I to Directive 2010/75/EU, namely the production of chlor-alkali chemicals (chlorine, hydrogen, potassium hydroxide and sodium hydroxide) by the electrolysis of brine.

In particular, this document covers the following processes and activities:

- the storage of salt;
- the preparation, purification and resaturation of brine;
- the electrolysis of brine;
- the concentration, purification, storage and handling of sodium/potassium hydroxide;
- the cooling, drying, purification, compression, liquefaction, storage and handling of chlorine;
- the cooling, purification, compression, storage and handling of hydrogen;
- the conversion of mercury cell plants to membrane cell plants;
- the decommissioning of mercury cell plants;
- the remediation of chlor-alkali production sites.

This BREF document does not address the following activities or processes:

- the electrolysis of hydrochloric acid for the production of chlorine;
- the electrolysis of brine for the production of sodium chlorate; this is covered by the BAT reference document on Large Volume Inorganic Chemicals – Solids and Others Industry (LVIC-S);
- the electrolysis of molten salts for the production of alkali or alkaline earth metals and chlorine; this is covered by the BAT reference document on Non-ferrous Metals Industries (NFM);
- the production of specialities such as alcoholates, dithionites and alkali metals by using alkali metal amalgam produced with the mercury cell technique;
- the production of chlorine, hydrogen or sodium/potassium hydroxide by processes other than electrolysis.

This BREF document does not address the following aspects of chlor-alkali production as they are covered by the BAT reference document on Common Waste Water and Waste Gas Treatment/Management Systems in the Chemical Sector (CWW):

- the treatment of waste water in a downstream treatment plant;
- environmental management systems;
- noise emissions.

Scope

Other reference documents which are of relevance for the activities covered in this document are the following:

Reference document	Subject
Common Waste Water and Waste Gas Treatment/Management Systems in the Chemical Sector BREF (CWW)	Common waste water and waste gas treatment/management systems
Economics and Cross-Media Effects (ECM)	Economics and cross-media effects of techniques
Emissions from Storage (EFS)	Storage and handling of materials
Energy Efficiency (ENE)	General aspects of energy efficiency
Industrial Cooling Systems (ICS)	Indirect cooling with water
Large Combustion Plants (LCP)	Combustion plants with a rated thermal input of 50 MW or more
General Principles of Monitoring (MON)	General aspects of emissions and consumption monitoring
Waste Incineration (WI)	Waste incineration
Waste Treatments Industries (WT)	Waste treatment

The scope of the BREF does **not** include matters that only concern safety in the workplace or the safety of products because these matters are not covered by the Directive. They are discussed only where they affect matters within the scope of the Directive. Therefore, the document also covers techniques to prevent or to limit the **environmental consequences** of accidents and incidents.

1 GENERAL INFORMATION

1.1 Industrial and economic development of the chlor-alkali sector

The chlor-alkali industry sector produces chlorine, sodium/potassium hydroxide (also called caustic soda/potash) and hydrogen by the electrolysis of brine.

In 2012, the global chlorine production capacity was estimated to be 76.8 Mt. Figure 1.1 shows the share of installed production capacities per region in 2012. On a global scale, 2007 was a record growth year for the chlor-alkali industry which then experienced a dramatic contraction in 2008 and 2009 due to the economic crisis. In 2010, the global industry was again on a growth path. Relatively little new capacity is however expected in the United States, Europe and Japan. More growth is anticipated in the less developed regions of the world. China will continue to be the driver of global chlor-alkali capacity expansion [4, WCC 2012], [5, CMAI 2010].

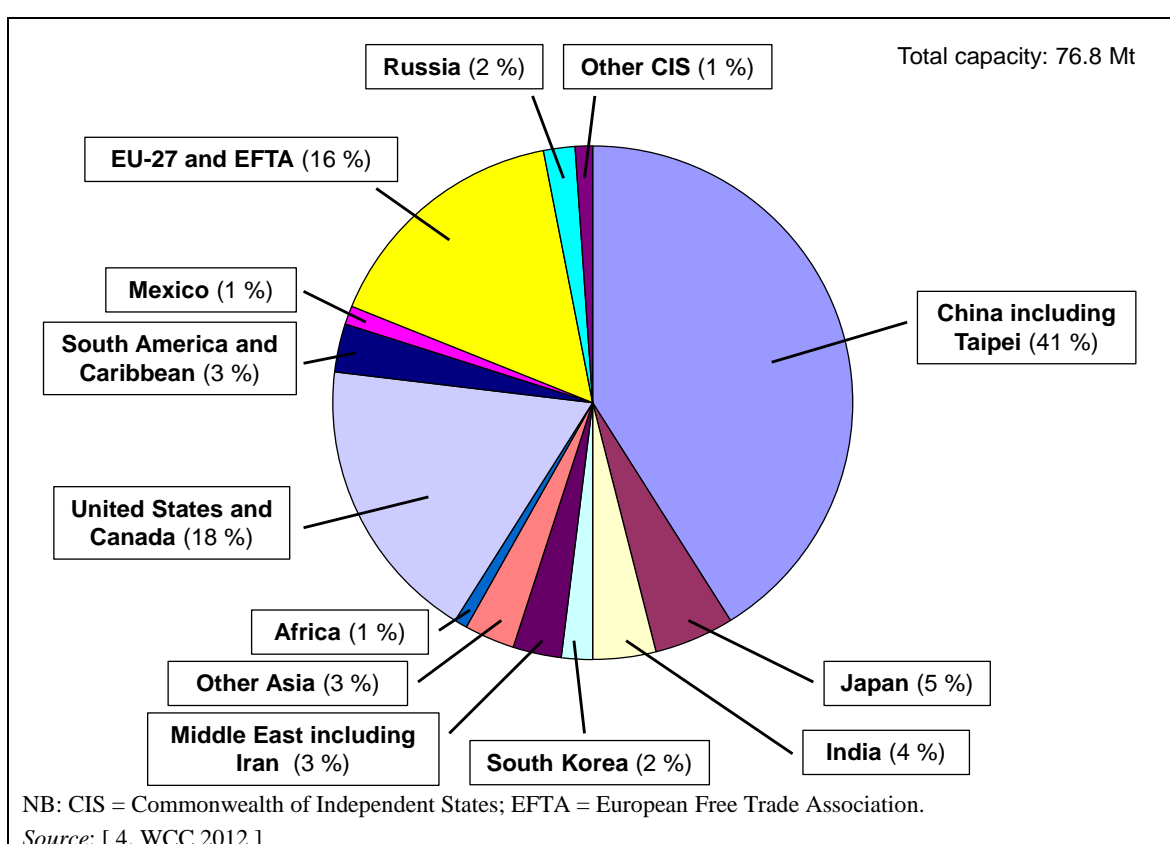

Figure 1.1: Share per region of world chlorine production capacities in 2012

Figure 1.2 gives an overview of how chlorine production and the utilisation ratio of plant capacity have developed since 1960 in Europe. In the EU-15 and EFTA countries, production steadily increased from approximately 2 Mt in 1960 to approximately 9 Mt in the mid-1990s. During the first decade of the 21st century, production in the EU-27 and EFTA countries oscillated between 9.6 and 10.8 Mt with a sharp drop to 9.1 Mt in 2009 due to the worldwide economic crisis. Following the same pattern, the utilisation ratio of plant capacity oscillated between 80 % and 90 % and declined sharply to 71 % in 2009. From 2010 onwards, chlorine production and utilisation ratio were higher than in 2009, but still lower than the pre-crisis levels [2, Le Chlore 2002], [6, Euro Chlor 2011], [9, Euro Chlor 2013].

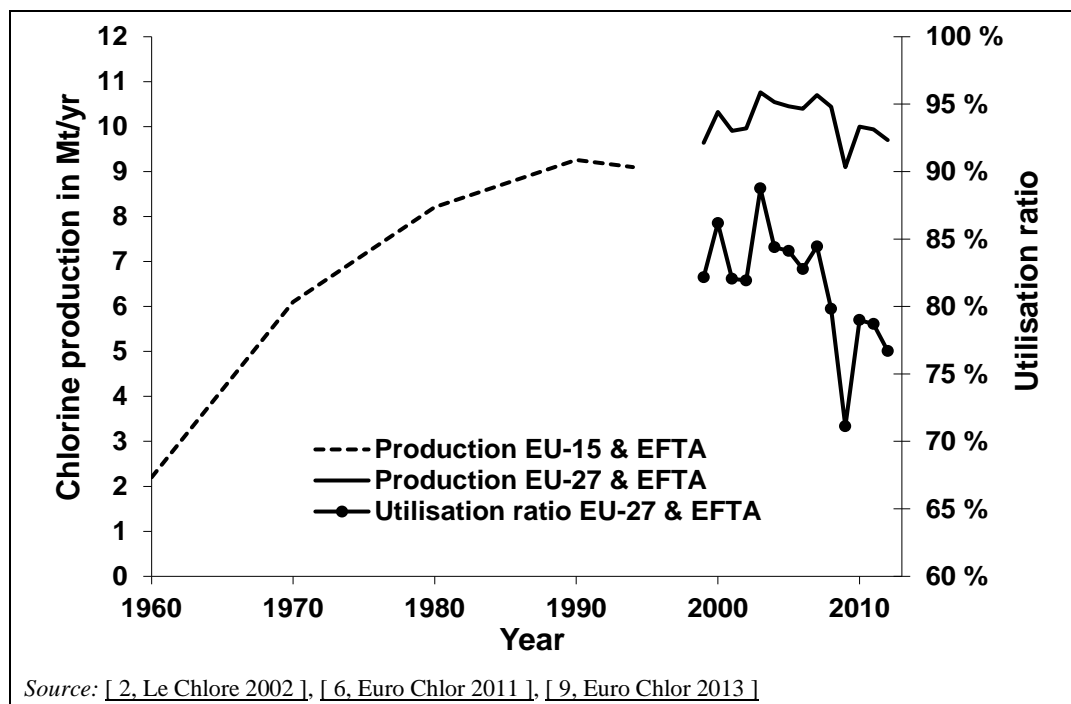

Figure 1.2: Development of chlorine production and utilisation ratio of plant capacity in the EU and EFTA countries

The chlor-alkali industry is the basis for approximately 55 % of the chemical industry in the EU-27 and EFTA countries and it generated a turnover of almost EUR 770 billion in 2008. The chlor-alkali industry directly employs about 39 000 people, while approximately 2 000 000 jobs are estimated to be directly or indirectly related to the use of chlorine and caustic soda when the numerous downstream activities are taken into consideration [7, Euro Chlor 2010], [8, Euro Chlor 2011].

1.2 Industry size and geographic distribution of chlor-alkali production sites in the EU-27 and EFTA countries

In 2012, chlorine with its co-products sodium/potassium hydroxide and hydrogen was produced at 75 chlor-alkali plants in 21 of the EU-27 and EFTA countries (Figure 1.3), with a total chlorine capacity of 12.2 Mt/yr. 66 plants produced exclusively sodium hydroxide, five plants exclusively potassium hydroxide and four plants both. Approximately 3–4 % of the chlorine production capacity is coupled with the production of potassium hydroxide and approximately 96–97 % with the production of sodium hydroxide. A detailed list of the plants is given in Table 8.1 in the Annex [3, Euro Chlor 2011], [9, Euro Chlor 2013].

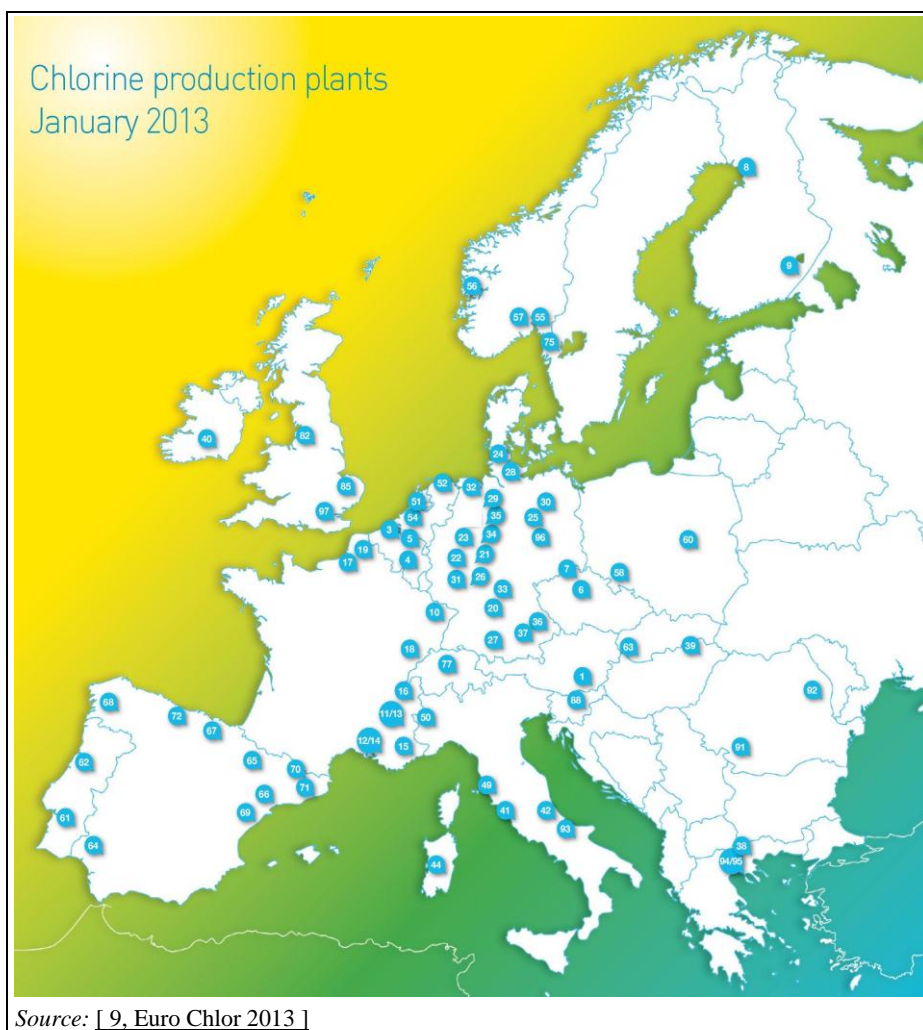

Figure 1.3: Chlor-alkali production sites in the EU-27 and EFTA countries as of January 2013

The chlor-alkali sector in Europe has developed over time and is scattered geographically. Many relatively small plants are still operating; however, there have been shutdowns in the last few years because of stagnating markets and concerns over the impending phase-out of mercury cell production [60, SRI Consulting 2008]. Since chlorine and caustic are co-products that are produced in almost equal amounts, the distribution of the caustic manufacturing industry is essentially the same as that of the chlorine manufacturing industry.

Figure 1.4 shows the annual chlorine production capacities in the EU-27 and EFTA countries as of January 2013. Germany is the country with by far the largest chlorine production capacity, accounting for approximately 41 % of European production capacity, followed by France, Belgium, the Netherlands, Spain and the United Kingdom.

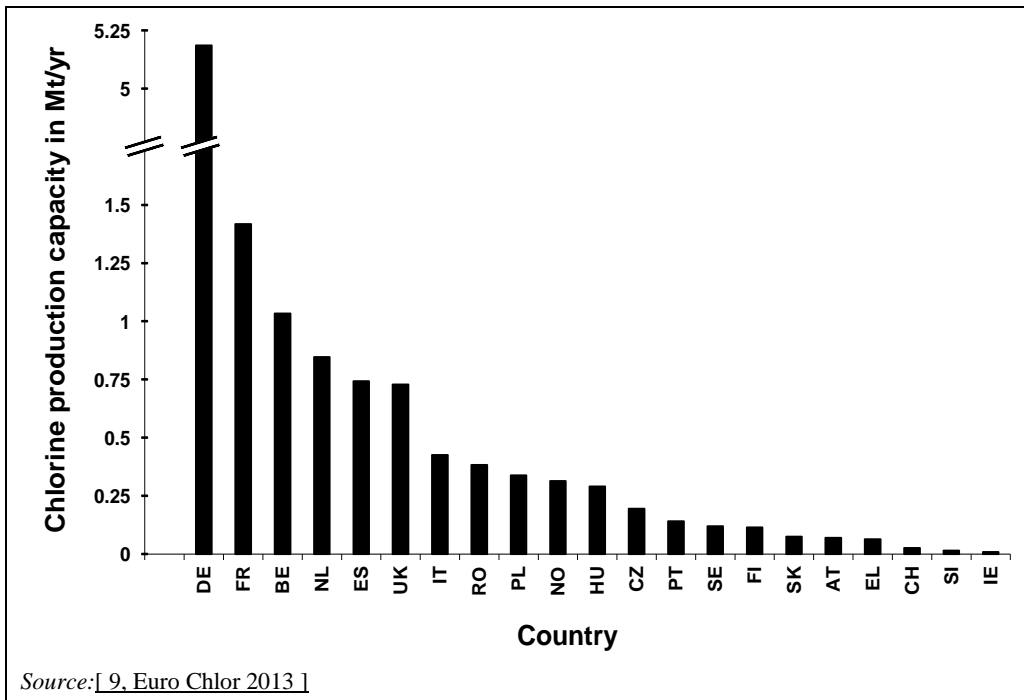

Figure 1.4: Annual chlorine production capacities in the EU-27 and EFTA countries as of January 2013

1.3 Techniques in use

The main techniques applied for chlor-alkali production are mercury, diaphragm and membrane cell electrolysis, usually using sodium chloride as feed or to a lesser extent using potassium chloride for the production of potassium hydroxide. Other electrochemical processes in which chlorine is produced include the electrolysis of hydrochloric acid and the electrolysis of molten alkali metal and alkaline earth metal chlorides, in which chlorine is a co-product. In 2012, these accounted for approximately 3 % of the total chlorine production capacity in the EU-27 and EFTA countries. Additionally, two plants in Germany produce alcoholates and thiosulphates together with chlorine via the mercury cell technique [9, Euro Chlor 2013].

Apart from electrochemical processes, chlorine may also be produced via chemical routes such as the catalytic oxidation of hydrochloric acid with oxygen (the Deacon process). On account of the corrosive nature of the chemicals involved and the elevated temperature and pressure, expensive materials must be used. A commercial plant is reported to have been producing 60 kt of chlorine per year in Japan since 1990 [1, Ullmann's 2006] while BASF in Antwerp brought a new plant into operation in 2011 which uses a ruthenium catalyst.

For caustic soda production, an alternative route to the electrolysis of sodium chloride is the lime-soda process. As of 2011, this process is generally not considered a profitable operation in Europe compared to the electrolysis of sodium chloride. One plant in Romania is reported to use the lime-soda process [223, ICIS Chemical Business 2010]. The situation seems to be different in the United States, where mineral deposits of natural sodium carbonate exist. In 2000, this process accounted for 1–2 % of the total world capacity of caustic soda [10, Kirk-Othmer 2002].

Up to the end of the 20th century, the mercury cell technique dominated in Europe, while the diaphragm cell technique dominated in the United States and the membrane cell technique in Japan. This pattern has, however, changed during the first decade of the 21st century. Since 1984, no new plants based on the mercury cell technique have been built, and only a few diaphragm cell plants have been built. All new plants, including those erected in India and China, are based on the membrane cell technique, which is a state-of-the-art technique, both in economic and ecological terms [1, Ullmann's 2006].

During the period from 1997 to 2012, the share of the mercury and diaphragm cell techniques decreased significantly in the EU-27 and EFTA countries, from 63 % to 26 % and from 24 % to 14 %, respectively, while the share of the membrane cell technique more than quintupled from 11 % to 59 % (Figure 1.5). Reasons for the change include the need to replace installations which have reached the end of their service life and environmental concerns over mercury emissions from mercury cell plants.

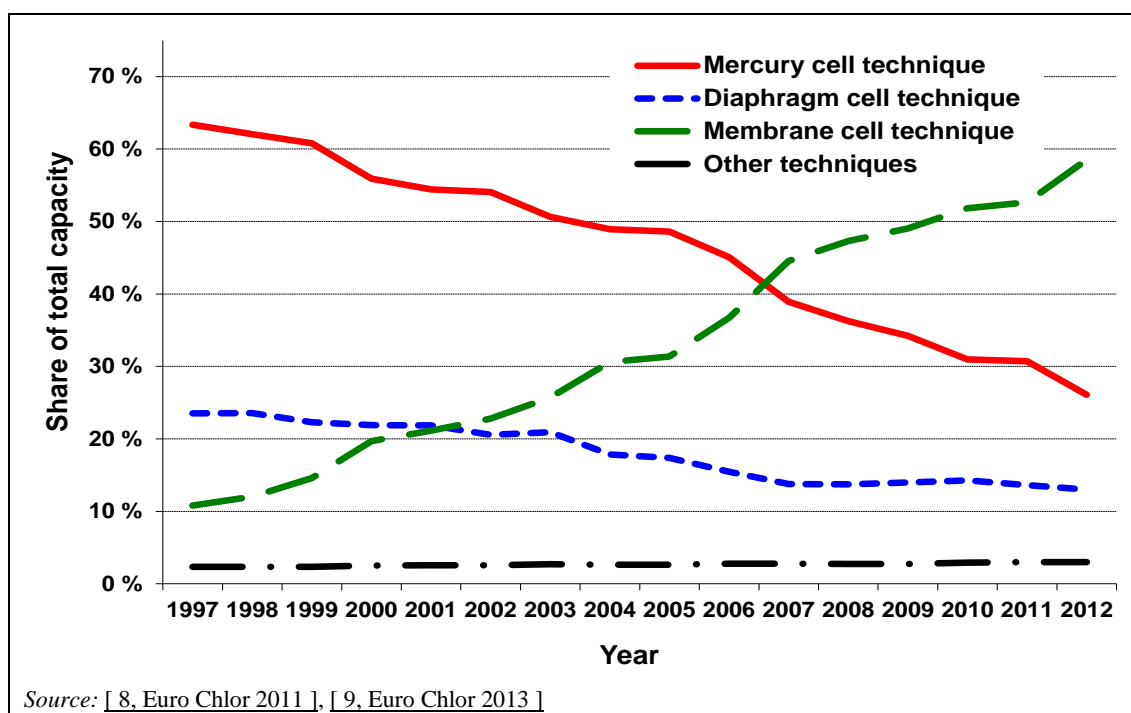

Figure 1.5: Share of cell techniques to chlorine production capacity in the EU-27 and EFTA countries

Despite the downward trend in using the mercury cell technique for the production of chlorine and caustic soda, most of the production of caustic potash in the EU-27 in 2012 was still based on it. There were only two small installations with capacities ≤ 40 kt/yr which used the membrane cell technique to produce caustic potash while there were larger installations operating outside Europe [9, Euro Chlor 2013], [42, Euro Chlor 2010].

In 2012, the global chlorine production capacity of mercury cell plants was estimated to be approximately 5.0 Mt/yr [11, UNEP 2012], equivalent to 6–7 % of the total chlorine capacity.

The global chlorine production capacity of diaphragm cell plants was approximately 20 Mt/yr in 2010, corresponding to 26 % of the total world chlorine capacity. Approximately 13 % of the global diaphragm cell plants' capacity was based on non-asbestos diaphragms while this share was approximately 30 % in the EU-27 [215, German Ministry 2011].

1.4 Chlor-alkali products and their use

1.4.1 Consumption of chlorine

Chlorine is largely used in the synthesis of chlorinated organic compounds. PVC and isocyanates are the main drivers of chlor-alkali production in the EU-27 and EFTA countries.

Chlorine is difficult to store and transport economically and, therefore, chlorine is generally produced near consumers. When other solutions cannot be found, chlorine is transported by pipe (typically over distances ≤ 10 km), road and rail.

Figure 1.6 shows the applications of chlorine in the EU-27 and EFTA countries in 2012.

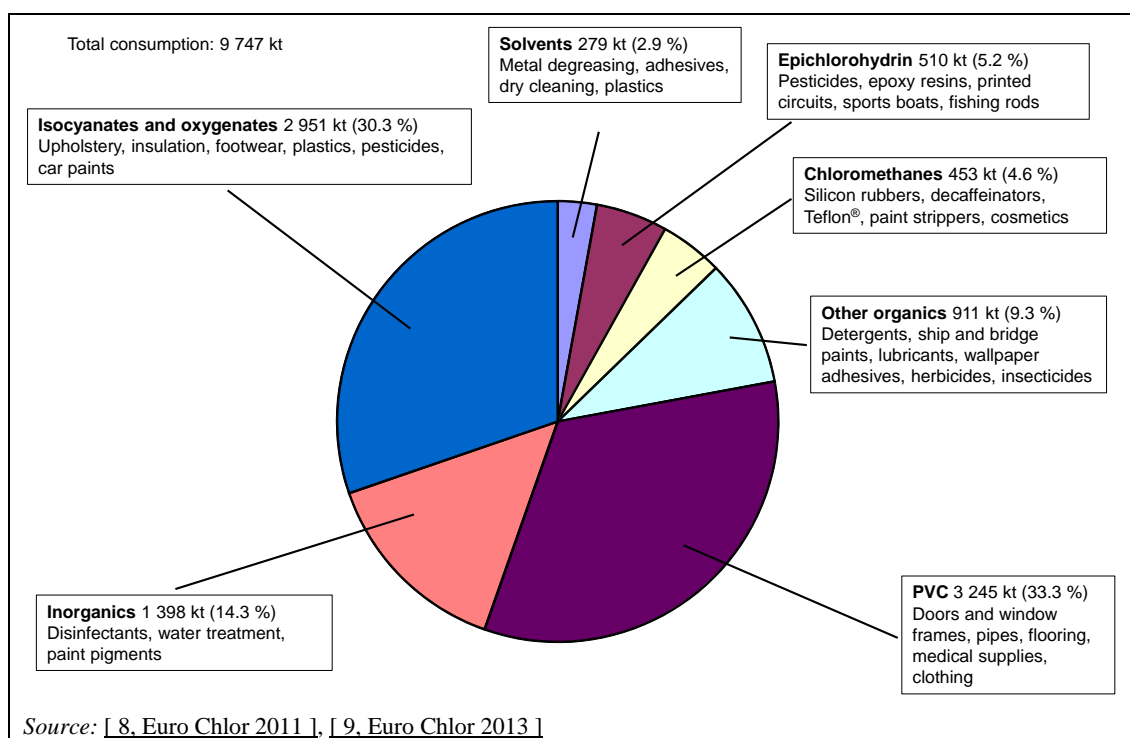

Figure 1.6: Chlorine applications in the EU-27 and EFTA countries in 2012

In 2010, imports of chlorine to the EU-27 and EFTA countries accounted for 8.9 kt while exports accounted for 32 kt; both were negligible in comparison to an overall production of 9 999 kt at that time [6, Euro Chlor 2011]. In 2012, approximately 570 kt of chlorine were transported via rail and road, which means that approximately 94 % were used on the same or adjacent sites for other chemical processes [9, Euro Chlor 2013]. The production of chlorine and caustic is completely interrelated with the downstream businesses, including the PVC industry and the intermediates used to manufacture PVC.

1.4.2 Consumption of sodium hydroxide

The output of sodium hydroxide (also called caustic soda) is proportional to that of chlorine. The ratio is more or less equal to the ratio of the molecular weights ($40.00 / 35.45 = 1.128$) but is influenced by the side reactions taking place at the electrodes and, in the case of the diaphragm and membrane cell technique, the diffusion of hydroxide through the separator. In practice, the ratio ranges from 1.070 to 1.128 [3, Euro Chlor 2011].

Due to customers' requirements, sodium hydroxide is produced commercially in two forms: as a 50 wt-% solution (most common) and less frequently in the solid state as prills, flakes or cast shapes. There are also applications where sodium hydroxide in lower concentrations is supplied and/or directly used. Figure 1.7 shows the applications of caustic soda in the EU-27 and EFTA countries in 2012.

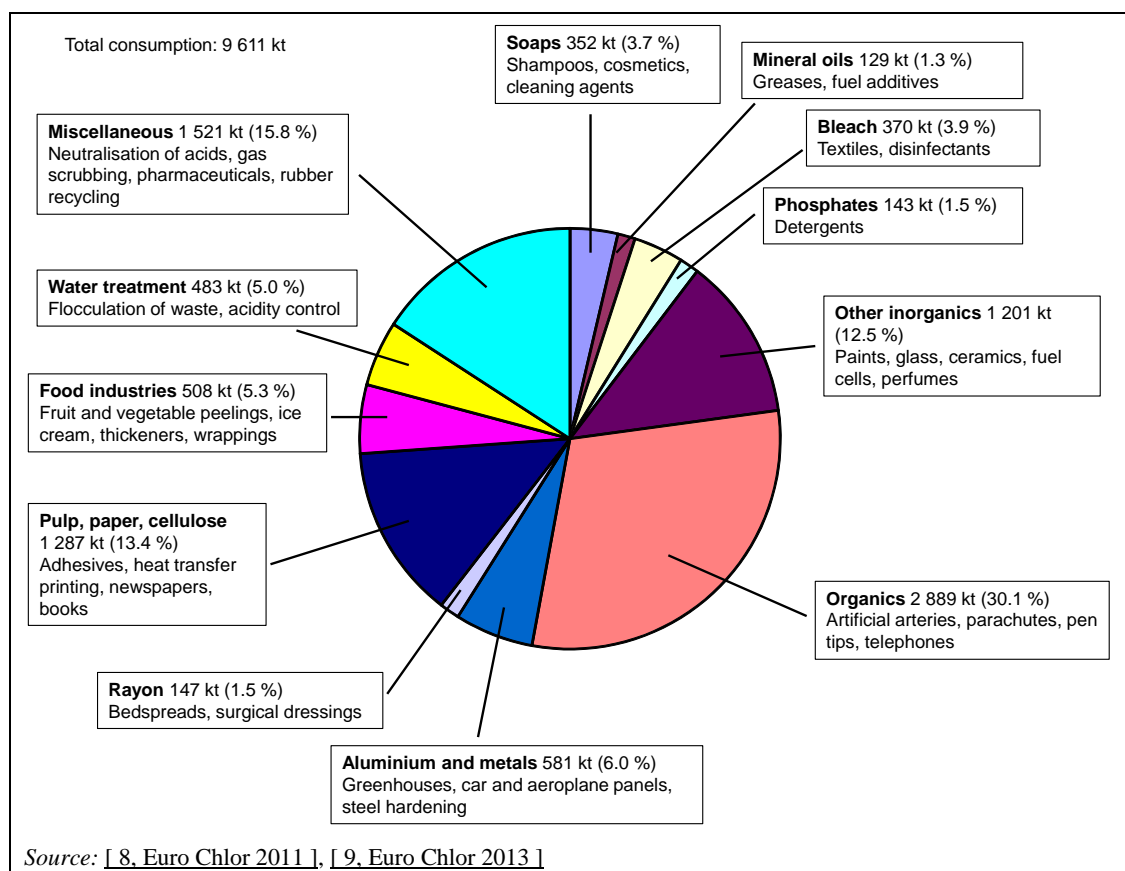

Figure 1.7: Caustic soda applications in the EU-27 and EFTA countries in 2012

Until recently, the EU-27 and EFTA countries were net exporters of sodium hydroxide. In 2010, for example, imports of liquid and solid sodium hydroxide accounted for 601 kt and 46 kt, respectively, while exports accounted for 785 kt and 90 kt, respectively [6, Euro Chlor 2011]. However, in 2013, the EU-28 became for the first time a net importer when imports of liquid sodium hydroxide accounted for 803 kt, while exports accounted for 632 kt [345, Platts 2014].

1.4.3 Chlorine/sodium hydroxide: a delicate balance

The co-production of chlorine and sodium hydroxide in fixed proportions has always been a problem for the chlor-alkali industry. Each product is manufactured for a very different end use with differing market dynamics, and it is rare that demand for the two coincides. Depending on which demand is dominant, either can be regarded as the main product, and the price varies

accordingly. Price fluctuations can be extreme between cases of excess and short supply. For example, mid-2008 saw a high of almost USD 1 000 per tonne of NaOH which fell to a low of approximately USD 15 per tonne in the fourth quarter of 2009 [48, ICIS Chemical Business 2011].

Chlorine itself is difficult to transport over long distances; however it is transported and traded over long distances as chlorinated derivatives, particularly as EDC, VCM and PVC, accounting for 85 %, and chlorinated solvents. Caustic soda is a globally traded commodity [1, Ullmann's 2006].

1.4.4 Consumption of potassium hydroxide

The output of potassium hydroxide (also called caustic potash) is proportional to that of chlorine. As for the production of sodium hydroxide, the ratio is more or less equal to the ratio of the molecular weights (in this case $56.11 / 35.45 = 1.583$) but is influenced by the side reactions taking place at the electrodes and, in the case of the diaphragm and membrane cell techniques, the diffusion of hydroxide through the separator.

Potassium hydroxide is produced commercially in two forms: as a 45–50 wt-% solution (most common) and in the solid state. Pure quality potassium hydroxide is used as a raw material for the chemical and pharmaceutical industry; in dye synthesis; for photography as a developer alkali; and as an electrolyte in batteries, fuel cells and in the electrolysis of water. Technical quality KOH is used as a raw material in the detergent and soap industry; as a starting material for inorganic potassium compounds, such as potassium phosphate and potassium carbonate; as a starting material for organic potassium compounds, such as potassium formate, acetate, benzoate, citrate, lactate and sorbate, and for the manufacture of cosmetics, glass, and textiles [12, Ullmann's 2000], [93, Euro Chlor 2011]. Figure 1.8 shows the applications of caustic potash in Europe in 2009.

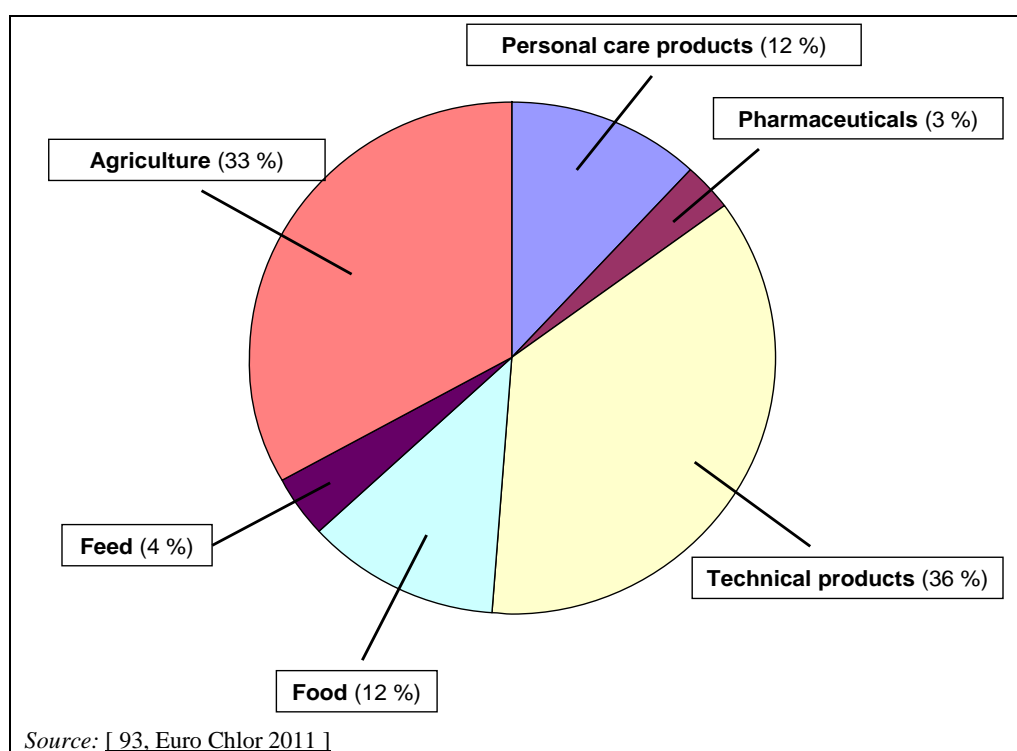

Figure 1.8: Caustic potash applications in the EU-27 and EFTA countries in 2009

1.4.5 Consumption of hydrogen

Hydrogen is also a co-product of the electrolysis of brine (approximately 28 kg per tonne of chlorine). This high quality hydrogen (purity > 99.9 %) is usually used on site, on an adjacent site, or is sold to a distributor [30, Euro Chlor 2010].

The main uses of the co-produced hydrogen are in combustion to produce steam (and some electricity) and in chemical reactions, such as the production of ammonia, hydrogen peroxide, hydrochloric acid and methanol [16, Agência Portuguesa do Ambiente 2010], [30, Euro Chlor 2010].

1.5 Environmental relevance of the chlor-alkali industry

The chlor-alkali industry is an energy-intensive industry and consumes large amounts of electricity during the electrolysis process. Additional energy in the form of steam or electricity is necessary for auxiliary processes, which depend on the cell technique used. In 2010, the total electricity consumption of the chlor-alkali sector in the EU-27 and EFTA countries amounted to 35 TWh [13, Euro Chlor 2010]. This was equivalent to 1 % of the total final energy consumption in the form of electricity in this region, to 3 % of all industry sectors and to 17 % of the chemical and petrochemical industry [14, Eurostat 2012].

In 2012, approximately 88 % of the hydrogen produced by chlor-alkali plants in the EU-27 and EFTA countries was used as a chemical reagent or fuel while the remaining 12 % was emitted to air [9, Euro Chlor 2013]. This 12 % corresponds to a total of approximately 33 kt of hydrogen, which represents a higher heating value of approximately 1.3 TWh (higher heating value of hydrogen 142 MJ/kg).

Hydrogen could potentially act as an indirect greenhouse gas [335, IPCC 2007]. A global warming potential of 5.8 over a 100-year time horizon has been reported [334, Derwent et al. 2006]. Hydrogen emissions of 33 kt/yr would therefore correspond to carbon dioxide emissions equivalent to approximately 190 kt/yr.

All three cell techniques (mercury, diaphragm and membrane cell techniques) may give rise to emissions of chlorine to air through leakages during production, handling and storage, as well as through channelled emissions from the chlorine absorption unit. The substances emitted through waste water include free chlorine, chlorate, bromate, chloride, sulphate, heavy metals, sulphite, organic compounds and halogenated organic compounds. Some of these substances are inherent to the process while others originate from impurities in the raw materials.

For many years, the mercury cell technique has been a significant source of environmental pollution, because some mercury is lost from the process to air, water, products and wastes. Most of the mercury which leaves an installation is disposed of with waste. Releases to the environment from the installation mostly occur to the atmosphere as diffuse emissions from the cell room. Significant emissions may also occur during decommissioning of the installation.

In 2010, the total annual mercury emissions to air of the chlor-alkali industry in the EU-27 amounted to approximately 7 % of the total anthropogenic mercury emissions to air in this region. The largest emissions sources were coal combustion (~ 50 %), metal production (~ 17 %) and cement production (~ 15 %) [15, AMAP/UNEP 2013].

Worldwide, the chlor-alkali industry was responsible for 1.4 % of anthropogenic mercury emissions to air in 2010. The largest emissions sources were artisanal and small-scale gold mining (37.1 %), coal combustion (24.2 %), metal production (17.8 %) and cement production (8.8 %) [15, AMAP/UNEP 2013].

There is, however, some uncertainty about mercury emissions from mercury cell plants due to methodological difficulties in quantifying the diffuse emissions and in setting up a mercury input-output balance.

Several policy initiatives and regulations on a European and international level since the 1990s have been aimed at reducing mercury emissions to the environment, starting with the PARCOM Decision 90/3 [90, PARCOM Decision 90/3 1990]. This decision recommended that existing mercury cell plants should be phased out as soon as practicable, with the objective of a complete phase-out by 2010. Moreover, the EU mercury strategy was adopted in 2005 [286, COM 2005], the EU mercury export ban took effect in 2011 [279, Regulation EC/1102/2008 2008] and the Minamata Convention on Mercury was signed in October 2013, including a provision for a global phase-out of the mercury cell technique by 2025 with possibilities for exemptions [108, UNEP 2013]. In 2012, the contracting parties to the Barcelona Convention for Protection

against Pollution in the Mediterranean Sea decided that mercury emissions from chlor-alkali plants from the treaty area should cease by 2020 at the latest [311, UNEP 2012].

In addition to the aforementioned policy initiatives and regulations, the European chlor-alkali producers have committed to phase out the use of the mercury cell technique for the production of chlorine and caustic by 2020 (except for the production of specialities such as alcoholates, dithionites and alkali metals by using alkali metal amalgam) [119, Euro Chlor 2002], [120, Euro Chlor 2005].

Emissions of asbestos are of concern for some diaphragm cell plants. Regulation EC/1907/2006 concerning the Registration, Evaluation, Authorisation and Restriction of Chemicals (REACH), generally prohibits the use of asbestos fibres, but EU Member States can grant an exemption for the use of chrysotile asbestos-containing diaphragms in existing electrolysis installations until they reach the end of their service life, or until suitable asbestos-free substitutes become available, whichever is sooner (ANNEX XVII, number 6.(f)) [287, REACH Regulation (EC) No 1907/2006]. The use of asbestos diaphragms has been prohibited in France and the state of São Paulo (Brazil).

At some sites, historical mercury and PCDD/PCDF contamination of land and waterways from mercury and diaphragm cell plants is a major environmental problem.

Accident prevention and minimising their consequences to the environment is also of major importance for chlor-alkali plants which fall under the scope of the Seveso II and Seveso III Directives if chlorine is present in quantities equal to or in excess of 10 t. The Seveso II Directive is repealed with effect from 1 June 2015 [280, Seveso II Directive (96/82/EC) 1996], [338, Directive 2012/18/EU 2012].

2 APPLIED PROCESSES AND TECHNIQUES

2.1 Overview

In this chapter the applied processes and techniques are qualitatively described. Chapter 3 covers the quantitative aspects of consumption and emission levels.

The chlor-alkali industry produces chlorine and caustic solution (sodium or potassium hydroxide) simultaneously by means of decomposition of a solution of salt (sodium or potassium chloride) in water. Along with the chlorine and the caustic solution, hydrogen is produced. An industrial chlor-alkali production unit comprises a series of operations, typically structured as shown in Figure 2.1.

In the chlor-alkali electrolysis process, a chloride-salt solution is decomposed electrolytically by direct current. Most of the time, sodium chloride is used in the process and less frequently potassium chloride is used (approximately 3–4 % of the chlorine production capacity in the EU-27 and EFTA countries). Due to the much higher raw material costs, potassium chloride is only used when the desired product is potassium hydroxide [3, Euro Chlor 2011].

Sections 2.1 to 2.8 describe the chlor-alkali production process using sodium chloride, while specific aspects concerning the use of potassium chloride are described in Section 2.9.

There are three basic techniques for the electrolytic production of chlorine. The nature of the cathode reaction depends on the specific technique used. These three techniques are the diaphragm (Griesheim cell, 1885), the mercury (Castner–Kellner cell, 1892), and the membrane cell technique (1970). The techniques differ from each other in terms of electrode reactions and in the way the produced chlorine and caustic/hydrogen are kept separate [1, Ullmann's 2006]. A simplified scheme of the three electrolysis cells is shown in Figure 2.2.

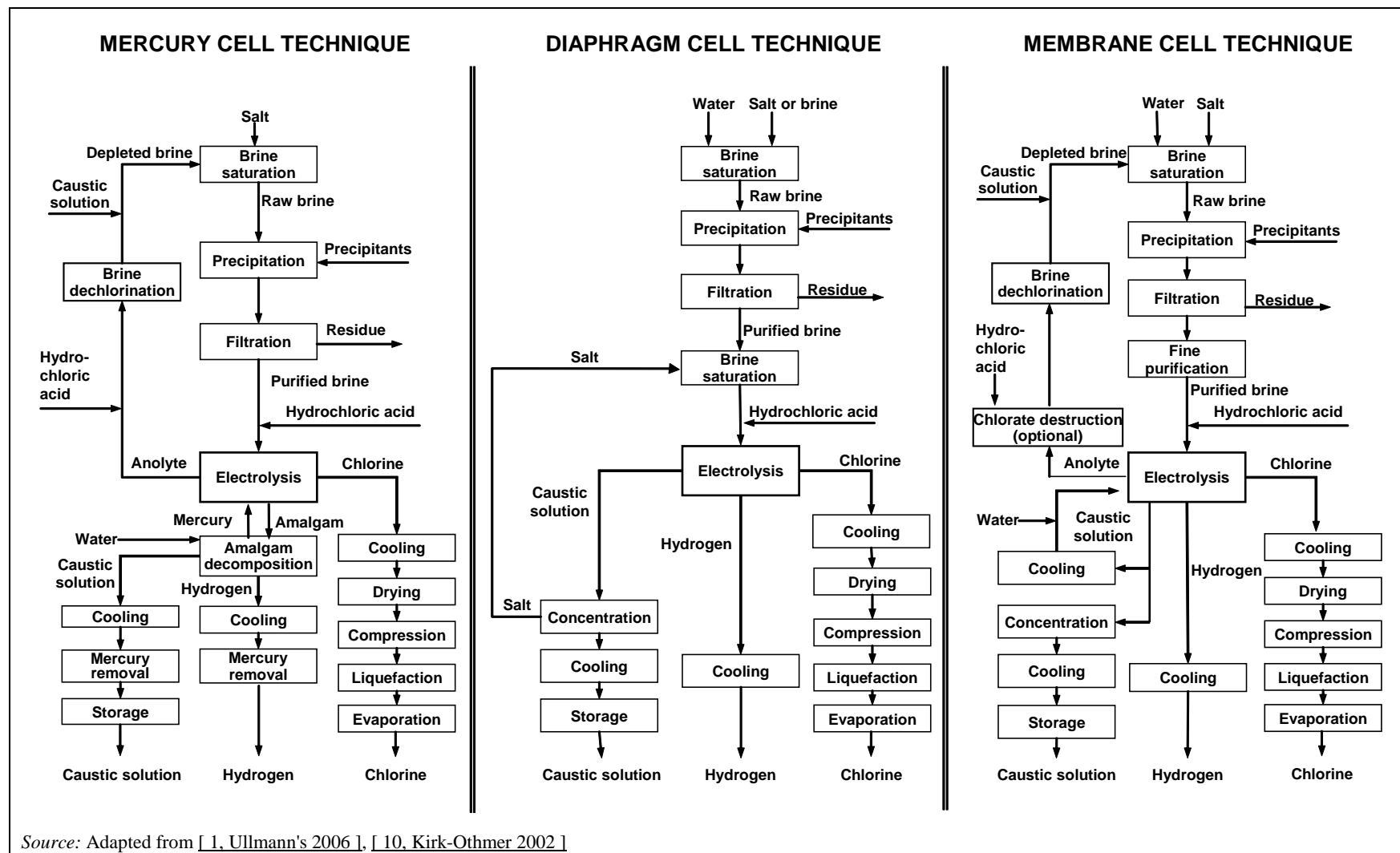

Figure 2.1: Typical flow diagram of the three cell techniques

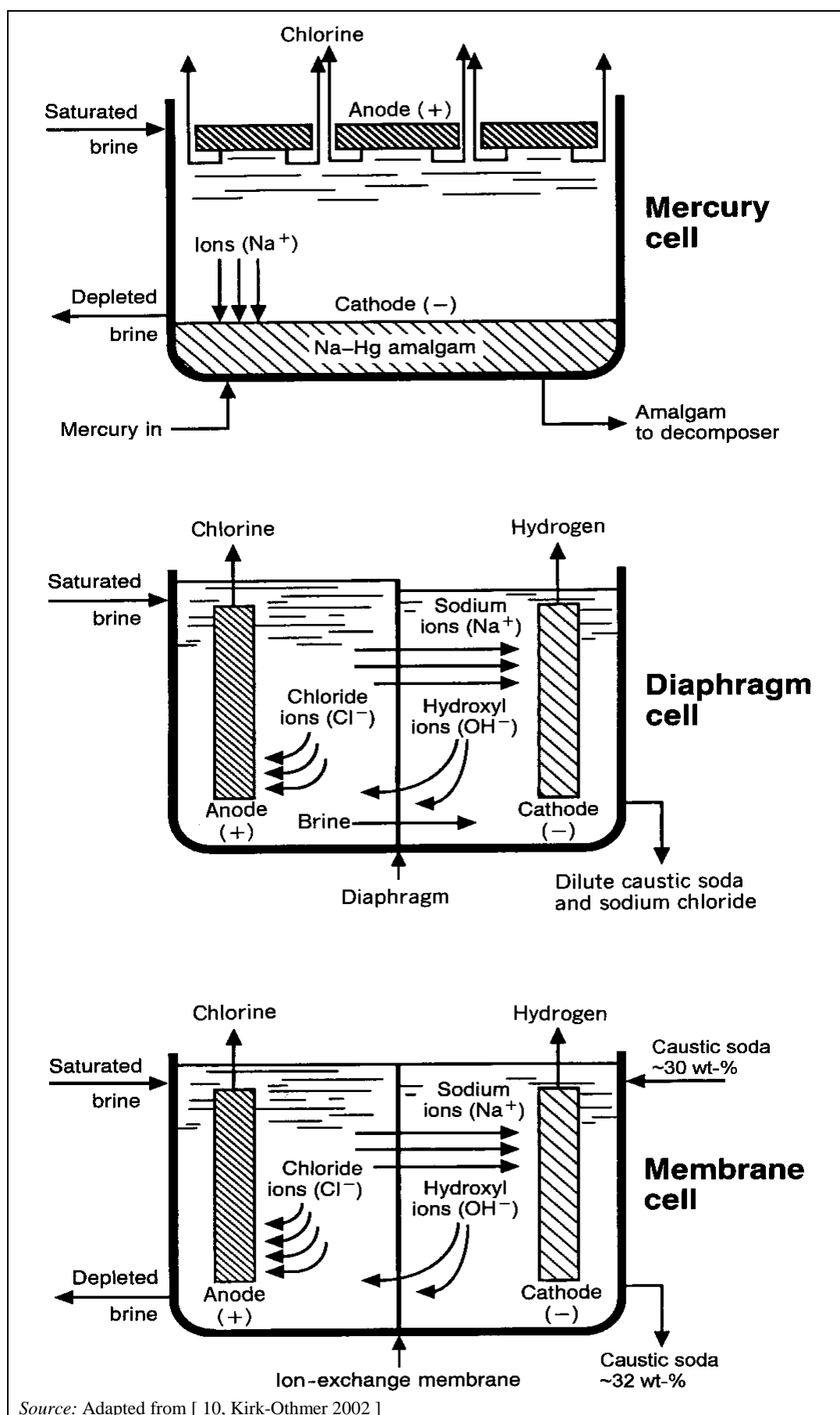
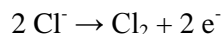

Figure 2.2: Schematic view of chlorine electrolysis cells

The basic principle in the electrolysis of a sodium chloride solution is the following:

- at the anode, chloride ions are oxidised and chlorine (Cl₂) is formed;
- at the cathode: in the mercury cell, a sodium/mercury amalgam is formed; hydrogen (H₂) and hydroxide ions (OH⁻) are subsequently formed by the reaction of the sodium in the amalgam with water in the decomposer; in membrane and diaphragm cells, water decomposes to form hydrogen (H₂) and hydroxide ions (OH⁻) at the cathode.

The anode reaction for all techniques is:



The cathode reaction in mercury cells is:



The reaction in the decomposer is:

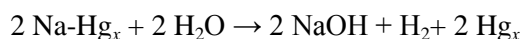

The cathode reaction in membrane and diaphragm cells is:

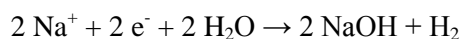

The overall reaction for all techniques is:

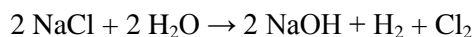

The products of the electrolysis are formed in a fixed ratio, which is 1 070–1 128 kg of NaOH (100 wt-%) and approximately 28 kg of H₂ per tonne of Cl₂ produced. This product combination is often referred to as the electrochemical unit (ECU).

Some side reactions occur during electrolysis, leading to a loss of efficiency [10, Kirk-Othmer 2002]. At the anode, oxidation of water to oxygen and of hypochlorous acid to chlorate takes place:

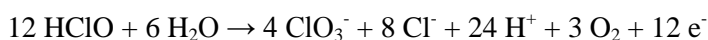
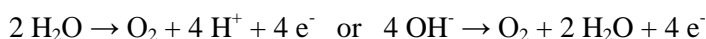

Hypochlorous acid is formed by disproportionation (dismutation) of chlorine in water:



Chlorate is also produced by chemical reactions in the anolyte:

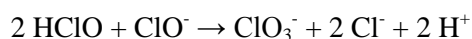

These four major side reactions are repressed by lowering the pH value.

The main characteristics of the three electrolysis techniques are presented in Table 2.1.

Table 2.1: Main typical characteristics of the different electrolysis techniques

Criterion	Mercury	Diaphragm	Membrane
Anode	RuO ₂ + TiO ₂ coating on Ti substrate	RuO ₂ + TiO ₂ + SnO ₂ coating on Ti substrate	RuO ₂ + IrO ₂ + TiO ₂ coating on Ti substrate
Cathode	Mercury	Steel (or steel coated with activated nickel)	Nickel coated with high area nickel-based or noble metal-based coatings
Separator	None	Asbestos, polymer-modified asbestos, or non-asbestos diaphragm	Ion-exchange membrane
Cell voltage	3.15–4.80 V	2.90–3.60 V	2.35–4.00 V
Current density	2.2–14.5 kA/m ²	0.8–2.7 kA/m ²	1.0–6.5 kA/m ²
Temperature	Inlet: 50–75 °C Outlet: 80–90 °C	NI	NI
pH	2–5	2.5–3.5	2–4
Cathode product	Sodium amalgam (Na-Hg _x)	10–12 wt-% NaOH and H ₂	30–33 wt-% NaOH and H ₂
Decomposer product	50 wt-% NaOH and H ₂	No decomposer needed	No decomposer needed
Evaporator product	No evaporation needed	50 wt-% NaOH	50 wt-% NaOH
Quality of caustic soda (50 wt-% NaOH)	NaCl: ~ 50 mg/kg NaClO ₃ : ~ 5 mg/kg Hg: ~ 0.1 mg/kg	NaCl: ~ 10 000 mg/kg (15 000–17 000 mg/kg before concentration) NaClO ₃ : ~ 1 000 mg/kg (400–500 mg/kg before concentration)	NaCl: ~ 50 mg/kg NaClO ₃ : ≤ 10–50 mg/kg
Chlorine quality	O ₂ : 0.1–0.3 vol-% H ₂ : 0.1–0.5 vol-% N ₂ : 0.2–0.5 vol-%	O ₂ : 0.5–2.0 vol-% H ₂ : 0.1–0.5 vol-% N ₂ : 1.0–3.0 vol-%	O ₂ : 0.5–2.0 vol-% H ₂ : 0.03–0.3 vol-%
Advantages	50 wt-% high-purity caustic directly from cell, high-purity chlorine and hydrogen, simple brine purification	Low quality requirements of brine, low electrical energy consumption	Low total energy consumption, low investment and operating costs, no use of mercury or asbestos, high-purity caustic, further improvements expected
Disadvantages	Use of mercury, expensive cell operation, costly environmental protection, large floor space	High steam consumption for caustic concentration in expensive multi-effect evaporators, low-purity caustic, low chlorine quality, some cells are operated with asbestos diaphragms	High-purity brine required, low chlorine quality, high cost of membranes
NB: NI = No information provided.			
Source: [1, Ullmann's 2006], [3, Euro Chlor 2011], [10, Kirk-Othmer 2002], [28, EIPPCB 2011], [58, Euro Chlor 2010]			

2.2 The mercury cell technique

2.2.1 General description

The mercury cell technique has been in use in Europe since 1892. As shown in Figure 2.3, the mercury cell technique includes an electrolysis cell and a horizontal or vertical decomposer. In the electrolysis cell, purified and saturated brine containing approximately 25 wt-% sodium chloride flows through an elongated trough that is slightly inclined. In the bottom of this trough a shallow film of mercury (Hg) flows along the brine cell together with the brine. Closely spaced above the cathode, an anode assembly is suspended [17, Dutch Ministry 1998].

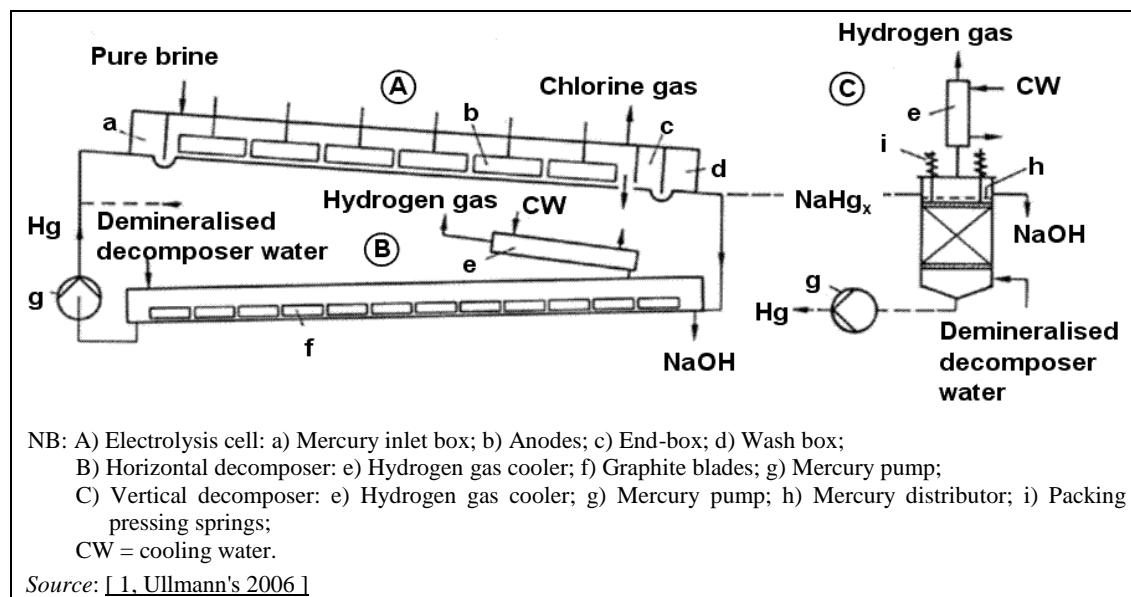

Figure 2.3: Schematic view of a mercury electrolysis cell with horizontal and vertical decomposers

Electric current flowing through the cell decomposes the brine passing through the narrow space between the electrodes, liberating chlorine gas (Cl_2) at the anode and metallic sodium (Na) at the cathode. The chlorine gas is accumulated above the anode assembly and is discharged to the purification process. As it is liberated at the surface of the mercury cathode, the sodium immediately forms an amalgam (NaHg_x). The concentration of the amalgam is maintained at 0.2–0.4 wt-% Na so that the amalgam flows freely. Na concentrations of > 0.5 wt-% can cause increased hydrogen evolution in the cells [1, Ullmann's 2006]. The liquid amalgam flows from the electrolytic cell to a separate reactor, called the decomposer or denuder, where it reacts with water in the presence of a graphite catalyst to form sodium hydroxide and hydrogen gas. The sodium-free mercury is fed back into the cell and is reused.

The depleted brine anolyte leaving the cell is saturated with chlorine and must be partially dechlorinated before being returned to the dissolvers.

The sodium hydroxide is produced from the decomposer at a concentration of approximately 50 wt-%; the maximum value reported is 73 wt-% [1, Ullmann's 2006]. However, there is no plant in the EU-27 and EFTA countries known to be operating above 50 wt-%.

For its operation, the mercury cell depends on the higher overpotential of hydrogen on mercury to achieve the preferential release of sodium rather than hydrogen. However, impurities such as vanadium (V), molybdenum (Mo), and chromium (Cr) at the 0.01–0.1 ppm level and other elements (Al, Ba, Ca, Co, Fe, Mg, Ni, W) at the ppm level that can contaminate the mercury surface may lack this overpotential protection and can cause localised release of hydrogen into

the chlorine. There is a risk that the hydrogen concentration in the chlorine can increase to the point at which the cell and downstream chlorine handling equipment contain explosive mixtures [1, Ullmann's 2006].

Mercury cells are usually operated to maintain a 21–22 wt-% concentration of salt in the spent brine discharged from the cell. This corresponds to the decomposition of 15–16 % of the salt during a single pass. Further salt decomposition to a lower concentration in the brine would decrease brine conductivity, with the attendant loss of electrical efficiency [17, Dutch Ministry 1998]. However, in plants with once-through brine systems, approximately 40 % of the salt is electrolysed in the cells [3, Euro Chlor 2011].

The mercury cell technique has the advantage over the diaphragm and membrane cell techniques that it produces a chlorine gas with nearly no oxygen, and a 50 wt-% caustic soda solution. However, mercury cells operate at a higher voltage (3–5 V) and current density (7–10 kA/m²) than diaphragm and membrane cells and, therefore, use more energy (caustic soda concentration excluded). The technique also requires a pure brine solution with little or no metal contaminants to avoid the risk of explosion through hydrogen generation in the cell. The mercury cell technique inherently gives rise to environmental releases of mercury [1, Ullmann's 2006], [10, Kirk-Othmer 2002].

2.2.2 The cell and the decomposer

The cell is made of an elongated, slightly inclined trough (slope 1.0–2.5 %) and a gas-tight cover. The trough is made of steel, and its sides are lined with a protective, non-conductive rubber coating to prevent contact with the anolyte, to confine brine-cathode contact to the mercury surface, and to avoid the corrosive action of the electrolyte [1, Ullmann's 2006]. Cells are 1–2.5 m wide and 10–25 m long. As a result, the cell area can be greater than 30 m². The size of the cells can vary over a broad range to give the desired chlorine production rate. The steel base is as smooth as possible to ensure mercury flow in an unbroken film. In the event of a break in the mercury surface, caustic soda will be formed on the bare (steel) cathode, with the simultaneous release of hydrogen, which will mix with the chlorine [17, Dutch Ministry 1998]. The cathode is made by a shallow layer of mercury which flows from one extremity of the cell to the other due to the slight inclination of the cell base. The quantity of mercury per cell can be up to 6 t. A high level of purity, ≥ 99.9 wt-% mercury, and very low concentrations of metals, in particular heavy metals, are required [3, Euro Chlor 2011]. Metallic mercury not used in the electrolysis is generally stored in a separate storage area in closed bottles or containers [87, Euro Chlor 2006].

Graphite was exclusively used as the anode for chlorine production for more than 60 years, even though it exhibited high chlorine overpotential and dimensional instability caused by the electrochemical oxidation of carbon to carbon dioxide, and hence led to high energy consumption and the need for frequent maintenance operations. In the late 1960s, anodes of titanium coated with ruthenium dioxide (RuO₂) and titanium dioxide (TiO₂) were developed, the so-called dimensionally stable anodes. The use of RuO₂- and TiO₂-coated metal anodes reduces energy consumption by approximately 10 % compared to graphite and their life expectancy is higher (300–400 t Cl₂ produced/m²; ranging from less than one year to more than five, depending on current density and the gap between the anode and cathode). The anode geometry for mercury cells has been optimised with the aim of improving gas release in order to reduce ohmic losses and increasing the homogeneity of the brine to improve anode coating life [1, Ullmann's 2006], [10, Kirk-Othmer 2002], [21, Kirk-Othmer 1995].

An 'end-box' is attached to each end of the cell. The end-box incorporates compartments for collecting the chlorine gas and weirs for separating the mercury and brine streams, as well as for washing the mercury and permitting the removal of thick mercury 'butter' that is formed by impurities.

The whole cell is insulated from the floor to prevent stray ground currents. Usually, several cells are placed in series by means of electrically connecting the cathode of one cell to the anodes of the next cell. Individual cells can be bypassed for maintenance and replacement. The cells are usually situated in a building (Figure 2.4), although sometimes they are erected in the open air [1, Ullmann's 2006], [17, Dutch Ministry 1998].

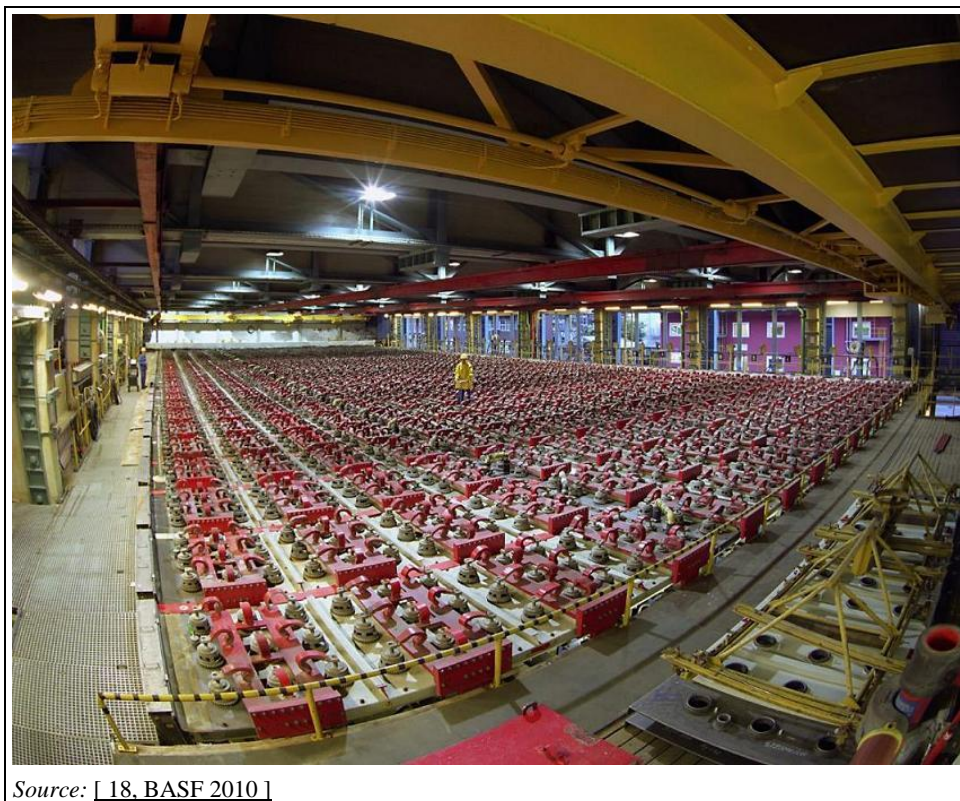

Figure 2.4: View of a mercury cell room

The brine normally enters the electrolysis cell at 60–70 °C. At this temperature, the conductivity of the brine solution and the fluidity of the mercury are higher compared to operation at ambient temperature. The temperature can be achieved by preheating the saturated brine, and is increased in the cell by Joule heating to approximately 75–85 °C. The heat produced during electrolysis and amalgam decomposition requires the air of the cell room to be changed 10–25 times per hour, depending on the type of building [1, Ullmann's 2006], [17, Dutch Ministry 1998].

The amalgam is decomposed in horizontal decomposers, alongside or beneath the cell, or more commonly, since the early 1960s, in vertical decomposers, at one end of the cell. Industrial decomposers are essentially short-circuited electrochemical primary cells in which the graphite catalyst is the cathode and sodium amalgam the anode. The most common catalyst is graphite, usually activated by oxides of iron, nickel or cobalt or by carbides of molybdenum or tungsten. The decomposer operates at a temperature of approximately 90–130 °C, which is caused by the chemical reactions in the decomposer and the input of warm amalgam from the cell. Higher temperatures lead to a lower overpotential of hydrogen on graphite and therefore to a quicker reaction [1, Ullmann's 2006], [17, Dutch Ministry 1998].

2.3 The diaphragm cell technique

2.3.1 General description

The diaphragm cell technique was developed in the 1880s in the United States and was the first commercial technique used to produce chlorine and caustic soda from brine. The technique differs from the mercury cell technique in that all reactions take place within one cell and the cell effluent contains both dissolved salt and caustic soda. A diaphragm is employed to separate the chlorine liberated at the anode, and the hydrogen and caustic soda produced directly at the cathode (Figure 2.2). Without the diaphragm to isolate them, the hydrogen and chlorine would spontaneously ignite and the caustic soda and chlorine would react to form sodium hypochlorite (NaClO), with a further reaction producing sodium chlorate (NaClO_3) [17, Dutch Ministry 1998].

The diaphragm separates the feed brine (anolyte) from the caustic-containing catholyte. Purified brine enters the anode compartment and percolates through the diaphragm into the cathode chamber. The percolation rate is controlled by maintaining a higher liquid level in the anode compartment to establish a positive and carefully controlled hydrostatic head. The percolation rate is controlled to maintain a balance between a low rate, which would produce a desirably high concentration of caustic soda in the catholyte (which provides the cell effluent), and a high rate to limit back-migration of hydroxyl ions from the catholyte to the anolyte, which would decrease the cathode current efficiency [17, Dutch Ministry 1998].

Diaphragm cells generally produce cell liquor that contains 10–12 wt-% NaOH and 15–17 wt-% NaCl . Generally, this solution is evaporated to 50 wt-% NaOH [10, Kirk-Othmer 2002]. The caustic liquor produced may contain lower concentrations of approximately 7 wt-% NaCl if it is used directly without further concentration [300, Euro Chlor 2011]. During evaporation, most of the sodium chloride precipitates, except a residual of approximately 1.0 wt-%. The salt generated is very pure and is typically used to make more brine [10, Kirk-Othmer 2002]. This high quality sodium chloride is sometimes used as a raw material for mercury or membrane cells. A flow diagram of a possible integrated plant is shown in Figure 2.5.

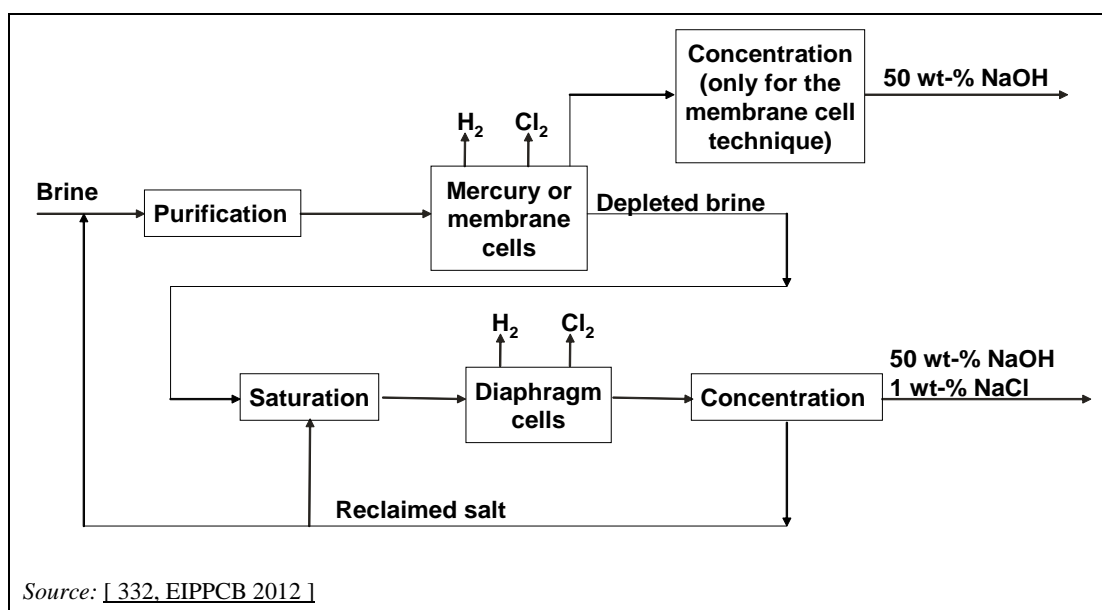

Figure 2.5: Flow diagram of the integration of the membrane or mercury and the diaphragm cell techniques

Low concentrations of oxygen (0.5–2.0 vol-%) in chlorine are formed by the electrolytic decomposition of water. Furthermore, chlorate is formed in the cell liquor by anodic oxidation

and the disproportionation of hypochlorous acid (Section 2.1) (0.04–0.05 wt-% before concentration, ~ 0.1 wt-% after concentration) [10, Kirk-Othmer 2002].

In the diaphragm cell, saturated brine (approximately 25 wt-% NaCl) is decomposed to approximately 50 % of its original concentration in a passage through the cell, compared to a 16 % decomposition of salt per passage through mercury cells. Heating caused by the passage of a current through the liquids raises the operating temperature of the electrolyte to 80–99 °C [17, Dutch Ministry 1998].

The advantages of diaphragm cells are that the quality requirements for the brine and the electrical energy consumption are low (cell voltage 3–4 V; current density 0.5–3 kA/m²). However, a high amount of steam may be necessary for the caustic soda concentration, and the quality of the caustic soda and chlorine produced are low.

When using asbestos diaphragms, the diaphragm cell technique inherently gives rise to the release of asbestos [10, Kirk-Othmer 2002].

2.3.2 The cell

Various designs of diaphragm cells have been developed and used in commercial operations. Figure 2.6 shows a schematic view of a typical monopolar diaphragm cell and Figure 2.7 shows an example of a monopolar diaphragm cell room. Typical anode areas per cell range from 20 to 100 m² [1, Ullmann's 2006].

Cathodes used in diaphragm cells consist of carbon steel with an active coating which lowers the hydrogen overpotential, thus providing significant energy savings. The coatings consist of two or more components. At least one of the components is leached out in caustic to leave a highly porous nickel surface [1, Ullmann's 2006]. The coatings have to be robust, as a powerful water jet is used to remove the diaphragm at the end of its lifetime from the cathode mesh, which can adversely affect the coatings.

Anodes used in diaphragm cells consist of titanium coated with a mixture of ruthenium dioxide, titanium dioxide and tin dioxide. The lifetime of the coatings is at least 12 years [10, Kirk-Othmer 2002]. The most commercially accepted design is that of an expandable anode, which allows compression of the anode structure during cell assembly and expansion when the cathode is in position. The spacers initially placed over the cathode create a controlled gap of a few millimetres between the anode and cathode. Minimisation of the gap leads to a reduced power consumption [21, Kirk-Othmer 1995].

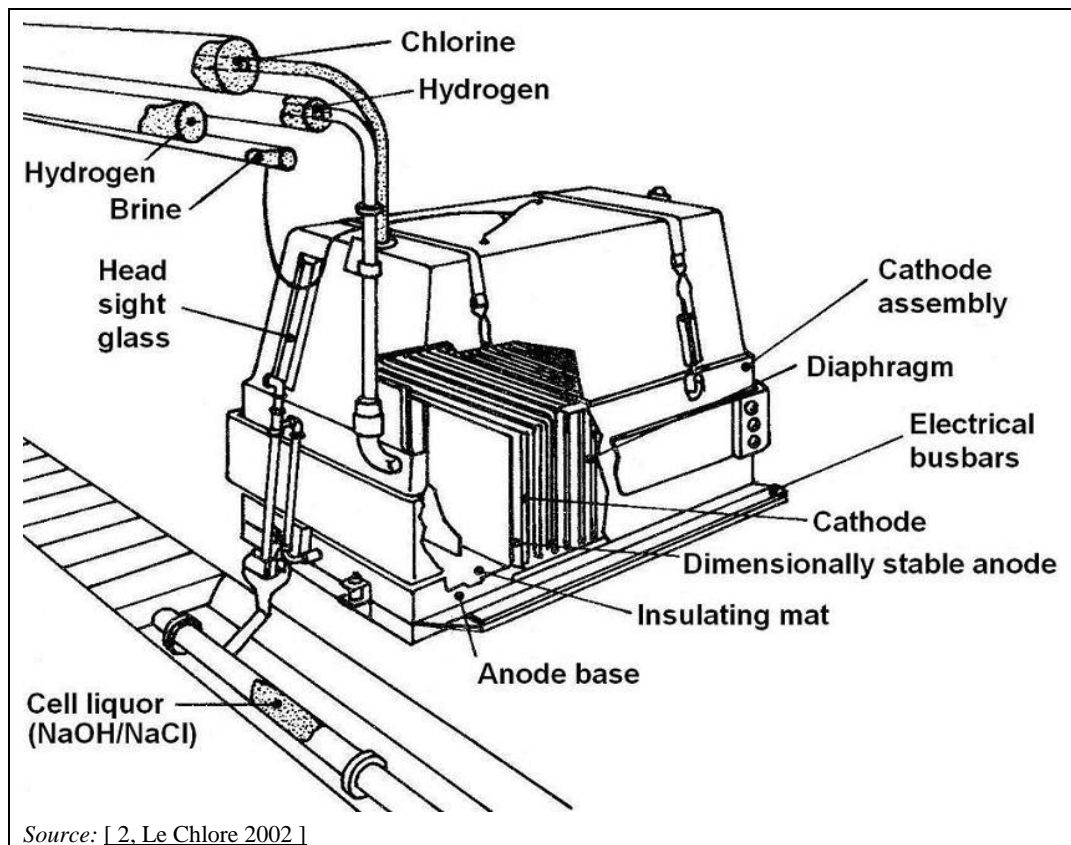

Figure 2.6: Schematic view of a typical monopolar diaphragm cell



Figure 2.7: View of an open-air diaphragm cell room equipped with monopolar electrolyzers

Formerly, when graphite anodes were used, the diaphragm became inoperable after 90–100 days due to clogging by graphite particles. As of 2011, all plants use metal anodes and the lifetime of

the diaphragm can be several years. Their service life has also increased due to a change in composition. The earliest diaphragms were made of sheets of asbestos paper, but in the late 1920s these were replaced by the deposited asbestos diaphragm. Pure asbestos diaphragms suffered from rapid clogging by calcium and magnesium ions from the brine. Asbestos was chosen because of its good chemical and mechanical stability and because it is a relatively inexpensive and abundant material. Beginning in the early 1970s, pure asbestos diaphragms began to be replaced by diaphragms containing a minimum of 75 % asbestos and up to 25 % fibrous fluorocarbon polymer with high chemical resistance. These Polymer Modified Asbestos (PMA) diaphragms are more stable, as the polymer stabilises the asbestos, which in turn lowers the cell voltage and also allows for the use of an expandable anode [1, Ullmann's 2006]. Chrysotile asbestos ('white asbestos') is the only form of asbestos used in diaphragm cells.

Due to the potential exposure of employees to asbestos and emissions to the environment, efforts have been made to replace the asbestos with other diaphragm materials.

The development of non-asbestos diaphragms started in the mid-1980s. Two non-asbestos diaphragm systems were commercially available in 2010. The basis of the material used is the same in all asbestos-free diaphragms, i.e. a fluorocarbon polymer, mainly PTFE (polytetrafluoroethylene). The differences lie in the fillers used and the way the hydrophobic PTFE fibres are treated and deposited in order to form a permeable and hydrophilic diaphragm (Section 4.2.2) [31, Euro Chlor 2010].

In 2013, only one plant in the EU-27 was still using asbestos diaphragms: Dow in Stade (Germany). All three diaphragm cell plants in France (Kem One (formerly Arkema) in Fos-sur-Mer and Lavéra, and Vencorex (formerly Perstorp) in Le Pont de Claix) have been operating with asbestos-free diaphragms since 2003. Additionally, the Solvay plant in Rheinberg (Germany) converted to asbestos-free diaphragms in 2012. The Zachem plant in Bydgoszcz (Poland) was shut down in 2012 [298, Euro Chlor 2013].

A commercial plant has multiple cell elements combined into a single unit, called the electrolyser. Both diaphragm and membrane electrolysers are classified as either monopolar or bipolar. This is described in detail in Section 2.4.3. There are many more monopolar diaphragm electrolysers in chlor-alkali production facilities than there are bipolar electrolysers [1, Ullmann's 2006].

2.4 The membrane cell technique

2.4.1 General description

At the beginning of the 1970s, the development of the first ion-exchange membranes introduced a new technique to produce chlorine: the membrane cell technique. The first industrial membrane cell plant was installed in Japan in 1975. Due to the pressure of Japanese environmental regulations in the aftermath of the Minamata disease, caused by waste water contaminated with methylmercury which had been discharged in the 1950s into Minamata Bay, Japan was the first country where the technique was installed on a wide scale in the mid-1980s. Since the 1990s, the membrane cell technique is considered the state-of-the-art technique for producing chlorine and caustic soda/potash [1, Ullmann's 2006].

In this technique, the anode and cathode are separated by an ion-conducting membrane (Figure 2.2). Brine solution flows through the anode compartment, where chloride ions are oxidised to chlorine gas. The sodium ions, together with approximately 3.5 to 4.5 moles of water per mole of sodium, migrate through the membrane to the cathode compartment, which contains a caustic soda solution [1, Ullmann's 2006]. The water is electrolysed at the cathode, releasing hydrogen gas and hydroxide ions. The sodium and hydroxide ions combine to produce caustic soda, which is typically kept at 32 ± 1 wt-% in the cell by diluting a part of the product stream with demineralised water to a concentration of approximately 30 wt-% and subsequent recycling to the catholyte inlet (Figure 2.1). Caustic soda is continuously removed from the circuit. Depleted brine is discharged from the anode compartment and resaturated with salt. The membrane largely prevents the migration of chloride ions from the anode compartment to the cathode compartment; therefore, the caustic soda solution produced contains little sodium chloride (i.e. approximately 50 mg/l). Back-migration of hydroxide is also largely prevented by the membrane but nevertheless takes place to a certain extent and increases the formation of oxygen, hypochlorite and chlorate in the anode compartment, thereby resulting in a loss of current efficiency of 3–7 % with respect to caustic soda production [1, Ullmann's 2006], [10, Kirk-Othmer 2002], [22, Uhde 2009].

Some electrolyzers produce a more diluted 23–24 wt-% caustic soda. In this case, the caustic entering the cell has a concentration of approximately 20–21 wt-% and the heat of the electrolysis can be used to concentrate the 23–24 wt-% caustic solution to 32–34 wt-%. The overall energy efficiency is comparable to the aforementioned process with the 32 wt-% caustic solution but more equipment is required for the caustic evaporation. On the other hand, simpler and cheaper construction materials can be used in the caustic circuit around the membrane cells [3, Euro Chlor 2011], [300, Euro Chlor 2011].

Generally, the caustic produced in a concentration of 30–33 wt-% is concentrated to the usual commercial standard concentration of 50 wt-% by evaporation (using steam). Another possibility is to use the caustic produced in the membrane cells as feed to the decomposers of mercury cells. A flow diagram of a possible integrated plant is shown in Figure 2.8.

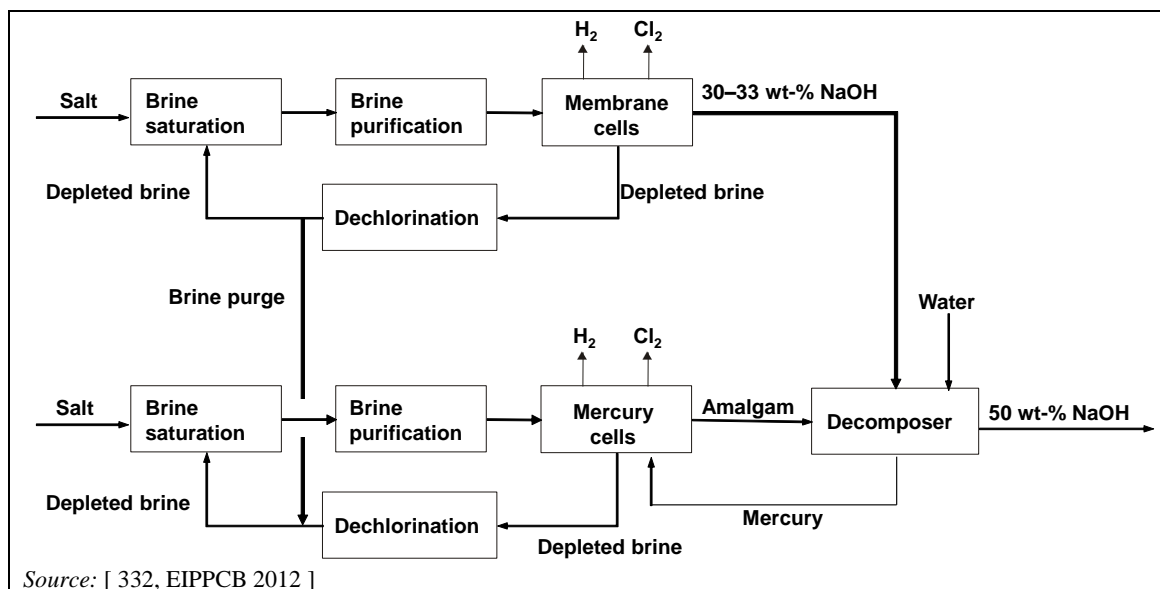

Figure 2.8: Flow diagram of the integration of the membrane and mercury cell techniques

The concentration of sodium chlorate in the produced caustic soda typically ranges from ≤ 10 to 50 mg/kg [28, EIPPCB 2011]. The level depends on the membrane characteristics, the operational current density and the chlorate levels in the brine [3, Euro Chlor 2011]. The chlorine produced in membrane cells contains low concentrations of oxygen (0.5–2.0 vol-%). The formation of oxygen and chlorate can be depressed by selecting an anode coating with suitable characteristics and/or by decreasing the pH in the anode compartment [1, Ullmann's 2006], [10, Kirk-Othmer 2002].

Brine depletion in membrane cells is two or three times greater than in mercury cells, which allows the brine system to be smaller, resulting in significantly lower recycling rates and less equipment needed compared to mercury cell plants of the same capacity [1, Ullmann's 2006], [22, Uhde 2009].

The membrane cell technique has the advantage of producing a very pure caustic soda solution and of using less energy than the other techniques. In addition, the membrane cell technique uses neither mercury, which is classified as very toxic, nor asbestos, which is classified as toxic (carcinogenic) [76, Regulation EC/1272/2008 2008]. Disadvantages of the membrane cell technique are that the caustic soda produced may need to be evaporated to increase its concentration and, for some applications, the chlorine gas produced needs to be processed to remove oxygen, usually by liquefaction and evaporation. Furthermore, the brine entering a membrane cell must be of a very high purity, which requires additional purification steps prior to electrolysis (Section 2.5.3.3) [1, Ullmann's 2006], [10, Kirk-Othmer 2002].

2.4.2 The cell

Various designs of membrane cells have been developed and used in commercial operations. Figure 2.9 shows a schematic view of a typical bipolar membrane electrolysis cell, Figure 2.10 shows an example of a bipolar membrane cell room and Figure 2.11 shows an example of a monopolar membrane cell room.

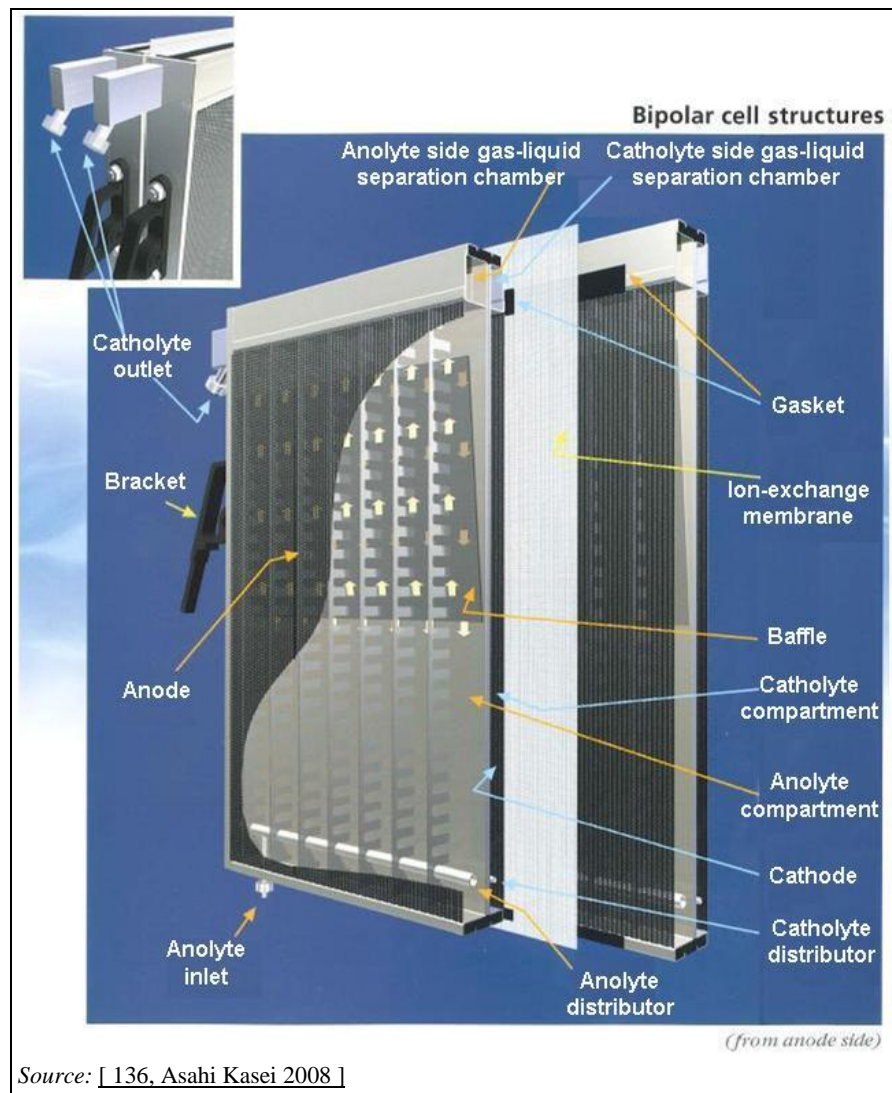
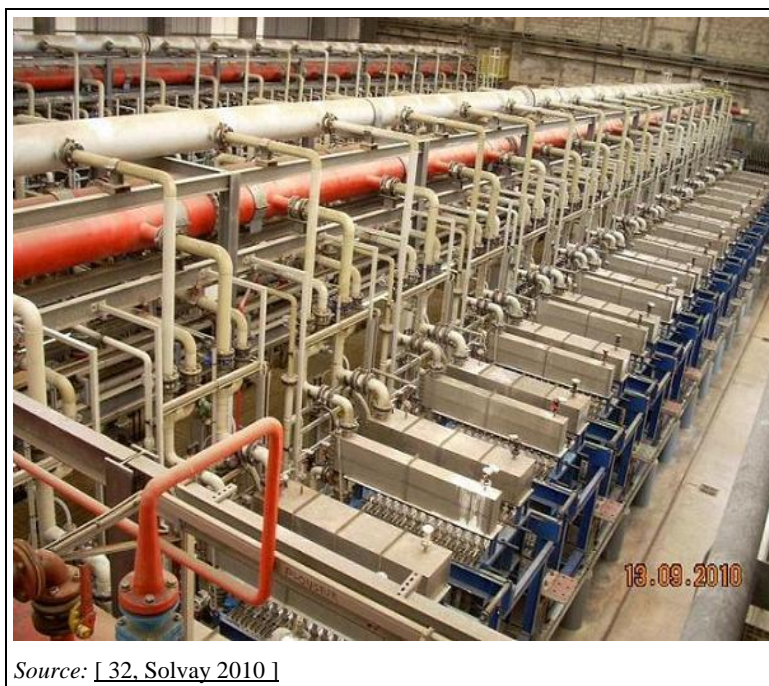

Figure 2.9: Schematic view of a typical bipolar membrane electrolysis cell



Figure 2.10: View of a membrane cell room equipped with bipolar electrolyzers



Source: [32, Solvay 2010]

Figure 2.11: View of a membrane cell room equipped with monopolar electrolysers

The cathode material used in membrane cells is nickel. Like the cathodes of diaphragm cells, they are often coated with a catalyst that is more stable than the substrate and which increases surface area and reduces the overpotential. Coating materials include Ni-S, Ni-Al, and Ni-NiO mixtures, as well as mixtures of nickel and platinum group metals. The cathode coatings for membrane cells have to be more chemically resistant than those of diaphragm cells, because of the higher caustic concentration.

The anodes used consist of titanium coated with a mixture of ruthenium dioxide, titanium dioxide and iridium dioxide. At the beginning of the 21st century, the second-generation coatings for membrane cells showed lifetimes comparable to those of the diaphragm cell technique [1, Ullmann's 2006], [10, Kirk-Othmer 2002].

The membranes used in the chlor-alkali industry are commonly made of perfluorinated polymers. The membranes may have one to three layers, but generally consist of two layers (Figure 2.12). One of these layers consists of a perfluorinated polymer with substituted carboxylic groups and is adjacent to the cathodic side. The other layer consists of a perfluorinated polymer with substituted sulphonic groups and is adjacent to the anodic side. The carboxylate layer exhibits a high selectivity for the transport of sodium and potassium ions and largely prevents the transport of hydroxide, chloride, hypochlorite, and chlorate ions, while the sulphonate layer ensures good mechanical strength and a high electrical conductivity. To give the membrane additional mechanical strength, it is generally reinforced with PTFE fibres. The membranes must remain stable while being exposed to chlorine on one side and a strong caustic solution on the other. Commercially available membranes are optimised for use in a specific strength of caustic. Depending on the particular design, membrane sizes range from 0.2 to 5 m². The general economic lifetime of chlor-alkali membranes is approximately three to five years [1, Ullmann's 2006], [26, Euro Chlor 2010].

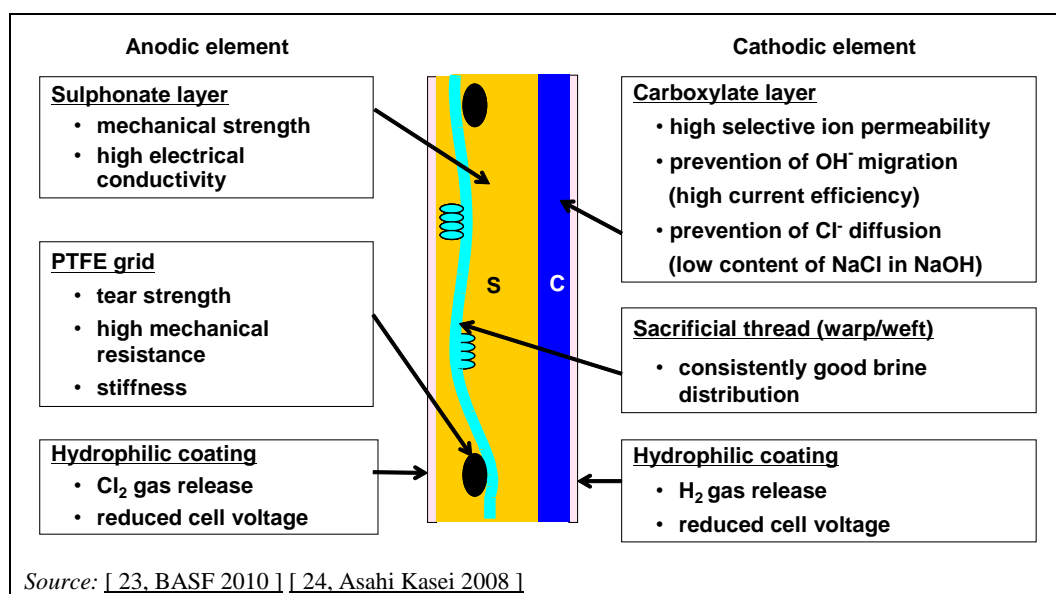

Figure 2.12: Schematic view of a membrane

In the design of a membrane cell, minimisation of the voltage drop across the electrolyte is accomplished by bringing the electrodes close together. However, when the gap is very small, the voltage increases because of the entrapment of gas bubbles between the electrodes and the hydrophobic membrane. This effect is avoided by coating both sides of the membrane with a thin layer of a porous inorganic material to enhance the membrane's ability to release the gaseous products from its surface. These improved membranes have allowed for the development of modern cells with zero-gap or finite-gap cathode structures [10, Kirk-Othmer 2002], [26, Euro Chlor 2010].

2.4.3 Monopolar and bipolar electrolysers

Electrolysers containing a multitude of membrane or diaphragm cells are classified as either monopolar or bipolar. The designation does not refer to the electrochemical reactions that take place, which of course require two poles or electrodes for all cells, but to the electrolyser construction or assembly. In a bipolar arrangement, the elements are connected in series with a resultant low current and high voltage (Kirchhoff's circuit laws). The cathode of a cell is connected directly to the anode of the adjacent cell (Figure 2.13). In the monopolar arrangement, all anodes and cathodes are connected in parallel, forming an electrolyser with a high current and low voltage. The current has to be connected to every single anodic and cathodic element, while in a bipolar electrolyser the power supply is connected only to the end part of the electrolyser. Due to the long current path, ohmic losses in monopolar electrolysers are much higher than in equivalent bipolar electrolysers, leading to increased energy consumption [1, Ullmann's 2006].

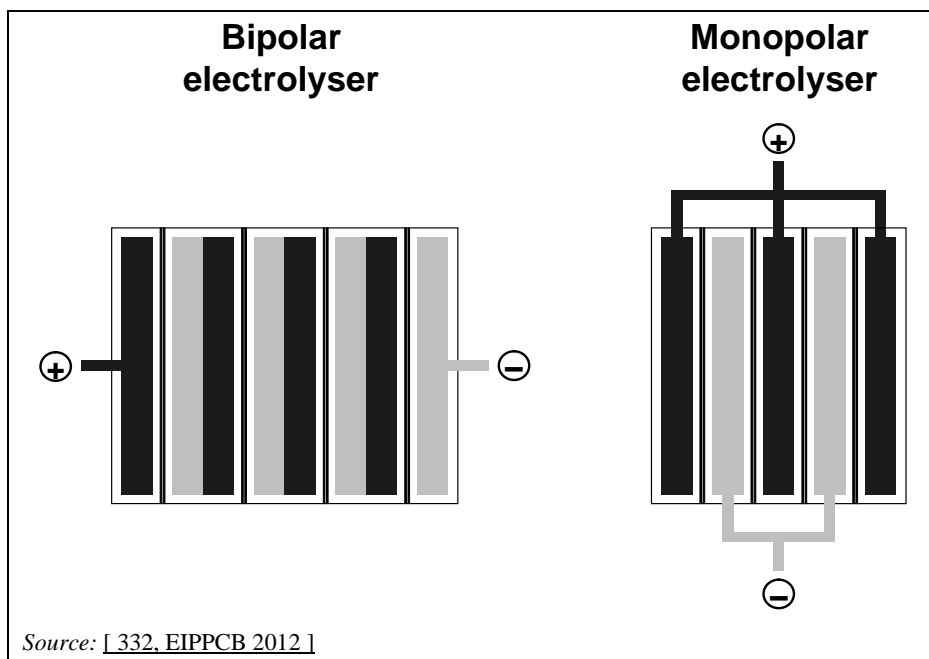

Figure 2.13: Simplified scheme of monopolar and bipolar electrolyzers

Multiple electrolyzers are employed in a single direct current circuit (Figure 2.14). Usually bipolar electrolyzers are connected in parallel with a low current and high voltage. Monopolar electrolyzers are often connected in series, resulting in a high current circuit and low voltage [1, Ullmann's 2006].

Table 2.2 shows the differences between typical configurations of monopolar and bipolar membrane cell plants with the same production capacity. Monopolar membrane cell plants are characterised by a larger number of electrolyzers while the number of cells per electrolyser is lower than in a bipolar membrane cell plant.

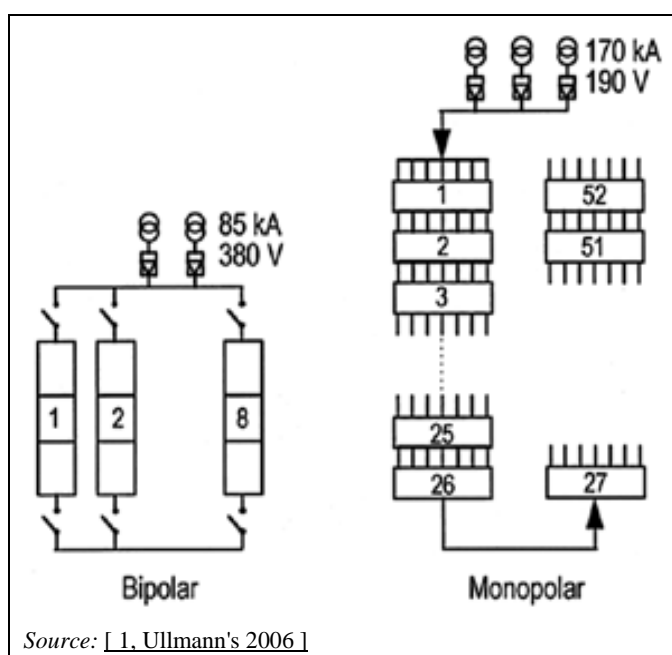

Figure 2.14: Electrolyser architecture

Table 2.2: Typical configurations of a monopolar and a bipolar membrane cell plant

Parameter	Unit	Monopolar configuration	Bipolar configuration
Current density	kA/m ²	3.7	6.0
Active membrane area	m ²	1.75	2.70
Cells per electrolyser	—	34	181
Load per electrolyser	kA	220	16.2
Electrolyser number	—	67	5
Chlorine capacity	kt/yr	158	158
Cell voltage	V	3.6	3.2
Cell room voltage	V	240	580
Electricity consumption	DC kWh /t Cl ₂ produced	2 860	2 600
<i>Source: [26, Euro Chlor 2010]</i>			

The maximum current density of an electrolyser is determined by the resistance (ion conductivity) of the membrane and the hydraulic conditions of the cells (elimination of the gas formed). The first monopolar electrolysers worked at maximum current densities of 4 kA/m² but bipolar electrolysers can now be operated at current densities of 6–7 kA/m² and pilot cells are currently tested at up to 10 kA/m². The trend to develop higher current density electrolysers aims to reduce investment costs while developments in membranes, electrolysis technology such as anode-cathode gap reduction and catalyst developments strive to reduce energy consumption [63, Euro Chlor 2011].

In 2011, monopolar membrane electrolysers were only commercialised to maintain existing plants and for new plants with small capacities. That change is due to the following advantages of bipolar electrolysers which lead to reduced investment and operating costs, as well as to improved safety [26, Euro Chlor 2010]:

- easier manufacturing;
- smaller copper busbars due to the lower current; the only copper current distributors needed are the main busbars connected to the end parts of the electrolyser;
- possibility to operate at higher current density without dramatic effects on energy consumption due to very efficient internal recirculation;
- membrane area more effectively used (from 85–87 % to 90–92 %);
- better energy performance due to smaller voltage drop;
- no need for spare bipolar electrolyser (only some spare individual cells are necessary, compared to spare electrolysers required for the monopolar technique);
- shorter duration of shutdown and start-up phases to replace membranes due to the easy and simple filter press design;
- higher flexibility of operation (each electrolyser could be operated independently of the others due to a parallel connection); no need for expensive mobile short-circuit switches for the isolation of troubled electrolysers (Figure 2.14);
- new possibility to operate bipolar electrolysers under slight pressure on the chlorine side (no need for a blower);
- easier detection of faulty cells by monitoring of individual cell voltages.

2.5 Brine supply

2.5.1 Sources, qualities and storage of salt

The brine used in mercury and membrane cells is normally obtained by dissolving solid salt in depleted brine, although some installations use solution-mined brine on a once-through basis (i.e. no brine recirculation). The brine supply for diaphragm cells is always used on a once-through basis, most commonly using solution-mined brine, although the salt recovered from the caustic evaporators may be recycled into the brine supply (Figure 2.1).

The basic raw material is usually solid salt: rock salt obtained by mechanical mining; solar salt produced by solar evaporation of seawater or brine; or vacuum salt from purifying and evaporating solution-mined brine. Other sources include salt recovered from the caustic evaporators of the diaphragm cell technique and solution-mined brine obtained by forcing water or weak brine into a salt deposit to dissolve the material and carry it back to the surface [1, Ullmann's 2006], [10, Kirk-Othmer 2002]. Another source is used in Spain where 70 % of the sodium chloride used in chlor-alkali plants is obtained by purification of NaCl-containing wastes from the mining of potash (KCl), including wastes from historic landfills [27, ANE 2010]. In specific cases, it is also possible to recycle salt-containing waste water from other production processes [33, Euro Chlor 2011].

In the EU-27 and EFTA countries in 2011, mercury cell plants mostly used vacuum salt and rock salt, diaphragm cell plants used solution-mined brine and membrane cell plants mostly used vacuum salt and to a lesser extent solution-mined brine and rock salt. Solar salt was only used by a few plants in Southern Europe, and salt from potash mining wastes by plants in Spain. Some plants used a combination of salt types [57, CAK TWG 2012].

The compositions from different sources vary widely but the main impurity in nearly all salts is some form of calcium sulphate (Table 2.3). Solar salt is usually purer than rock salt, at least after the common operation of washing. However, it is more susceptible to caking and mechanical degradation. Rock salt usually contains more calcium sulphate and proportionately less magnesium. The higher ratio of calcium to magnesium improves the precipitation of magnesium hydroxide due to the formation of hybrid particles. Many chlor-alkali plants operate with salt that has already undergone some purification. For example, most solar salts are washed to remove occluded liquor and surface impurities, and vacuum salt is recrystallised from brine after most of the impurities have been removed by chemical treatment [10, Kirk-Othmer 2002]. The composition of the salt obtained by purification of potash mining wastes in Spain is within the composition range of rock salt in Table 2.3 [27, ANE 2010]. Compositions similar to rock salt can also be expected for salt obtained from solution mining, except that this salt contains much lower levels of insoluble compounds [293, Euro Chlor 2012].

Table 2.3: Typical compositions of sodium chloride used in chlor-alkali electrolysis

Component	Salt source ⁽¹⁾		
	Rock salt	Washed solar salt	Vacuum salt
NaCl	93–99 %	99 %	99.95 %
SO ₄ ²⁻	0.2–1 %	0.2 %	0.04 %
Ca ²⁺	0.05–0.4 %	0.04 %	0.001 2 %
Mg ²⁺	0.01–0.1 %	0.01 %	0.000 1 %

⁽¹⁾ Compositions are given on a dry basis.
Source: [10, Kirk-Othmer 2002]

Generally the salt is stored in a sealed area equipped with a roof to prevent it from blowing off site. Protective systems are installed to prevent contamination, in particular in case of rain or if

the storage area is located near surface water or groundwater. Because of its high purity, vacuum salt in particular needs to be protected. Anti-caking agents, mostly ferrocyanides, are almost always added to prevent caking of vacuum salt, but rarely for rock salt.

Solution-mined brine is sometimes transported by pipelines over distances which can exceed 100 km. The brine is kept in storage tanks [1, Ullmann's 2006].

2.5.2 Brine preparation

When solid salt is the raw material, a dissolving operation becomes necessary, and this may be carried out in open or closed vessels. The water and/or depleted brine can be sprayed onto the salt or introduced at the base of the saturator for progressive saturation when running through it. In the latter case, the saturated brine overflows the equipment at the top. Modern saturators are closed vessels to reduce emissions of salt spray or mist, as well as of mercury in the case of the mercury cell technique. NaCl concentrations in the saturated brine reach values of 310–315 g/l [1, Ullmann's 2006].

2.5.3 Brine purification

2.5.3.1 General description

As can be seen in Figure 2.1, the brine purification process consists of a primary system for all three cell techniques consisting of precipitation and filtration and an additional secondary system for the membrane cell technique. The brine purification is needed to reduce the concentration of undesirable components (sulphate anions, cations of Ca, Mg, Ba and metals) that could affect the electrolytic process. The quality of the raw material and the brine quality requirements for each of the three techniques determine the complexity of the brine treatment unit.

2.5.3.2 Primary purification

The initial stage of purification uses sodium carbonate and sodium hydroxide to precipitate calcium and magnesium ions as calcium carbonate (CaCO_3) and magnesium hydroxide ($\text{Mg}(\text{OH})_2$). Metals (iron, titanium, molybdenum, nickel, chromium, vanadium, tungsten) may also precipitate as hydroxide during this operation. The usual way to reduce the concentrations of metals is to specify maximum concentration values in the purchase specifications for the salt. Sodium sulphate can be controlled by adding calcium chloride (CaCl_2) or barium salts (BaCO_3 or BaCl_2) to remove sulphate anions by the precipitation of calcium sulphate (CaSO_4) or barium sulphate (BaSO_4). The precipitation of barium sulphate can take place simultaneously with the precipitation of calcium carbonate and magnesium hydroxide, whereas the precipitation of calcium sulphate requires a separate vessel.

When vacuum salt is used as raw material, only a part of the brine stream might be treated in the primary purification unit, while the total stream is usually treated when using other salt types [3, Euro Chlor 2011]. Some plants using vacuum salt omit primary brine purification completely [57, CAK TWG 2012].

The precipitated impurities are removed by sedimentation, filtration or a combination of both. The separated filter cake is generally concentrated to 50–60 % solids content in filter presses, rotary drum vacuum filters or centrifuges before disposal.

The sulphate content can also be reduced without the use of expensive barium salts by purging a part of the brine, by cooling the brine stream and crystallising $\text{Na}_2\text{SO}_4 \cdot 10 \text{H}_2\text{O}$, by precipitating the double salt $\text{Na}_2\text{SO}_4 \cdot \text{CaSO}_4$, by ion exchange, or by nanofiltration combined with purging of

the brine. In the diaphragm cell technique, the removal of sulphate is not always necessary because sulphate can be removed from the cell liquor as pure Na_2SO_4 during the concentration process [1, Ullmann's 2006]. In the case of the membrane cell technique, the use of barium salts is generally avoided to protect the membrane against potential precipitations (Table 2.4) [3, Euro Chlor 2011].

The purified brine should ideally contain [1, Ullmann's 2006]:

- Calcium (Ca^{2+}): < 2 mg/l;
- Magnesium (Mg^{2+}): < 1 mg/l;
- Sulphate (SO_4^{2-}): < 5 g/l.

Before the brine enters mercury or diaphragm electrolysis cells, it is usually acidified with hydrochloric acid to $\text{pH} < 6$, which increases the lifetime of the anode coating and reduces the formation of oxygen, hypochlorite and chlorate [1, Ullmann's 2006].

2.5.3.3 Secondary purification: membrane cell technique

To maintain the high performance of the ion-exchange membrane, the feed brine must be purified to a greater degree than in the mercury or diaphragm cell techniques.

The precipitation step alone is not enough to reduce the levels of calcium and magnesium, and additional softening is thus required. Figure 2.15 shows the flow diagram of a possible layout for the brine system used in the membrane cell technique.

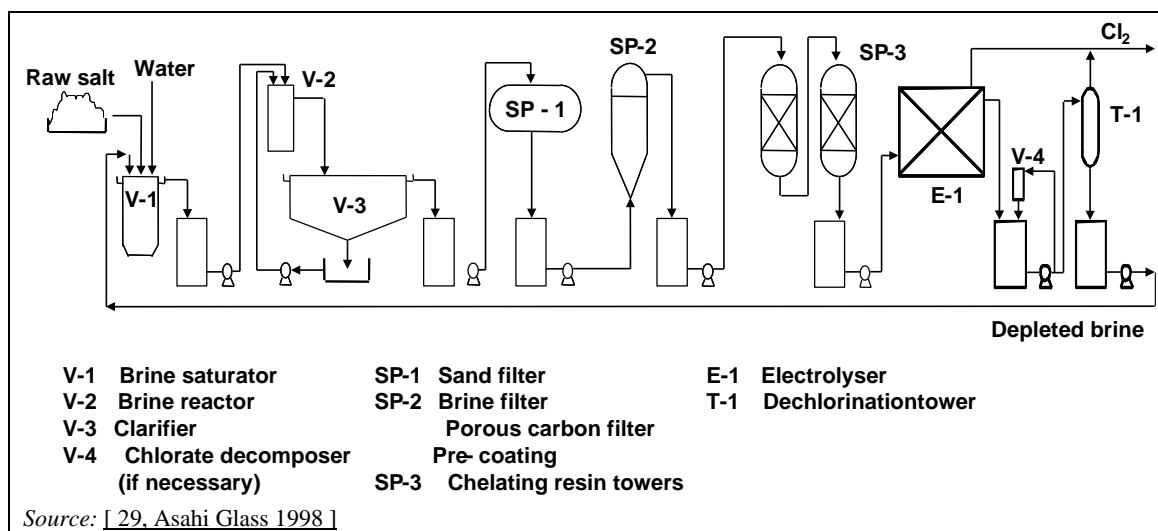

Figure 2.15: Flow diagram of a possible layout for the brine system used in the membrane cell technique

Secondary brine purification generally consists of polishing filtration (Figure 2.16) and brine softening in an ion-exchange unit (Figure 2.17).

The polishing filtration generally consists of candle-type, plate frame or pressure leaf filters (either with or without a cellulose-based pre-coat) in order to sufficiently reduce suspended particles and protect the ion-exchange resin from damage. In some cases, no polishing filter is needed.

The ion-exchange chelating resin treatment is designed to decrease the sum of magnesium and calcium concentrations to < 20 $\mu\text{g/l}$. Table 2.4 indicates typical specifications required for

metals, sulphate and other impurities. These specifications can vary if the users want to operate at a low current density ($< 4 \text{ kA/m}^2$) or at a high current density. The specifications are more stringent for high current densities. Specifications also depend on the interaction of impurities. While the presence of one impurity may not be harmful, its synergistic combination with others may be (e.g. the combination of aluminium, calcium and silica). The resin is periodically regenerated with high-purity hydrochloric acid and sodium hydroxide solutions. Generally, one resin exchange column is in operation while another resin exchange column is regenerated.

Before the brine enters the membrane electrolysis cells, it is usually acidified with hydrochloric acid, which increases the lifetime of the anode coating and reduces the formation of oxygen, hypochlorite and chlorate. However, this increases the risk that precipitations of impurities such as iron and aluminium may occur inside the membrane rather than outside near the surface. Furthermore, over-acidification can reverse the hydrolysis of the carboxylate groups that provide high ion selectivity in the membrane, thereby irreversibly damaging them [10, Kirk-Othmer 2002], [34, Solvay 2010], [72, Nishio 2011].

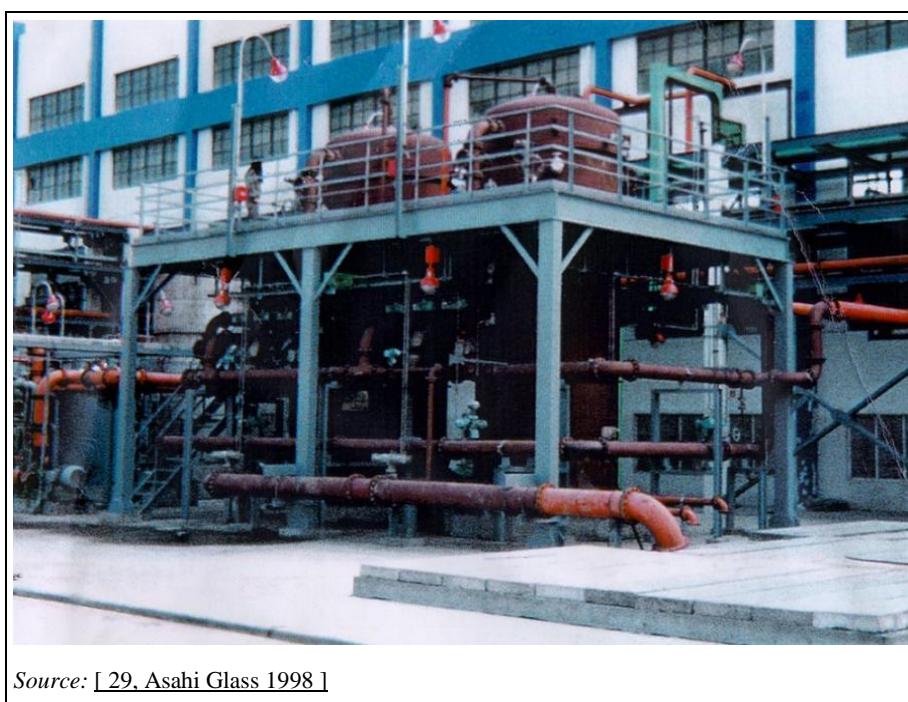

Figure 2.16: View of polishing filters in a secondary brine purification system

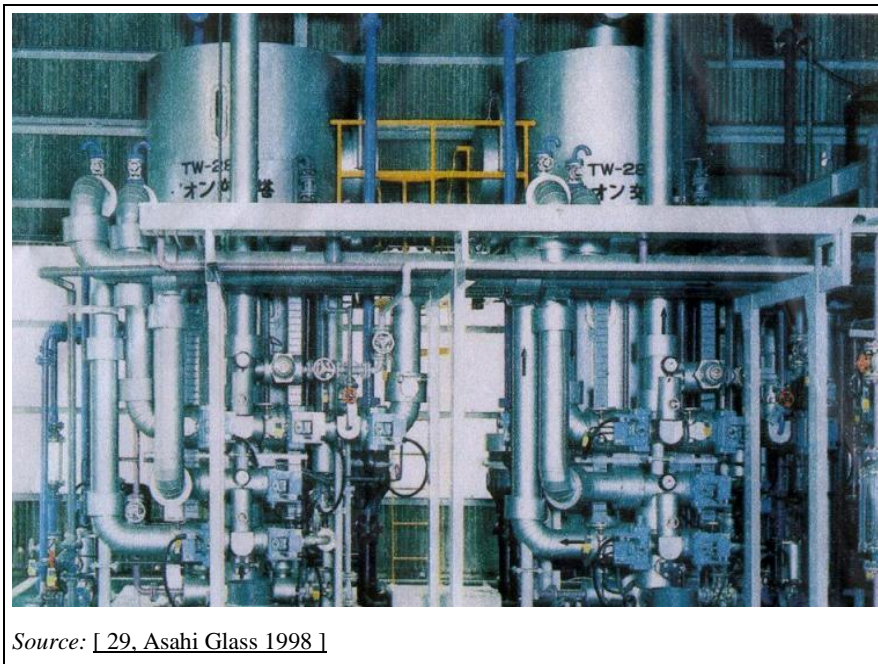

Figure 2.17: View of chelate resin towers in a secondary brine purification system

Table 2.4: Typical impurities with sources and effects on the membrane cell technique, as well as typical brine specifications

Impurity	Source	Typical upper limit of brine specification	Effects	Mechanism
$\text{Ca}^{2+} + \text{Mg}^{2+}$	Salt	20 ppb	Ca: CE Mg: V	Ca: Precipitation with various anions near the cathode side of the membrane, precipitation with silica and iodine in the membrane Mg: Fine precipitation with OH^- near the anode side of the membrane, precipitation with silica in the membrane
Sr^{2+}	Salt	0.1–4 ppm	CE, V	Precipitation with hydroxide on the cathode side of the membrane, precipitation with silica and iodine in the membrane
Ba^{2+}	Salt	0.05–0.5 ppm	CE, V	Very fine precipitation with iodine in the membrane, precipitation with silica in the membrane
Al^{3+}	Salt	0.1 ppm	CE, V	Precipitation with silica in the membrane, precipitation of calcium/strontium aluminosilicates near the cathode side of the membrane
Fe^{3+}	Salt, pipework, tank material, anti-caking agent	0.05–0.1 ppm ⁽¹⁾	V	Deposition on the cathode, precipitation with hydroxide on the anode side of the membrane or in the membrane (depending on pH of the brine)
Hg^{2+}	Parallel operation of mercury cell plant	0.2 ppm heavy metals	V	Deposition on the cathode
Ni^{2+}	Salt, pipework, tank material, cathode	0.2 ppm heavy metals	V	Deposition on the cathode, absorption in the membrane
ClO_3^-	Process side reactions	10 g/l (as NaClO_3)	O	Chlorination of the ion-exchange resin
I (e.g. $\text{H}_2\text{IO}_6^{3-}$)	Salt	0.1–0.2 ppm	CE, V	Very fine precipitation with calcium, strontium or barium in the membrane, precipitation with sodium on the cathode side of the membrane
F^-	Salt	0.5 ppm	V	Destruction of the anode coating
SO_4^{2-}	Salt, dechlorination with NaHSO_3	< 4–8 g/l (as Na_2SO_4)	CE	Precipitation with sodium near the cathode side of the membrane, anode coating with barium
SiO_2 (e.g. SiO_3^{2-})	Salt	10 ppm	CE	Silica itself is harmless, but in the presence of magnesium, calcium, strontium, barium or aluminium, silicates can be formed (see above)
Suspended solids	Salt	0.5–1 ppm	V	Precipitation on the anode side of the membrane
Total organic carbon	Salt	1–10 ppm	V	Increased foaming, overplating

⁽¹⁾ Higher iron concentrations could be permissible in cases of non-acidified feed brine.

NB: CE = current efficiency decreases; O = other effects; V = cell voltage increases.

Source: [1, Ullmann's 2006], [23, BASF 2010], [72, Nishio 2011], [136, Asahi Kasei 2008], [146, Arkema 2009]

2.5.3.4 Control of nitrogen compounds in the brine

The presence of some nitrogen compounds in the brine gives rise to the formation of nitrogen trichloride (NCl_3), which is an explosive substance. Techniques applied to reduce the concentration of nitrogen compounds in the brine are described in Section 2.6.11.4 together with other techniques to control NCl_3 .

2.5.4 Brine dechlorination and resaturation

Mercury and membrane cell plants usually operate with brine recirculation and resaturation (Figure 2.1). In 2011, there were, however, three plants operating on a once-through basis, one of them using the mercury cell technique, another one using the membrane cell technique and the third one using both the mercury and the membrane cell technique. The plants are located in Spain, Portugal and the United Kingdom, close to the sea and to large underground salt deposits (Table 8.1 in the Annex) [37, Euro Chlor 2010]. Diaphragm cell plants always use a once-through brine circuit, but some employ brine saturation using the salt recovered from the caustic evaporators.

In recirculation circuits, the depleted brine leaving the electrolyzers is first dechlorinated:

- only partially for the mercury cell technique (leaving active chlorine in the brine keeps the mercury in its oxidised form as HgCl_3^- and HgCl_4^{2-} and avoids the presence of metallic mercury in the brine purification sludge [3, Euro Chlor 2011]);
- totally for the membrane cell technique (necessary here because the active chlorine can damage the ion-exchange resins of the secondary brine purification unit).

For this purpose, the brine containing 0.4–1 g/l of dissolved chlorine is generally acidified to pH 2–2.5 and sent to an air-blown packed column or sprayed into a vacuum system of 50–60 kPa to extract the majority of the dissolved chlorine to a residual concentration of 10–30 mg/l. The chlorine-containing vapours are subsequently fed back to the raw chlorine collecting unit or directed to the chlorine absorption unit. The water that evaporates from the dechlorinated brine is condensed in a cooler. The condensate can be sent back to the brine system or chemically dechlorinated [1, Ullmann's 2006].

For the membrane cell technique, complete dechlorination is achieved by passing the brine through an activated carbon bed, by catalytic reduction, or by using chemical reducing agents such as sulphite (Section 4.3.6.3). Residual levels were reported to be < 0.5 mg/l or below the detection limit [3, Euro Chlor 2011] and < 0.1 mg/l [211, Dibble and White 1988].

No such dechlorination treatment is required for the diaphragm system, since any chlorine passing through the diaphragm reacts with caustic soda in the catholyte compartment to form hypochlorite or chlorate.

If the saturation is carried out with impure salt (followed by a primary purification step of the total brine flow), the pH of the dechlorinated brine is then brought to an alkaline value with caustic soda to reduce the solubilisation of impurities from the salt. If the saturation is carried out with pure salt (with subsequent primary purification on a small part of the flow), there is no alkalisation step prior to the resaturation (only in the purification phase).

Brine resaturation using solid salt is described in Section 2.5.2. In the case of mercury or membrane cell plants operating with solution-mined brine, brine resaturation is achieved by evaporation. During this step, sodium sulphate precipitates and can be recovered, purified and used for other purposes.

In the case of diaphragm cells, the catholyte liquor (10–12 wt-% NaOH, 15–17 wt-% NaCl) is directly used or transferred to the caustic evaporators, where solid salt and 50 wt-% caustic are

recovered together. Fresh brine may be saturated with recycled solid salt from the caustic evaporators before entering the diaphragm electrolyzers.

2.5.5 Chlorate destruction: membrane cell technique

In order to reduce the build-up of chlorate in the brine circuit, which could have negative effects on the ion-exchange resins (Table 2.4), the caustic quality, and on emissions to the environment, some membrane cell plants operate a chlorate destruction unit prior to the dechlorination (Figure 2.1). Techniques include the reduction of chlorate to chlorine with hydrochloric acid at temperatures higher than 85 °C and the catalytic reduction of chlorate to chloride with hydrogen (Section 4.3.6.4).

2.6 Chlorine processing, storage and handling

2.6.1 General description

Generally, before the chlorine can be used, it goes through a series of processes for cooling, cleaning, drying, compression and liquefaction. In some applications, it can be used as a dry gas without the need for liquefaction. Very occasionally it can be used directly from the electrolyzers. A general flow of chlorine from the electrolyzers to storage is presented in Figure 2.1. The chlorine process usually takes hot, wet cell gas and converts it to a cold, dry gas. Chlorine gas leaving the electrolyzers has a temperature of approximately 80–90 °C and is saturated with water vapour. It also contains brine mist, impurities such as N₂, H₂, O₂, CO₂ and traces of chlorinated hydrocarbons. Electrolyzers are operated at essentially atmospheric pressure with only a few mbar difference between the pressure of the anolyte and the catholyte.

2.6.2 Materials

The strong oxidising nature of chlorine requires a careful choice of construction materials at all stages of processing, depending on the operating conditions (temperature, pressure, state of matter, moisture content). Most metals are resistant to dry chlorine at temperatures below 100 °C. Above a specific temperature for each metal, depending also on the particle size of the metal, spontaneous ignition takes place (150–250 °C for iron). Carbon steel is the material most commonly used for dry chlorine gas (water content below 20 ppmw). Wet chlorine gas rapidly attacks most common metallic materials with the exception of tantalum and titanium, the latter being the preferred choice in chlor-alkali plants. However, if the system does not remain sufficiently wet, titanium ignites spontaneously (ignition temperature ~ 20 °C). Other construction materials such as alloys, graphite, glass, porcelain and polymers may be used, depending on the conditions. Oils or greases generally react with chlorine upon contact, unless they are fully halogenated [1, Ullmann's 2006], [3, Euro Chlor 2011].

2.6.3 Cooling

In the primary cooling process, the total volume of gas to be handled is reduced and a large amount of moisture is condensed. Cooling is accomplished in one or several stages with water, brine or other fluids. Care is taken to avoid excessive cooling because, at around 10 °C, chlorine can combine with water to form a solid material known as chlorine hydrate (Cl₂ · n H₂O; n = 7–8). Maintaining temperatures above 15 °C prevents blockages in the process equipment [1, Ullmann's 2006], [54, Euro Chlor 2010], [117, Euro Chlor and Spolchemie 2012].

Two methods are most frequently used to cool chlorine gas [38, O'Brien and White 1995], [117, Euro Chlor and Spolchemie 2012].

- One method is indirect cooling through a titanium surface (usually in a single-pass vertical shell-and-tube heat exchanger). The resultant condensate is either fed back into the brine system of the mercury or membrane cell technique or is dechlorinated by evaporation in the case of the diaphragm cell technique. This method causes less chlorine to be condensed or absorbed and generates less chlorine-saturated water for disposal. Indirect cooling can be carried out in once-through, open-recirculating, or closed-loop systems.
- Another method is direct cooling with water (or brine or other fluids). The chlorine gas is cooled by passing it directly into the bottom of a tower. Water is sprayed from the top and flows countercurrently to the chlorine. The cooling water is generally free of traces of ammonium salts, to avoid the formation of nitrogen trichloride. This method has the

advantage of better mass transfer characteristics and higher thermal efficiencies. Direct cooling is usually carried out in closed-loop systems.

2.6.4 Cleaning of wet chlorine

Following primary cooling, water droplets and impurities such as brine mist are removed mechanically by using special filters with glass wool fillings or porous quartz granules, or by means of an electrostatic precipitator. Chlorine is then passed to the drying towers [1, Ullmann's 2006].

2.6.5 Drying

Chlorine from the cooling system is more or less saturated with water vapour. The water content is typically 1–3 vol-%. This must be reduced in order to avoid downstream corrosion and to minimise the formation of hydrates [38, O'Brien and White 1995].

The drying of chlorine is carried out almost exclusively with concentrated sulphuric acid (96–98 wt-%) in countercurrent contact towers in two to six stages, which reduce the moisture content to less than 20 mg/m³ [54, Euro Chlor 2010]. The remaining moisture content depends on the temperature and concentration of the sulphuric acid in the last drying stage. For low-temperature liquefaction (Section 2.6.8), a lower moisture content is required, which can be achieved by adding more equilibrium stages to the drying towers or by using molecular sieves to levels of 3–9 mg/m³ [3, Euro Chlor 2011], [54, Euro Chlor 2010].

The number of stages is usually increased to lower the final strength of the spent sulphuric acid. For example, three stages are needed to reach a spent acid concentration of 50–65 wt-% while six stages are needed for a final concentration of 30–40 wt-%. The columns contain plastic packing resistant to chlorine and sulphuric acid to improve fluids distribution, increase efficiency and lower pressure drops, and thus reduce energy consumption. The heat liberated during dilution of the circulating acid is removed by titanium heat exchangers, and the spent acid is dechlorinated chemically or by stripping. The concentration of the spent acid depends on the number of drying stages and the further potential use or method of disposal. In some cases, the acid is reconcentrated to 96 wt-% by heating it under vacuum and then it is subsequently recirculated. Sometimes the acid is sold or used for other purposes. Rarely, it becomes waste [3, Euro Chlor 2011], [54, Euro Chlor 2010].

2.6.6 Cleaning of dry chlorine

When leaving the top of the drying tower, dry chlorine passes through high efficiency demisters or a packed bed to prevent the entrainment of sulphuric acid droplets.

Further potential cleaning steps after chlorine drying include [1, Ullmann's 2006], [3, Euro Chlor 2011], [54, Euro Chlor 2010], [56, Euro Chlor 2008]:

- adsorption on carbon beds to remove organic impurities;
- absorption-desorption using a suitable solvent such as carbon tetrachloride to remove nitrogen trichloride and organic impurities;
- scrubbing with concentrated hydrochloric acid to remove nitrogen trichloride;
- scrubbing with liquid chlorine to remove nitrogen trichloride, organic impurities, carbon dioxide and bromine;
- irradiation with UV to destroy nitrogen trichloride and hydrogen.

2.6.7 Compression

After drying and potential further cleaning, chlorine gas may be compressed by a variety of compressors, depending on the throughput and the desired pressure [1, Ullmann's 2006], [3, Euro Chlor 2011]:

Rotary compressors, such as:

- sulphuric acid liquid ring compressors for throughputs of 150 t/d per compressor and for pressures of 4 bar or, in two-stage compressors, 12 bar;
- screw compressors for low throughputs and for pressures of up to 16 bar.

Reciprocating compressors, such as:

- dry ring compressors for throughputs of 200 t/d per compressor and for pressures of up to 16 bar.

Centrifugal compressors, such as:

- turbo compressors in mono- or multi-stage operation for throughputs of up to ~ 1 800 t/d per unit and for pressures of up to 16 bar;
- sundyne blowers for throughputs of 80–250 t/d per compressor and for pressures of up to 3 bar.

Because of heat build-up from compression, multi-stage units with coolers between stages are usually necessary. Compressor seals are generally fitted with a pressurised purge to inhibit the leakage of chlorine to the atmosphere [39, HMSO 1993]. Dry chlorine at high temperatures can react spontaneously and uncontrollably with iron. Chlorine temperatures are therefore usually kept below 120 °C (Section 2.6.2) [56, Euro Chlor 2008].

2.6.8 Liquefaction

Liquefaction can be accomplished at different pressure and temperature levels: at ambient temperature and high pressure (for example 18 °C and 7–12 bar), at low temperature and low pressure (for example -35 °C and 1 bar) or any other intermediate combination of temperature and pressure. Important factors for selecting appropriate liquefaction conditions include the composition of the chlorine gas, the desired purity of the liquid chlorine and the desired yield. Increasing the liquefaction pressure increases the energy consumption of compression, although the necessary energy for cooling decreases, resulting in an overall reduction in energy consumption.

The liquefaction yield is typically limited to 90–95 % in a single-stage installation, as hydrogen is concentrated in the residual gas and its concentration needs to be kept below the lower explosive limit (Section 2.6.11.3).

Higher yields of up to 99.8 % can be achieved by multi-stage liquefaction. Typically, small volume liquefiers which are protected against explosions are used after primary liquefaction, and inert gas is added to keep the mixture below the lower explosive limit [1, Ullmann's 2006]. Another possibility is to remove hydrogen from the system by reaction with chlorine gas in a column, yielding hydrogen chloride which can be recovered in a hydrochloric acid unit. The remaining chlorine gas can then be safely further condensed. This solution can be chosen if hydrochloric acid is a saleable product or if it can be used as a feedstock for downstream production, such as for ferric chloride.

The choice of the refrigerant in a certain stage of the liquefaction depends on the pressure of the chlorine. When the pressure is sufficiently high, water can be used as an indirect refrigerant.

When the pressure is relatively low, other refrigerants such as hydrochlorofluorocarbons (HCFCs) or hydrofluorocarbons (HFCs), typically chlorodifluoromethane (HCFC-22) and 1,1,1,2-tetrafluoroethane (HFC-134a) (indirect cooling), ammonia (indirect cooling) or liquid chlorine (direct cooling) are used.

The use of HCFCs such as HCFC-22 is generally prohibited but reclaimed or recycled HCFCs may be used for the maintenance or servicing of existing refrigeration equipment until 31 December 2014 [78, Regulation EC/1005/2009 2009].

In the two surveys carried out in 2010 and 2012 (Section 3.1), 24 plants in the EU-27 provided information on the refrigerants that were used for liquefaction in the period between 2008 and 2011. Eight plants used HCFC-22, seven plants HFC-134A, five plants R-507A, three plants ammonia and two plants carbon dioxide. For chlorine, water, R-410A and R-422A, there was in each case one plant using them as a refrigerant. Several of the plants used a combination of refrigerants for chlorine liquefaction [57, CAK TWG 2012].

The temperature of the chlorine gas in a certain stage depends mainly on the pressure after compression. A pressure > 8 bar generally enables water cooling, but implies an increased hazard [3, Euro Chlor 2011].

Table 2.5 shows the possible trade-offs between the different types of chlorine gas liquefaction systems and refrigerants used.

Table 2.5: Trade-offs in chlorine gas liquefaction

Liquefaction system	Refrigerant	Safety aspect	Costs ⁽¹⁾
High pressure (7–16 bar) and high temperatures (~ 40 °C)	Water	High precautions	Low energy costs
Medium pressure (2–6 bar) and medium temperatures (between -10 °C and -20 °C)	Water, HCFC/HFC or ammonia	Moderate precautions	Moderate energy costs
Normal pressure (~ 1 bar) and low temperatures (below -40 °C)	Mainly HCFC/HFC or ammonia	Precautions ⁽²⁾	High energy costs
⁽¹⁾ Globally, the costs for equipment are comparable. ⁽²⁾ The solubility of other gases increases at low temperatures, especially that of carbon dioxide. <i>Source:</i> [1, Ullmann's 2006], [3, Euro Chlor 2011], [17, Dutch Ministry 1998]			

The residual chlorine in the tail gas can be used to produce hypochlorite, iron(III) chloride or hydrochloric acid. The residual chlorine which cannot be valorised is then led to the chlorine absorption unit (Section 2.6.12). In some cases, it is recovered by an absorption-desorption process with carbon tetrachloride [36, Euro Chlor 2010]. The latter has the disadvantage of using a toxic substance with a high ozone depletion and global warming potential.

2.6.9 Handling and storage

Liquefied chlorine is stored at ambient or low temperature. The pressure corresponds to the vapour pressure of the liquefied chlorine at the temperature in the storage tank. Pressure storage at ambient temperatures (~ 7 bar at 20 °C) has advantages of simplicity of operation, ease of visual external inspections, as well as lower energy and investment costs. Low-pressure storage operating around the boiling point of liquid chlorine (-34 °C) requires more complex infrastructure, particular safety measures and higher energy costs [1, Ullmann's 2006], [40, Euro Chlor 2002], [41, Euro Chlor 2002].

Within a plant and over distances of several kilometres, chlorine can be transported by pipelines, either as a gas or a liquid. The liquid chlorine from the bulk tank can be used as a feedstock for on-site processes or loaded into containers, or road or rail tankers.

2.6.10 Vaporisation

Liquid chlorine is usually vaporised prior to use. The easiest option is to use ambient heat by which approximately 5 kg of chlorine per hour and square metre of container surface can be vaporised. For higher flowrates, it is necessary to use a chlorine vaporiser [56, Euro Chlor 2008].

2.6.11 Dealing with impurities

2.6.11.1 Overview

Chlorine gas from the electrolysis cells may contain impurities such as water, nitrogen trichloride (NCl_3), bromine (Br_2), halogenated hydrocarbons ($\text{C}_x\text{H}_y\text{X}_z$) originating from rubberised or plastic piping, carbon dioxide (CO_2), oxygen (O_2), nitrogen (N_2) and hydrogen (H_2).

Nitrogen trichloride, bromine and halogenated hydrocarbons predominantly dissolve in the liquid chlorine, whereas the non-condensable gases (CO_2 , O_2 , N_2 , H_2) remain in the gas phase and increase in concentration during chlorine liquefaction. Traces of sulphuric acid, ferric sulphate, and/or ferric chloride might also be present in the liquid phase after drying and liquefaction of chlorine.

Liquid chlorine of commercial quality has a purity of at least 99.5 wt-% with the following specifications: water: < 0.005 wt-%, solid residues: < 0.02 wt-%, CO_2 : \leq 0.5 wt-%, N_2 : 0.1–0.2 wt-% and O_2 : 0.1–0.2 wt-% [1, Ullmann's 2006].

The impurities described in the following subsections are of particular concern.

2.6.11.2 Water

The presence or absence of water considerably alters the reactivity of chlorine towards the equipment material (Section 2.6.2).

2.6.11.3 Hydrogen

All three cell techniques produce hydrogen, which can form an explosive mixture with chlorine or air. Light, friction and gas depressurisation may create enough energy to initiate the reaction at ambient temperature. The lower explosive limit of hydrogen in pure chlorine depends on temperature and very minimally on pressure, and equates to approximately 4 vol-% H_2 at ambient temperatures. Most plants therefore keep the hydrogen concentration below 4 vol-%, either by adding inert gases such as nitrogen or carbon dioxide or by reacting the hydrogen to hydrochloric acid (Section 2.6.8) [1, Ullmann's 2006], [10, Kirk-Othmer 2002]. The concentration of hydrogen in chlorine is usually measured continuously to ensure the absence of an explosive mixture [3, Euro Chlor 2011].

2.6.11.4 Nitrogen trichloride

Nitrogen trichloride (NCl_3) is formed during the electrolytic production of chlorine, due to side reactions in the brine between the chlorine and some nitrogen compounds originating from the raw materials (mainly ammonium and organic nitrogen compounds). Molecular nitrogen and nitrates do not react with chlorine. Nitrogen may originate from [201, Piersma 2001]:

- salt: explosives used in rock salt mining, anti-caking agents (ferrocyanide), impurities from transport vehicles;
- water (used for brine preparation or direct cooling): ammonia in distilled water or steam condensate, ammonium (from fertilisers) and humic acids in surface water or groundwater;
- ancillary materials: caustic soda which was purified by using liquid ammonia; sulphuric acid contaminated with ammonium.

Nitrogen trichloride is characterised by its very high instability. Experimental results show that chemical decomposition of NCl_3 in liquid chlorine at concentrations > 3 wt-% is rapid and strongly exothermic [35, Euro Chlor 2012].

NCl_3 has a higher boiling point (71°C) than chlorine (-34°C) and any NCl_3 present in the chlorine gas thus concentrates in the liquid phase in a chlorine liquefaction process. An NH_3 concentration of 1 mg/kg in the feed brine typically leads to NCl_3 concentrations of 37–56 mg/kg in liquid chlorine. Any evaporative handling of liquid chlorine in subsequent processes is potentially dangerous due to the further selective concentration of NCl_3 in the liquid phase [35, Euro Chlor 2012].

The formation of NCl_3 can be reduced by appropriate selection and control of the raw materials, by stripping ammonia with air under alkaline conditions, or by the chlorination of ammonia to monochloramine or molecular nitrogen at a pH higher than 8.5. Methods to remove NCl_3 from chlorine after it is formed include its destruction using, for example, ultraviolet radiation or activated carbon, as well as extraction with carbon tetrachloride (Section 4.3.5.3) [36, Euro Chlor 2010].

2.6.11.5 Bromine

The quantity of bromine present depends on the quality of the salt used. Its concentration is generally higher if chlorine is obtained by electrolysis of potassium chloride to obtain potassium hydroxide (Section 2.9). Bromine, like water, can accelerate the corrosion of the materials.

In addition to the reduction of the bromide (Br^-) levels via the raw material specifications, bromide can be removed from the brine by the oxidation and stripping of bromine, which is then absorbed in a caustic solution. Another technique is to distil the liquefied chlorine to enrich the heavy end with bromine, which can then be further extracted for sale or the mixture can be destroyed [42, Euro Chlor 2010].

2.6.12 The chlorine absorption unit

2.6.12.1 Purpose

Every chlor-alkali plant generates waste gases consisting of N_2 , O_2 , H_2 , CO_2 and 1–8 % of the original chlorine produced. Although the quality of these waste gases is usually insufficient for the main chlorine uses, the chlorine therein still represents a certain market value and is often used for the synthesis of bleach (sodium hypochlorite), hydrochloric acid, iron trichloride, chlorinated hydrocarbons or sulphur monochloride. Most common is the production of bleach in a chlorine absorption unit. Irrespective of the use of the residual chlorine, the absorption of

chlorine in caustic solution usually represents the last step before waste gas is released to the atmosphere (Figure 2.18) [17, Dutch Ministry 1998].



Figure 2.18: View of a chlorine absorption unit

The purpose of a typical chlorine absorption system is twofold:

- To continuously absorb chlorine gas arising in streams such as tail gas from liquefaction, air blown from the dechlorination of waste brine or chlorine condensate, or from wet and dry maintenance headers. Up to 5 % but normally less than 1 % of the plant production is absorbed in this way.
- To absorb the full cell room production during an emergency for an adequate period to enable corrective measures to be taken or the plant to be shut down in a safe manner. Gravity-fed head tanks or pumps supplied with backup power supplies may be used to give increased reliability and operation under power failure conditions.

The aforementioned purposes can be achieved by using one or several systems, usually composed of several absorption units placed in series or in parallel to ensure a high level of availability by redundancy. Some additional equipment is often installed as a backup. Packed towers and/or ejector systems are usually used in the chlorine absorption unit (Section 4.3.5.1) [3, Euro Chlor 2011].

2.6.12.2 Chemical reactions

All waste gases contaminated or potentially contaminated with chlorine pass into the atmosphere through a wet scrubber usually containing caustic soda. This leads to the formation of sodium hypochlorite:



Two major side reactions may lead to the decomposition of hypochlorite in the scrubber. The first reaction is a disproportionation to chlorate and chloride with an intermediate formation of chlorite [190, Czarnetzki and Janssen 1992], [192, Euro Chlor 2011], [195, Bolyard et al. 1992]:

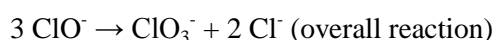
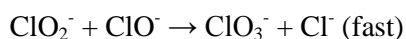
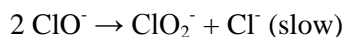

The second reaction is a disproportionation to oxygen and chloride [192, Euro Chlor 2011]:

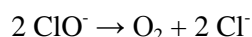

All three reactions, the scrubber reaction and the two disproportionation reactions, produce considerable heat. In addition, the decomposition reactions of hypochlorite are accelerated by lower pH values, the presence of metal ions and by higher temperatures. The decomposition reactions are therefore self-accelerating [192, Euro Chlor 2011].

If chlorine continues to be fed to the absorption unit after all caustic soda has been consumed, it will dissolve until the solution is saturated and then it will be emitted to the atmosphere. Additionally, the disproportionation of chlorine and other side reactions lead to lower pH values, which result in lower chlorine saturation concentrations and thus increased emissions of chlorine [192, Euro Chlor 2011]:

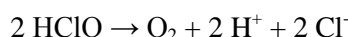
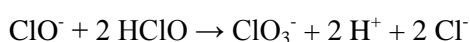

The pH, however, does not drop below a value of 4.7 even if more chlorine is fed to the absorption unit [192, Euro Chlor 2011].

Another process consideration is the formation of salts with limited solubility in the scrubbing solution, which may lead to a blockage of equipment. This concerns sodium chloride, which is formed during the scrubbing and decomposition reactions, as well as sodium carbonate which originates from carbon dioxide impurities [192, Euro Chlor 2011]:

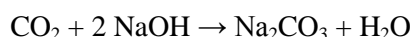

The solubility of sodium carbonate in scrubbing solution is low. Lowering the pH value leads to the gradual conversion of sodium carbonate to sodium hydrogen carbonate, the solubility of which is very low in the scrubbing solution. Therefore, solid salts may precipitate when carbon dioxide is present in chlorine or when the caustic soda comes into contact with the atmosphere, especially if the caustic is depleted so that the pH value drops below 12 [192, Euro Chlor 2011].

2.6.12.3 Use and treatment of the produced bleach

The bleach (solution of sodium hypochlorite) produced by the chlorine absorption unit usually has too low a concentration of active chlorine to be sold, but can be used to feed the commercial hypochlorite production unit. In some cases, this diluted bleach can be used directly on the site (e.g. for the treatment of cooling water, Section 4.3.6.3.7) or can be recycled to the brine system (Section 4.3.6.3.6). If this is not possible, the bleach has to be destroyed. This can be achieved by chemical reduction to chloride using agents such as sulphite, by thermal decomposition to oxygen and chloride with or without a catalyst, by thermal decomposition to chlorate and chloride at increased temperatures, as well as by acidic decomposition with the release and recovery of the chlorine (Section 4.3.6.3) [3, Euro Chlor 2011], [192, Euro Chlor 2011].

2.7 Caustic processing, storage and handling

Figure 2.19 shows an example of a caustic processing and storage system.

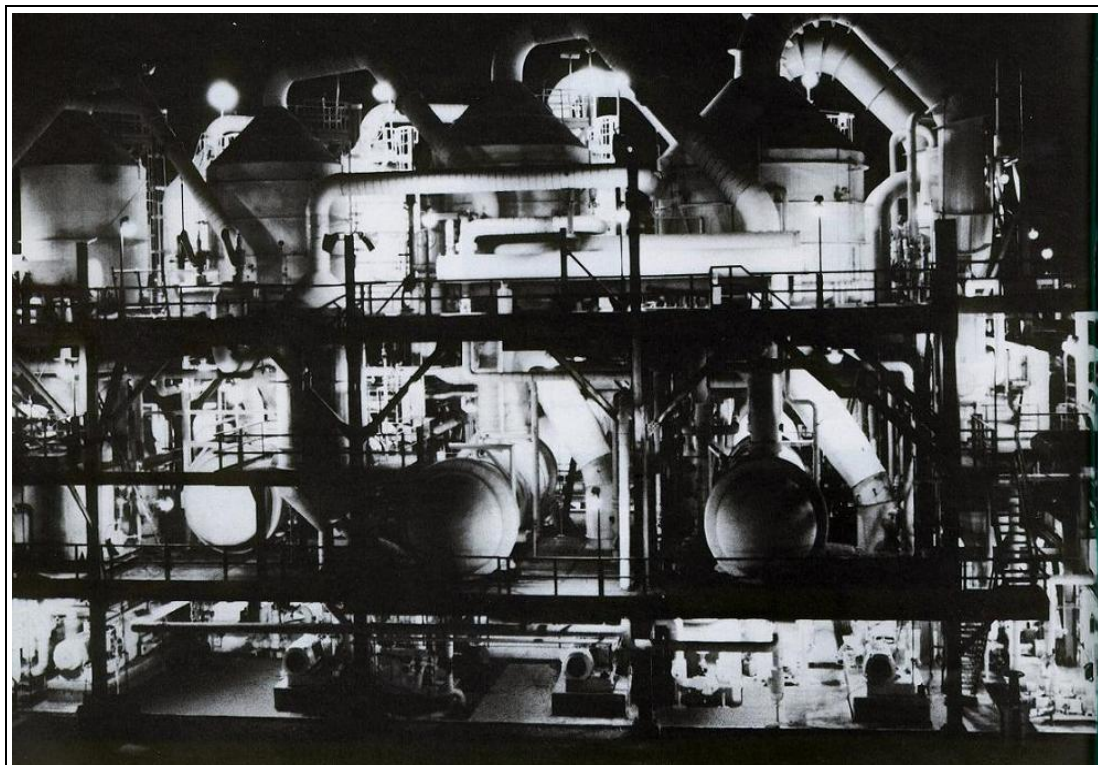

Source: [44, OxyChem 1992]

Figure 2.19: View of caustic production and storage

The caustic soda solution from the three techniques is treated in slightly different ways due to the difference in composition and concentration (Figure 2.1).

In the case of the mercury cell technique, 50 wt-% caustic soda is obtained directly from the decomposers. The caustic soda is normally pumped through a cooler, then through a mercury removal system and then to the intermediate and final storage sections. In some cases, the caustic is heated before filtration. The most common method for the removal of mercury from caustic soda is a plate (or leaf) filter with a carbon pre-coat. Under normal operating conditions, mercury cell caustic soda (as 100 % NaOH) contains 20–100 ppmw of sodium chloride and 40–60 $\mu\text{g Hg/kg NaOH}$ [17, Dutch Ministry 1998], [45, Euro Chlor 1997].

In the case of the diaphragm and membrane cell techniques, the caustic soda is usually concentrated to 50 wt-% by evaporation before storage. Steam is used as the source of evaporative energy.

In the case of the diaphragm cell technique, this is achieved by triple- or quadruple-effect evaporators. Increasing the number of effects reduces energy consumption and operating costs but increases investment costs. The presence of salt in the diaphragm cell liquor requires that the evaporator be equipped with scraper blades or other devices to draw off the precipitated salt, which is then usually reused for brine preparation (Section 2.3.1). Sodium sulphate present in the cell liquor (0.12–0.65 wt-%) also crystallises in the later stages of evaporation and may be isolated to avoid contamination of the main portion of the recovered salt. The residual level of sodium chloride in sodium hydroxide from diaphragm cells is approximately 1 wt-% and sodium chlorate approximately 0.1 wt-%. For this reason, it is unsuitable for certain end

applications such as the manufacture of rayon. The concentrations of salt and sodium chlorate in the caustic soda from diaphragm cells can be reduced by extraction with anhydrous liquid ammonia to increase marketability, but at an increased cost [1, Ullmann's 2006], [17, Dutch Ministry 1998].

In the case of the membrane cell technique, concentration of the caustic soda is normally achieved in two or three stages using either plate or shell-and-tube evaporators. The number of stages depends on factors such as plant size and the cost of steam. The caustic soda from membrane cells is of high quality, although the caustic soda produced (usually around 32 wt-% NaOH) needs to be concentrated to 50 wt-% NaOH to be traded as a commodity. The NaCl content of the membrane-cell caustic soda lies between 20 and 100 ppmw (in 100 % NaOH), but is on average slightly higher than mercury cell caustic [1, Ullmann's 2006], [3, Euro Chlor 2011], [17, Dutch Ministry 1998].

In some plants, the caustic soda is further concentrated to a 73 wt-% solution and to solid caustic prills or flakes with a water content of < 0.5–1.5 wt-%, using multi-effect evaporators.

Some chlor-alkali production facilities combine the caustic production process from mercury and membrane cells in order to minimise energy costs (Figure 2.8).

Because of its highly reactive and corrosive properties, caustic soda may corrode containers and handling equipment. Construction materials must be suited to the caustic soda handled and stored.

Caustic solutions require steam or electrical heating where temperatures can fall below the freezing point. Depending on the concentration, the freezing point can be higher than 0 °C; for example it is 5 °C for 32 wt-% NaOH and 12 °C for 50 wt-% NaOH. Frozen pipelines present both safety and environmental risks when attempts are made to unblock them [3, Euro Chlor 2011].

Storage tanks may be lined in order to minimise iron contamination of the product or to prevent stress corrosion cracking of the tank. Tanks are usually included in procedures to prevent overflow or spillage of caustic soda. Such procedures include containment and mitigation.

Dissolved hydrogen gas can be released into the vapour space above the liquid in storage tanks. Tanks are normally vented from the highest point. Testing for an explosive mixture of hydrogen and air normally precedes any maintenance activity in the area.

2.8 Hydrogen processing, storage and handling

Hydrogen leaving the cells is highly concentrated (> 99.9 vol-%) and normally cooled to remove water vapour, sodium hydroxide and salt (Figure 2.1). The solution of condensed salt water and sodium hydroxide is recycled to produce caustic, as brine make-up or is treated with other waste water streams [3, Euro Chlor 2011].

In the case of the membrane or diaphragm cell technique, the cooling is usually carried out by one or more large heat exchangers. In the mercury cell technique, primary cooling is carried out at the electrolyser, allowing mercury vapour to condense into the main mercury circuit. Further cooling and mercury removal takes place at a later stage using a variety of techniques (Section 3.5.6.3.4) [1, Ullmann's 2006], [87, Euro Chlor 2006].

Some uses of hydrogen require additional removal of traces of oxygen, which may be achieved by reacting the oxygen with some of the hydrogen over a platinum catalyst [10, Kirk-Othmer 2002].

Hydrogen may be distributed to users using booster fans or fed to the main compression plant, which usually comprises a number of compressors and a gas holder (surge chamber). The hydrogen gas holder is incorporated into the system to minimise fluctuations in gas pressure from the primary stage. The hydrogen product gas stream is always kept pressurised to avoid the ingress of air. All electrical equipment taken into the hydrogen compression plant area must be 'intrinsically safe' (i.e. the equipment will not produce a spark) or explosion proof (i.e. a local small explosion is contained within the equipment). A relief valve is normally provided within the system to relieve high pressure to atmosphere. Hydrogen is normally monitored for oxygen content, and the compression will shut down automatically in critical situations [3, Euro Chlor 2011], [45, Euro Chlor 1997].

The hydrogen sold to distributors is usually compressed at pressures higher than 100 bar and is injected into a pipeline network. Otherwise, the hydrogen is transported in dedicated tank lorries or in steel bottles at pressures of up to 300 bar. For these high pressures, the gas is further dried and traces of oxygen are usually removed [30, Euro Chlor 2010].

The main utilisations of the co-produced hydrogen are combustion to produce steam (and some electricity) and chemical reactions such as the production of ammonia, hydrogen peroxide, hydrochloric acid and methanol [16, Agência Portuguesa do Ambiente 2010], [30, Euro Chlor 2010].

2.9 Production of caustic potash

Potassium chloride is used as a raw material for the production of potassium hydroxide. It occurs naturally, mostly as sylvinite, and can be purified by crystallisation from solution, flotation or electrostatic separation [43, Spolchemie 2010]. Typical compositions of potassium chloride used in chlor-alkali electrolysis are shown in Table 2.6.

Table 2.6: Typical compositions of potassium chloride used in chlor-alkali electrolysis

Component	Salt used by/from	
	Spolchemie	K&S Kali GmbH
KCl	98.5–99.5 %	99.1 %
Na ⁺	0.2–0.6 %	0.3 %
H ₂ O	< 0.2 %	0.1 %
SO ₄ ²⁻	< 0.1 %	0.03 %
Br ⁻	0.04–0.1 %	0.2 %
Ca ²⁺	NI	0.006 %
Mg ²⁺	NI	0.006 %
NB: NI = no information provided.		
<i>Source:</i> [43, Spolchemie 2010], [292, K+S Kali GmbH 2012]		

The electrolysis of potassium chloride brine to produce caustic potash differs in some aspects from the much more common electrolysis of sodium chloride brine. For example, the bromide content of raw KCl salt is ~ 0.2 % compared to only ~ 0.002 % in NaCl (Table 2.6). The resulting higher concentration of bromine in the produced chlorine gas causes difficulties such as higher corrosion rates, as well as the necessity to use more sophisticated equipment and more energy for chlorine purification (Sections 2.6.6 and 2.6.11.5) [42, Euro Chlor 2010].

Another difference is that the mercury cell technique based on KCl is much more sensitive to trace quantities of metals such as vanadium and molybdenum in the brine, as well as to sodium in the amalgam; both types of catalysts potentially causing increased hydrogen evolutions in the cell (Section 2.2.1). Therefore, a higher brine purity is required, which can be achieved by setting stricter raw material specifications and/or a two-step filtration, along with more frequent cell openings for maintenance and cleaning. NaCl present in the brine is converted to NaOH during electrolysis and amalgam decomposition and is transferred to KOH [1, Ullmann's 2006], [42, Euro Chlor 2010].

In membrane cell plants, the KOH units now use the same membrane as the NaOH units; until recently, membranes with different electrochemical characteristics were used. The concentration of chlorides and chlorates in KOH from membrane cells is higher (typically ~ 20 mg KCl/kg of 50 wt-% KOH) compared to KOH from mercury cells (< 3 mg KCl/kg of 50 wt-% KOH) [42, Euro Chlor 2010].

Table 2.7 shows caustic potash specifications from different suppliers.

Table 2.7: Caustic potash specifications from different suppliers

Supplier	Concentration				Cell technique
	KOH	KCl	KClO ₃	Hg	
	wt-%	mg/kg	mg/kg	mg/kg	
Evonik Industries	44.7–45.3	≤ 6	NI	< 0.10	Mercury cell technique
	49.7–50.3	≤ 6	NI	< 0.10	
Kanto Chemical	≥ 86.0	≤ 42	NI	NA	Membrane cell technique
Oxychem	45.0–46.0	≤ 50	≤ 30	NA	
	50.0–51.0	≤ 50	≤ 30	NA	
Taixing Xiangyun Chemical	48.0	≤ 41	NI	NA	

NB: NA = not applicable; NI = no information provided.
Source: [288, Evonik 2011], [289, OxyChem 2008], [290, Taixing Xiangyun Chemical 2011], [291, Kanto Chemical 2011]

The migration of chloride through the membrane is driven by the concentration gradient against the electric potential, and is independent of the current density. However, the caustic production rate increases with increasing current densities. Because of this, the concentration of chloride in the caustic decreases with increasing current densities. At a current density of 6 kA/m², the chloride concentration in caustic soda and caustic potash is similar, while at current densities of 1.5 kA/m², the chloride concentration in caustic soda is considerably higher than in caustic potash [42, Euro Chlor 2010].

Plants producing both NaOH and KOH keep the brine circuit completely separated even if the electrolytic cells are in the same cell room. The switching of cells or of groups of cells from one production to the other is possible but is usually avoided because it requires a time-consuming cleaning process and the caustic solution does not meet the normal quality specifications for a couple of hours after the restart [42, Euro Chlor 2010].

3 CURRENT EMISSION AND CONSUMPTION LEVELS

3.1 Introduction

In this chapter, the quantitative consumption and emission levels are given for the three cell techniques (mercury, diaphragm, membrane). Furthermore, the chapter contains some information on historically contaminated sites.

The figures reported in this chapter are mostly based on two surveys at the individual installation level, carried out by the TWG in the first quarter of 2010 and the second quarter of 2012, to a large extent coordinated by Euro Chlor. The first survey aimed to provide general information on the sector, while the second aimed to validate and correct the data provided during the first survey, as well as to gather more specific additional data. The TWG, and in particular the EIPPCB, peer-reviewed the submitted questionnaires to ensure that data were of good quality, and on numerous occasions contacted individual installations to request further clarifications. The information from the individual questionnaires was subsequently compiled and analysed.

66 chlor-alkali plants participated in the first survey in 2010 and 43 installations in the second in 2012. 25 installations participated only in the first survey, 2 installations only in the second and 41 installations in both. The survey did not cover the four installations that produce chlorine from molten salt or from hydrochloric acid, since these are outside the scope of this document. For the first survey, 86 % of the chlor-alkali plants in operation at that time participated, representing 96 % of the installed chlorine production capacities. For the second survey, the coverage was 58 % in terms of number of chlor-alkali plants and 59 % in terms of capacities. During the first survey, approximately 60 % of the installations reported data for the reference year 2008 and approximately 40 % for 2009, while during the second survey 19 % of the installations reported data for 2008, 19 % for 2009, 16 % for 2010 and 47 % for 2011 [57, CAK TWG 2012].

In contrast to the process described in the previous paragraph, energy consumption data were submitted to the statistical department of CEFIC because of their confidential nature. Aggregated figures were then forwarded to Euro Chlor and then provided to the TWG [58, Euro Chlor 2010].

Other figures were taken from the original BREF [75, COM 2001] and from the literature, as indicated.

Unless otherwise stated, consumption and emission data shown in this chapter refer to normal operating conditions. Moreover, concentrations in gases refer to standard conditions, i.e. a temperature of 273.15 K and a pressure of 101.3 kPa, after deduction of the water content but without correction of the oxygen content.

In the surveys, some plants reported emission and consumption values as ranges with minimum and maximum values, while others provided annual average values. Some plants reported both. Ranges and averages were treated as statistically independent from each other. The tables in this chapter typically show statistical minimum, median and maximum values, as well as percentiles of the aforementioned ranges (minimum/maximum) and annual averages (Table 3.1).

Table 3.1: Example table explaining how emission and consumption data are typically displayed in the tables of this chapter

Value reported	Explanation				
	Min.	25th percentile	Median	75th percentile	Max.
Min.	Lowest minimum value reported	25th percentile of reported minimum values	Median of reported minimum values	75th percentile of reported minimum values	Highest minimum value reported
Max.	Lowest maximum value reported	25th percentile of reported maximum values	Median of reported maximum values	75th percentile of reported maximum values	Highest maximum value reported
Average	Lowest average value reported	25th percentile of reported average values	Median of reported average values	75th percentile of reported average values	Highest average value reported

3.2 Overview of emission and consumption levels of all cell plants

Emission and consumption levels of the chlor-alkali industry are quite specific to the cell technique used but also depend on the specifications of the products (O_2 or CO_2 content, for example), the purity of the incoming salt, and the geographic location of the plant. The inputs are primarily salt and water as feedstock, acids and chemical precipitants used to remove impurities in the input brine or output chlorine/caustic soda, as well as refrigerants (CFCs, HCFCs, HFCs, ammonia, etc.) for liquefying and purifying the chlorine gas produced. The chlor-alkali process needs huge amounts of electricity, and hence electrical energy is a major input.

The main pollutant outputs which are common to all three electrolytic processes are emissions of chlorine and refrigerants to air, emissions of noise, emissions of free chlorine, chlorate, bromate, chloride, sulphate, heavy metals, sulphite, organic compounds and halogenated organic compounds to water, as well as the generation of spent acids from chlorine drying and sludges from brine purification. The major pollutant in terms of environmental impact, originating from the mercury cell technique, is mercury. Due to the process characteristics, mercury can be released from the process to air, water, wastes and in products. The diaphragm cell and membrane cell techniques are more concerned with spent materials generation, such as asbestos waste, in the case of asbestos diaphragms.

Table 3.2 gives an overview of the main emission and consumption levels of the three cell techniques using a brine recirculation process. This table represents a summary of Chapter 3.

Table 3.2: Overview of the main emission and consumption levels in chlor-alkali plants in the EU-27 and EFTA countries in 2008 to 2011 using a brine recirculation system

	Mercury	Diaphragm	Membrane	Comments
Consumption, per tonne of chlorine produced				
Salt (NaCl)	1 610–2 340 kg			Depends on impurities and additional sources; stoichiometric consumption: 1 650 kg; 3 100–3 800 kg/t for plants using a once-through brine process
Salt (KCl)	2 070–2 200 kg			Depends on impurities and additional sources; stoichiometric consumption: 2 100 kg
Water	0–2.7 m ³			Refers to the generation of process waste water; ~ 10 m ³ /t for plants using a once-through brine process
Steam for caustic concentration	NA	2.7–5.3 t	0.5–1.7 t	For 50 wt-% caustic
Electricity for electrolysis	3 000–4 400 AC kWh	2 600–3 100 AC kWh	2 300–3 000 AC kWh	Depends on the current density; chlorine liquefaction/evaporation and auxiliary processes excluded
Asbestos	NA	0.1–0.3 kg	NA	Only if asbestos diaphragms are used
Emissions to air, per tonne of chlorine produced				
Hydrogen	< 0.3–14 kg			< 1 % to > 50 % of the co-produced hydrogen is emitted
Chlorine	0.010–15 g			Refers to channelled emissions
Mercury	0.11–1.78 g	NA	NA	Refers to emissions per tonne of annual chlorine capacity in 2010
Emissions to water, per tonne of chlorine produced				
Free chlorine	0.001 0–3.8 g			—
Chlorate	0.92–3 500 g			—
Bromate	0.05–0.3 g			Depends on the purity of the salt (bromide)
Chloride	0.63–1 060 kg			~ 1 000 kg/t for plants using a once-through brine process
Sulphate	0.065–7.4 kg			Depends on the purity of the salt
Organic compounds	2.5–34 g			Measured as TOC; depends on the purity of the salt, water and ancillary materials
Halogenated organic compounds	0.2–1.1 g			Measured as AOX; depends on the purity of the salt, water and ancillary materials
Metals	Cd, Cr, Cu, Fe, Ni, Pb, Zn, etc.			Depends on the purity of the salt
Mercury	0.00–1.65 g	NA	NA	Refers to emissions per tonne of annual chlorine capacity in 2010
Waste generation, per tonne of chlorine produced				
Brine filtration sludges	0.020–1.1 kg (NaCl vacuum salt) 15–45 kg (NaCl rock salt)			Depends on the purity of the salt
Brine softening sludges	NA	NA	0.080–1.0 kg	—
Mercury	0–98 g	NA	NA	Refers to waste generation per tonne of annual chlorine capacity in 2010
Asbestos	NA	64–160 g	NA	Refers to waste generation per tonne of annual chlorine capacity; only if asbestos diaphragms are used
NB: NA = not applicable.				
Source: [55, Euro Chlor 2014], [57, CAK TWG 2012], [58, Euro Chlor 2010]				

3.3 Consumption levels of all cell plants

3.3.1 Sodium chloride/potassium chloride

Different types of salt are used to produce the brine for electrolysis (Section 2.5.1) The stoichiometric salt consumption is 1.65 tonnes per tonne of chlorine produced for the electrolysis of NaCl and 2.10 tonnes per tonne of chlorine produced for the electrolysis of KCl. In reality, more salt is usually consumed because it partly leaves the process via the brine purge which is used to control the levels of impurities in the brine. However, in some cases the salt consumption can be understoichiometric due to the addition of HCl and NaOH/KOH to the brine system (Figure 2.1) or due to the recycling of waste water from other production units (Section 4.3.2.1.3). Reported consumption levels for plants with brine recirculation are summarised in Table 3.3.

Table 3.3: Salt consumption in chlor-alkali plants with brine recirculation in the EU-27 and EFTA countries in 2008 to 2011

Salt consumption in kg per tonne of chlorine produced ⁽¹⁾							
Salt	Minimum	10th percentile	25th percentile	Median	75th percentile	90th percentile	Maximum
NaCl ⁽²⁾	1 608	1 651	1 674	1 700	1 787	1 936	2 339
KCl ⁽³⁾	2 066	ND	2 100	2 110	2 124	ND	2 200

⁽¹⁾ Annual average values.
⁽²⁾ 62 data from 58 plants. Four of these plants provided separate data for different electrolysis units.
⁽³⁾ 9 data from 9 plants.
 NB: ND = not enough data.
 Source: [57, CAK TWG 2012]

Diaphragm cell plants sometimes prefer to sell the salt from caustic evaporators and buy new feedstock for economic reasons.

In plants which operate with waste brine using a once-through brine process, the consumption of salt is about twice as much as in plants using a brine recirculation process. Reported consumption levels range from 3.1 to 3.8 tonnes of NaCl per tonne of chlorine produced compared to a median of 1.7 t/t in the case of plants using a brine recirculation system [57, CAK TWG 2012]. Therefore, 1.4–2.1 tonnes of salt per tonne of chlorine produced are wasted, which is equivalent to 45–55 % of the total salt consumption.

In plants using KCl, the amount of salt needed is higher than for plants using NaCl feedstock, due to the higher molecular weight of KCl (stoichiometric salt consumption of 2.10 tonnes per tonne of chlorine produced). Consumption in this case is approximately 2.1–2.2 tonnes of salt per tonne of chlorine produced (Table 3.3). Plants using KCl do not use the waste brine process, as the price of KCl is much higher than that of NaCl.

3.3.2 Water

For the production of the required demineralised water, several water sources can be used, such as groundwater, river water and drinking water. The techniques used to produce demineralised water include ion exchange, membrane filtration and evaporation [3, Euro Chlor 2011].

Water is mainly **added** to the process for [3, Euro Chlor 2011]:

- the preparation of the brine;
- the preparation of some reagents used for the brine purification;
- the production of caustic in the decomposer, in the case of the mercury cell technique;
- the dilution of the produced caustic in the caustic circuit, in the case of the membrane cell technique;
- the direct cooling of chlorine;
- the dilution of caustic if necessary (e.g. for the chlorine absorption unit).

Water can also be used for indirect cooling, which is covered by the EFS BREF [323, EC 2006].

Water which is consumed **leaves** the process either via the products (hydrogen and caustic solution) or as waste water [3, Euro Chlor 2011]:

1. During electrolysis, water is consumed for the synthesis of hydrogen and caustic in a stoichiometric amount of approximately 0.51 m³/t Cl₂ produced (Section 2.1).
2. In addition, water is used as a solvent for the production of caustic. This amount depends on the caustic concentration and the salt concentration therein (Table 3.4) and cannot be reduced unless the caustic is further concentrated and the condensate recycled.

Table 3.4: Consumption of water as solvent for caustic production

NaOH concentration	NaCl concentration	Water consumption ⁽¹⁾		
		m ³ /t NaOH produced ⁽²⁾	m ³ /t NaOH (100 %) produced	m ³ /t Cl ₂ produced ⁽³⁾
7.0	15	0.78	11	13
11	9.0	0.80	7.3	8.2
32	< 0.01	0.68	2.1	2.4
50	1.0	0.49	0.98	1.1
50	< 0.01	0.50	1.0	1.1
99	< 0.01	0.010	0.010	0.011

⁽¹⁾ Assuming a water density of 1 t/m³.
⁽²⁾ Refers to the given mass concentration of caustic.
⁽³⁾ Assuming a production of 1.128 t NaOH (100 %)/t Cl₂ produced.

3. Regarding the generation of waste water, the average volume oscillated between 1.87 and 2.04 m³/t Cl₂ produced in the EU-27 and EFTA countries during the period from 2002 to 2010 [73, Debelle 2011]. For waste brine processes, approximately 10 m³ of water per tonne of chlorine produced are discharged as waste water.

In addition to its use for the process, water is also used for the washing of equipment and work places [3, Euro Chlor 2011].

The reported volumes of generated waste water are summarised in Table 3.5.

Table 3.5: Waste water generation in chlor-alkali plants in the EU-27 and EFTA countries in 2008 to 2011

Annual average waste water generation in m ³ /t chlorine produced ⁽¹⁾ ⁽²⁾							
Waste water source	Min.	10th percentile	25th percentile	Median	75th percentile	90th percentile	Max.
Brine purge / depleted brine	0	0	0.023	0.33	1.1	9.0	12
Regeneration of ion-exchange resins for process water demineralisation	0	0	0	0	0	0.35	1.26
Backwashing water from filters from primary brine purification	0	0	0	0	0	0.0072	0.10
Regeneration of ion-exchange resins from secondary brine purification (brine softening)	0	0	0	0	0.056	0.19	0.41
Condensate from chlorine cooling	0	0	0	0	0	0.015	0.30
Condensate from hydrogen cooling	0	0	0	0	0	0	0.14
Condensate from caustic evaporation	0	0	0	0	0	0	0.030
Bleach from chlorine absorption unit	0	0	0	0	0	0	0.27
Sulphuric acid from chlorine drying	0	0	0	0	0	0	0
All process waste waters	0.0070	0.064	0.27	0.62	1.8	9	12
⁽¹⁾ Coverage: all three cell techniques; both brine recirculation and once-through brine plants. ⁽²⁾ For a better understanding of the data, refer to Table 3.1. ⁽³⁾ 18 data from 16 plants. 2 of these plants provided separate data for different electrolysis units. Source: [57, CAK TWG 2012]							

The most important contributor to the process waste water is usually the brine purge, which is typically less than 1 m³/t chlorine produced (Table 3.5). Some plants are able to operate without any brine purge, while in the case of plants using a once-through brine system, the waste water stream may account for approximately 10 m³/t chlorine produced. Condensates, bleach from the chlorine absorption unit and spent sulphuric acid from chlorine drying are mostly recycled or used for other purposes (Sections 4.3.2.2.3 and 4.3.7).

3.3.3 Ancillary materials

The use and consumption levels of the main ancillary materials are listed in Table 3.6 and Table 3.7.

Table 3.6: Use of main chemical auxiliaries in chlor-alkali plants using a brine recirculation process

Substance	Use
Sodium (hydrogen) carbonate ($\text{NaHCO}_3/\text{Na}_2\text{CO}_3$)	Precipitation of calcium ions as calcium carbonate (CaCO_3) - essential if vacuum salt is not used - may be prepared <i>in situ</i> by dissolving CO_2 in caustic - $\text{KHCO}_3/\text{K}_2\text{CO}_3$ is used in the case of plants electrolysing KCl brine
Barium salts ($\text{BaCl}_2, \text{BaCO}_3$)	Precipitation of sulphate as barium sulphate (BaSO_4) in the case of high levels in brine - not always used (high price and toxicity) - alternatives include purging of the brine, crystallisation of sodium sulphate, as well as nanofiltration combined with purging of the brine or sulphate precipitation
Calcium chloride (CaCl_2)	Precipitation of sulphate as calcium sulphate (CaSO_4) in the case of high levels in brine - CaCl_2 can be used in place of barium salts or direct purge
Hydrochloric acid (HCl)	<ul style="list-style-type: none"> • pH adjustment of brine entering cells • Dechlorination of brine in the membrane and mercury cell technique • Regeneration of ion-exchange resins • Effluent neutralisation
Sodium (hydrogen) sulphite ($\text{NaHSO}_3/\text{Na}_2\text{SO}_3$)	<ul style="list-style-type: none"> • Final stage of brine dechlorination in the membrane cell technique • Treatment of waste water containing free chlorine - other reducing agents or filtration with activated carbon can be used
Sodium hydroxide (NaOH)	<ul style="list-style-type: none"> • Precipitation of magnesium and heavy metals (iron mainly if an anti-caking agent is used for salt transportation) as their respective hydroxides, e.g. $\text{Mg}(\text{OH})_2$ • pH control in brine circuit • Regeneration of ion-exchange resins • KOH is used in the case of plants electrolysing KCl brine
Sulphuric acid (H_2SO_4 , 92–98 wt-%)	<ul style="list-style-type: none"> • Chlorine drying processes • Effluent neutralisation

Table 3.7: Consumption of main chemical auxiliaries in chlor-alkali plants in the EU-27 and EFTA countries in 2008 to 2011

Consumption in kg per tonne of chlorine produced ⁽¹⁾ ⁽²⁾							
Substance	Minimum	10th percentile	25th percentile	Median	75th percentile	90th percentile	Maximum
Na ₂ CO ₃ ⁽³⁾	0.30	0.81	3.9	12	14	19	39
K ₂ CO ₃ ⁽⁴⁾	15						
BaCO ₃ ⁽⁵⁾	0.3 and 3.3 and 5						
CaCl ₂ ⁽⁶⁾	4.5						
HCl ⁽⁷⁾	5.8	12	22	28	34	46	56
NaHSO ₃ / Na ₂ SO ₃ ⁽⁸⁾	0.020	0.12	0.32	0.90	1.4	2.0	4.2
NaOH ⁽⁹⁾	7.1	9.0	11	16	25	33	55
KOH ⁽¹⁰⁾	15 and 35						
H ₂ SO ₄ ⁽¹¹⁾	3.5	8.0	13	23	30	35	51

⁽¹⁾ Coverage: all three cell techniques; both brine recirculation and once-through brine plants.
⁽²⁾ Annual average values expressed on a 100 % basis (without water).
⁽³⁾ 14 data from 12 plants. Two of these plants provided separate data for different electrolysis units.
⁽⁴⁾ Data from one plant.
⁽⁵⁾ Data from three plants.
⁽⁶⁾ Data from one plant.
⁽⁷⁾ 26 data from 24 plants. Two of these plants provided separate data for different electrolysis units.
⁽⁸⁾ 17 data from 15 plants. Two of these plants provided separate data for different electrolysis units.
⁽⁹⁾ 21 data from 19 plants. Two of these plants provided separate data for different electrolysis units.
⁽¹⁰⁾ Data from two plants.
⁽¹¹⁾ 34 data from 31 plants. Three of these plants provided separate data for different electrolysis units.
Source: [57, CAK TWG 2012]

In general, the consumption of ancillary materials depends on the specific plant layout and, in particular, on the purity of the salt, with vacuum salt requiring only limited quantities [3, Euro Chlor 2011]. In this respect, the consumption of sodium carbonate depends on the calcium content of the salt, while the consumption of barium salts and calcium chloride (for plants that use them) depends on its sulphate content. Plants using vacuum salt may choose to omit primary brine purification (precipitation) completely, thereby avoiding the use of the aforementioned ancillary materials (Section 2.5.3.2).

The consumption of sodium (hydrogen) sulphite for brine dechlorination and waste water treatment is usually higher in membrane cell plants than in mercury cell plants [57, CAK TWG 2012]. The consumption of sulphuric acid depends on the share of chlorine which needs to be dried. For example, the production of bleach or hydrochloric acid does not require chlorine drying with sulphuric acid [57, CAK TWG 2012], [121, MicroBio 2012].

Further materials and/or further uses include:

- refrigerants, such as ammonia, carbon dioxide, chlorine, HCFCs and HFCs for chlorine liquefaction;
- carbon tetrachloride (Table 3.8);

Table 3.8: Consumption of carbon tetrachloride by chlor-alkali plants in the EU-27

Purpose	Carbon tetrachloride consumption (make-up) in g/t annual Cl ₂ capacity ⁽¹⁾				
	Min.	25th percentile	Median	75th percentile	Max.
Elimination of nitrogen trichloride ⁽²⁾	19.9	79.7	133	166	191
Recovery of chlorine from tail gas ⁽²⁾	1.02	54.2	230	551	736

⁽¹⁾ Annual average values for the period of 2006 to 2011.
⁽²⁾ Data from two plants.
Source: [61, DG CLIMA 2012]

- hydrogen peroxide for chemical dechlorination and to reduce emissions of chlorine dioxide from the chlorine absorption unit (for 2011, one plant reports a H_2O_2 consumption of 0.41 kg/t chlorine produced, expressed as 100 % H_2O_2 [57, CAK TWG 2012]);
- ferric chloride and polyaluminium chloride as flocculants during waste water treatment;
- hydrazine for the reduction of Hg(II) prior to filtration in the mercury cell technique;
- sulphides for the precipitation of Hg(II) as mercury sulphide in the mercury cell technique (for 2011, one plant reports a Na_2S consumption of 3.4 kg/t chlorine produced [57, CAK TWG 2012]);
- activated carbon for filtration of mercury-containing process streams in the mercury cell technique;
- sodium carbonate which can be used in mercury retorting to react with sulphur dioxide (flue-gas desulphurisation);
- hydrochloric acid for the destruction of chlorate at high temperatures in the membrane cell technique;
- hydrogen for catalytic chlorate reduction in the membrane cell technique.

3.3.4 Energy

3.3.4.1 Overview

The energy consumption in chlor-alkali production originates from four main processes [63, Euro Chlor 2011]:

- energy to prepare and purify the raw materials, mainly the salt (sodium chloride or potassium chloride) (Section 3.3.4.2);
- electrical energy used for the electrolysis process itself (Section 3.3.4.3);
- energy (steam) to obtain the caustic soda (or potash) at its commercial concentration (Section 3.3.4.4);
- energy for auxiliary equipment such as heating devices, pumps, compressors, transformers, rectifiers and lighting (Section 3.3.4.5).

Energy is used both as electricity and as heat (steam). About half of the electricity consumed is converted into the enthalpy of the products. The rest is converted into heat transferred to the air in the building and the products, which have to be cooled. The heat is partly recirculated through preheating of the brine. Surplus heat might also be used for heating surrounding buildings or for the production of steam which could be used for the concentration of caustic soda. Insulation of the salt dissolvers can be used to reduce the heat losses of the brine system [3, Euro Chlor 2011] [62, UN/ECE 1985].

Energy consumption depends on a number of factors such as [63, Euro Chlor 2011]:

- the cell technique used;
- the purity of the salt used as raw material;
- the specific cell parameters, such as nominal current density, anode/cathode gap, adherence of developed gas bubbles on electrode structures, diaphragm/membrane type and thickness, catalytic electrode coatings;
- the age of the diaphragm, the membrane and the catalytic electrode coatings;
- other technical characteristics of the installation such as the configuration of the electrolyzers (monopolar or bipolar, see Section 2.4.3), the number of evaporative stages in the caustic concentration unit and the chlorine liquefaction conditions;
- the actual current density.

The number of influencing factors explains why energy consumption data of chlor-alkali plants vary significantly, even when using the same cell technique [63, Euro Chlor 2011].

3.3.4.2 Energy consumption for preparation and purification of raw materials

The energy required for the extraction of brine or rock salt, for the preparation of vacuum or solar salt, as well as for the purification of solar salt or salt from potash mining wastes is outside the scope of this document. Nevertheless, it is important to keep in mind that the type and quality of raw material used will have an influence on the energy consumption of the electrolysis process itself. Since all salt sources differ in purity and, as the brine purity requirements differ according to the cell technique used, simple or complex raw material preparation and purification are applied.

For example, the production of vacuum salt uses either electricity of approximately 155–175 kWh per tonne of salt produced via mechanical vapour recompression or steam, in a variable quantity between 0.7 and 1.4 tonnes of low-pressure steam (< 5 bar) per tonne of solid salt produced, depending on the number of vaporisation stages installed. There is also some additional electricity consumption for the auxiliary equipment (approximately 30 kWh/t salt) [63, Euro Chlor 2011], [66, Ullmann's 2010]. Some installations produce their own vacuum salt from solution-mined brine.

3.3.4.3 Energy consumption for the electrolysis

3.3.4.3.1 General considerations

The operation of a chlor-alkali plant is dependent on the availability of huge quantities of direct current (DC) electric power, which is usually obtained from a high voltage source of alternating current (AC). The lower voltage required for an electrolyser circuit is produced by a series of step down transformers. Silicon diode or thyristor rectifiers convert the alternating current electricity to direct current for electrolysis [3, Euro Chlor 2011], [10, Kirk-Othmer 2002]. Direct current is distributed to the individual cells of the electrolysers via busbars. There are energy losses across the transformer, the rectification equipment and the busbars. In 2010, the efficiency of rectifier and transformer units varied from approximately 94 % (older units) to 98 %. To remove the dissipated heat, the units are cooled by circulated air or by special water circuits [63, Euro Chlor 2011].

Connections between cells/electrolysers, along with the corresponding energy losses, have to be considered for the measurement of the total energy requirement per tonne of chlorine produced. The definition of the exact measurement point is necessary for an appropriate comparison of energy consumption figures of different plants.

For the usual operating conditions, the specific electricity consumption w (in kWh/t Cl₂ produced), which is the electricity consumed divided by the production rate, is proportional to the cell current density j (in kA/m²) [63, Euro Chlor 2011]:

$$\text{Equation 1: } w = A \times U_0 + A \times K \times j$$

A is a coefficient which depends on the overall electrolysis efficiency, including both the efficiency of the electricity conversion (from high voltage alternating to lower voltage direct current) and the efficiency of the electrolytic reaction itself (efficiency with which the electrons are effectively used to produce chlorine) [63, Euro Chlor 2011], [65, Millet 2008].

U_0 (in V) is a constant term that depends on the cell characteristics. U_0 is composed of the difference in electrode potential and the activation overpotential at zero current. The minimum value of U_0 is imposed by thermodynamics and, for a given cell technique, mostly depends on the material and coating of the electrodes (~ 2.35 V for diaphragm and membrane cells; ~ 3.15 V for mercury cells) [63, Euro Chlor 2011], [65, Millet 2008].

The term $K \times j$ represents the overpotential during electrolysis ($j > 0$), which is composed of the activation and concentration overpotentials at the two electrodes, the resistance overpotential of the anolyte and catholyte, including the contribution from gas bubbles, the resistance overpotential of the separator (diaphragm or membrane) and the resistance overpotential of the electrical conductors. The factor K (in Vm^2/kA) therefore depends on the geometry of and the distance between the electrodes, the nature of the separator between the electrodes (i.e. diaphragm or membrane), the temperature and electrolyte concentrations of the liquids in both the anolyte and the catholyte compartment, as well as the internal equipment pressure. K is essentially determined by the technique of the electrolyzers and is influenced by the operating conditions [63, Euro Chlor 2011], [65, Millet 2008].

As an example, the specific electrical energy consumption w versus current density j for the mercury cell technique is shown in Figure 3.1 [63, Euro Chlor 2011].

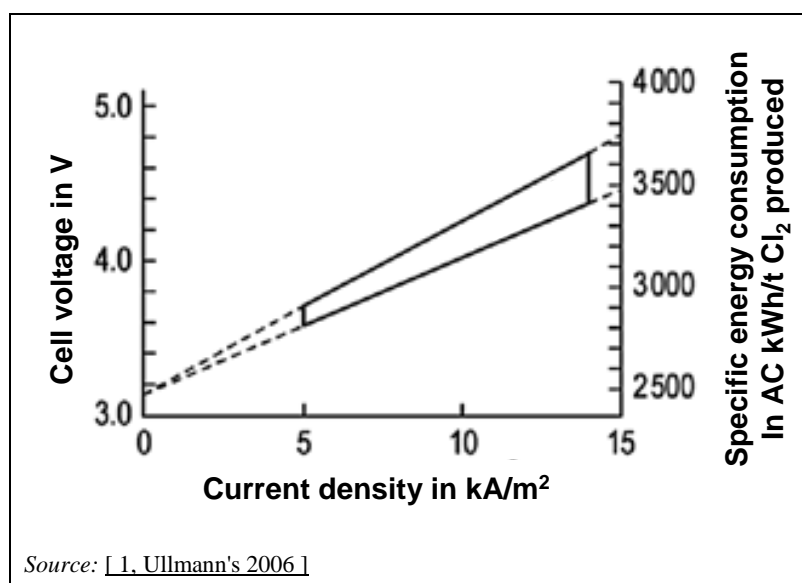

Figure 3.1: Cell voltage and specific electrical energy consumption versus cell current density for the mercury cell technique

For all electrolysis cells, lower current densities mean lower energy consumption, resulting in lower operating costs. However, this leads to larger or an increased number of electrolyzers, resulting in higher investment and maintenance costs, if the same overall production rate is to be achieved. In general, increasing the production rate of a cell by increasing the current density to values higher than the design range leads to a disproportionate increase in the electric resistance losses, and hence to a disproportionately higher specific energy consumption [63, Euro Chlor 2011].

Chlor-alkali plants often operate at varying current densities, depending on the demand for the products and on the fluctuations in electricity prices. Operating conditions and electricity consumption of the electrolysis cells of chlor-alkali plants in the EU-27 and EFTA countries are shown in Table 3.9.

Table 3.9: Operating conditions and electricity consumption of the chlor-alkali electrolysis cells in the EU-27 and EFTA countries

Parameter	Unit	Mercury cell technique ⁽¹⁾			
		Min.	Max.	Average	Median
Theoretical voltage	V	3.15			
Current density min.	kA/m ²	2.2	NI	5.5	4.5
Current density max.	kA/m ²	NI	14.5	10.2	10.7
Cell voltage min.	V	3.15	NI	3.67	3.61
Cell voltage max.	V	NI	4.80	4.15	4.18
Electrical energy use for electrolysis (alternating current)	AC kWh/t Cl ₂ produced	3 024	4 400	3 424	3 401
Parameter	Unit	Diaphragm cell technique ⁽²⁾			
		Min.	Max.	Average	Median
Theoretical voltage	V	2.35			
Current density min.	kA/m ²	0.8	NI	1.1	1.1
Current density max.	kA/m ²	NI	2.7	2.0	1.9
Cell voltage min.	V	2.9	NI	2.98	2.99
Cell voltage max.	V	NI	3.60	3.44	3.48
Electrical energy use for electrolysis (alternating current)	AC kWh/t Cl ₂	2 621	3 134	2 807	2 770
Parameter	Unit	Membrane cell technique (monopolar and bipolar) ⁽³⁾			
		Min.	Max.	Average	Median
Theoretical voltage	V	2.35			
Current density min.	kA/m ²	1.0	NI	2.7	2.6
Current density max.	kA/m ²	NI	6.5	5.1	5.5
Cell voltage min.	V	2.35	NI	2.89	2.90
Cell voltage max.	V	NI	4.00	3.40	3.38
Electrical energy use for electrolysis (alternating current)	AC kWh/t Cl ₂ produced	2 279	3 000	2 618	2 600

⁽¹⁾ Data from 34 mercury cell plants. Reference year 2008: 34 plants. 29 plants measured electricity consumption, 4 plants estimated it and 1 plant did not provide information on whether data were measured or estimated.

⁽²⁾ Data from 6 diaphragm cell plants. Reference year 2008: 6 plants. 5 plants measured electricity consumption and 1 plant did not provide information on whether data were measured or estimated.

⁽³⁾ Data from 40 membrane cell plants (monopolar and bipolar). Reference year 2008: 35 plants; reference year 2009: 4 plants; reference year 2010: 1 plant. 32 plants measured electricity consumption, 6 plants estimated it and 2 plants did not provide information on whether data were measured or estimated.

NB: NI = no information provided.

Source: [58, Euro Chlor 2010]

3.3.4.3.2 Energy consumption of mercury cells

The mercury cell technique is characterised by the highest electrical energy consumption, ranging from approximately 3 000 to 4 400 AC kWh/t Cl₂ produced, the median being approximately 3 400 AC kWh/t Cl₂ produced, with current densities ranging from 2.2 to 14.5 kA/m² (Table 3.9). The increased electrical energy consumption is due to the higher value of U_0 compared to diaphragm and membrane cells, which is the result of the different cathodic reaction. The factor K ranges from 0.08 to 0.20 V·m²/kA, and is lower than for the two other cell techniques as there is no physical separator between the electrodes. The median of the minimum and maximum current densities used are 4.5 and 10.7 kA/m², respectively [1, Ullmann's 2006], [63, Euro Chlor 2011].

The voltage increases with a greater distance between the anode and the cathode, resulting in higher electrical energy consumption. On the other hand, a close distance means a higher

frequency of short-circuiting in the mercury cell. Thus, the distance between the electrodes is usually monitored and is often adjusted, either manually or automatically.

The electrical energy consumption of a mercury cell is quite constant over time, except at the end of the lifetime of the anode coatings [300, Euro Chlor 2011].

3.3.4.3.3 Energy consumption of diaphragm cells

The electrical energy consumption of diaphragm cells ranges from approximately 2 600 to 3 100 AC kWh/t Cl₂ produced, the median being approximately 2 800 AC kWh/t Cl₂ produced, with current densities ranging from 0.8 to 2.7 kA/m² (Table 3.9). The term U_0 is the same for all cells, because of the same electrode materials and coatings. As operating conditions (temperature and concentration of brine) are also quite similar, the factor K is also quite similar for all units (0.4–0.5 V·m²/kA), and the energy consumption depends essentially on the current density. Most diaphragm cell plants in the EU-27 operate with monopolar electrolysers with current densities of 1.5–2.7 kA/m². Bipolar electrolysers are operated with lower current densities of 0.8–2 kA/m². The specific electrical energy consumption of cells with non-asbestos diaphragms is approximately 100–150 kWh/t Cl₂ produced lower than that of cells with asbestos diaphragms at the same current density (Section 4.2.2) [63, Euro Chlor 2011].

The electrical energy consumption of a diaphragm cell rises with the lifetime of the diaphragms due to the accumulation of impurities. In the case of asbestos-free diaphragms, the increase of the resistance overpotential is roughly the same as for membranes used in membrane cells. Nevertheless, it is possible to reclaim the diaphragm to recover almost the original performance. In the case of asbestos diaphragms, the increase in the overpotential is less critical due to the usually shorter lifetime (0.5–1 year at ~ 2.7 kA/m²). The performance of the anode coatings is quite constant, except at the end of their lifetime, similar to the behaviour of anode coatings used in mercury cells. No coatings are used for the cathodes [300, Euro Chlor 2011].

3.3.4.3.4 Energy consumption of membrane cells

The electrical energy consumption of membrane cells ranges from approximately 2 300 to 3 000 AC kWh/t Cl₂ produced, the median being approximately 2 600 AC kWh/t Cl₂ produced, with current densities ranging from 1.0 to 6.5 kA/m² (Table 3.9). All electrolysers are equipped with titanium anodes coated with a catalyst, and the nickel cathodes are usually activated with a catalyst to improve the terms U_0 and K , and so consequently reduce the energy consumption. For non-activated cathodes, U_0 is approximately the same for all units and is similar to the diaphragm electrolysers; it has a lower value if the cathode is activated, depending also on the type of catalyst used. Compared to the diaphragm cells, the factor K of membrane cells has a lower value due to a thinner separator (the membrane), a shorter distance between anode and cathode, and due to a lower electric resistance in the electrolyser structure (0.1–0.3 V·m²/kA) [63, Euro Chlor 2011].

The operating conditions and electrical energy consumptions of monopolar and bipolar electrolysers are different (Table 3.10). For monopolar membrane cells, the electrical energy consumption ranges from approximately 2 700 to 3 000 AC kWh/t Cl₂ produced, the median being approximately 2 800 AC kWh/t Cl₂ produced, with current densities ranging from 1.0 to 4.0 kA/m². For bipolar membrane cells, the electrical energy consumption ranges from approximately 2 300 to 2 900 AC kWh/t Cl₂ produced, the median being approximately 2 500 AC kWh/t Cl₂ produced, with current densities ranging from 1.4 to 6.5 kA/m².

Within both techniques, there are differences in the design distance of the cathode to the membrane. These differences vary from 0 to almost 2 mm. This distance significantly affects the energy consumption (the shorter the distance the lower the energy requirement), as well as the operational requirements, such as brine purity, and the risk of membrane damage [63, Euro Chlor 2011].

The electrical energy consumption of a membrane cell rises with the lifetime of the membranes and the electrodes (coating ageing), by approximately 3–4 % during a period of three years [1, Ullmann's 2006].

Table 3.10: Operating conditions and electricity consumption of monopolar and bipolar chlor-alkali membrane electrolysis cells in the EU-27 and EFTA countries

Parameter	Unit	Membrane cell technique (monopolar) ⁽¹⁾			
		Min.	Max.	Average	Median
Theoretical voltage	V	2.35			
Current density min.	kA/m ²	1.0	NI	1.9	2.0
Current density max.	kA/m ²	NI	4.0	3.7	3.7
Cell voltage min.	V	2.80	NI	2.98	2.96
Cell voltage max.	V	NI	3.6	3.45	3.48
Electrical energy use for electrolysis (alternating current)	AC kWh/t Cl ₂ produced	2 670	3 000	2 820	2 817
Parameter	Unit	Membrane cell technique (bipolar) ⁽²⁾			
		Min.	Max.	Average	Median
Theoretical voltage	V	2.35			
Current density min.	kA/m ²	1.4	NI	2.9	2.8
Current density max.	kA/m ²	NI	6.5	5.4	5.9
Cell voltage min.	V	2.35	NI	2.86	2.85
Cell voltage max.	V	NI	4.00	3.40	3.38
Electrical energy use for electrolysis (alternating current)	AC kWh/t Cl ₂ produced	2 279	2 865	2 574	2 573

⁽¹⁾ Data from 7 monopolar membrane cell plants. Reference year 2008: 6 plants; reference year 2009: 1 plant. 7 plants measured electricity consumption.

⁽²⁾ Data from 33 bipolar membrane cell plants. Reference year 2008: 29 plants; reference year 2009: 3 plants; reference year 2010: 1 plant. 25 plants measured electricity consumption, 6 plants estimated it and 2 plants did not provide information on whether data were measured or estimated.

NB: NI = no information provided.

Source: [58, Euro Chlor 2010]

3.3.4.3.5 Comparison of electrolysis cells

Figure 3.2 summarises the relationship between specific electricity consumption levels and current densities for the different chlor-alkali electrolysis techniques.

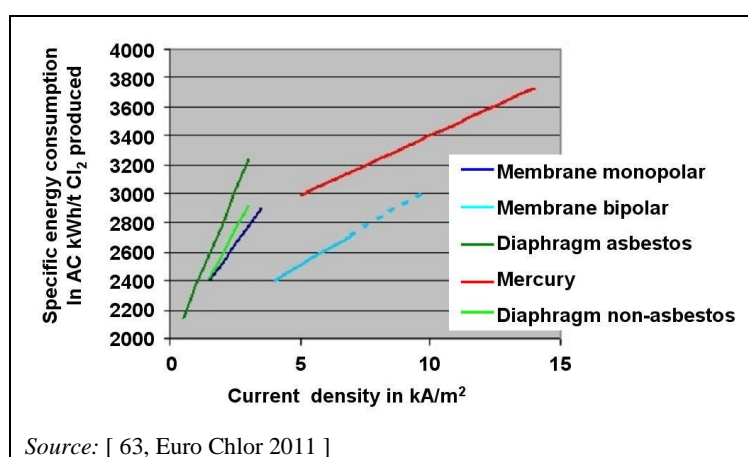

Figure 3.2: Specific electrical energy consumption versus cell current density for the different chlor-alkali electrolysis techniques

3.3.4.3.6 Production of caustic potash

The specific electrical energy consumption for the production of caustic potash does not differ significantly from the production of caustic soda. In the mercury cell technique, the U_0 term is approximately 0.1 V higher. As compensation, the electrical conductivity of KCl is higher (approximately 30 % at 70 °C). In practice, the cell characteristics, such as the distance between anode and cathode, play a more important role than the U_0 term and the electrical conductivity of KCl [1, Ullmann's 2006], [42, Euro Chlor 2010].

3.3.4.4 Energy consumption for caustic soda concentration

The mercury cell technique allows for a direct production of 50 wt-% caustic soda (or potash), but this is not the case for the two other cell techniques where a concentration step may be necessary to bring the caustic up to this commercial standard. The steam consumption for the concentration of the caustic soda to 50 wt-% varies according to the number of evaporation stages and the steam pressure used. For caustic from diaphragm cells, three to four evaporation stages are usually used and the steam consumption ranges from 2.3 to 4.7 tonnes of steam per tonne of caustic (100 %), the median being 2.6 tonnes per tonne of caustic (Table 3.11). For caustic from membrane cells, one to three evaporation stages are used and the steam consumption ranges from 0.4 to 1.5 tonnes of steam per tonne of caustic (100 % basis), the median being 0.7 tonnes per tonne of caustic [63, Euro Chlor 2011].

Table 3.11: Caustic concentration at the cell outlet and steam consumption for caustic concentration in chlor-alkali plants in the EU-27 and EFTA countries

Parameter	Unit	Mercury cell technique ⁽¹⁾			
		Min.	Max.	Average	Median
Caustic concentration at the cell outlet	wt-%	49.0	51.0	49.9	50.0
Steam consumption for caustic evaporation (50 %)	t steam/t caustic (100 %)	NA	NA	NA	NA
Parameter	Unit	Diaphragm cell technique ⁽²⁾			
		Min.	Max.	Average	Median
Caustic concentration at the cell outlet	wt-%	7.1	11.0	10.0	10.5
Steam consumption for caustic evaporation (50 %)	t steam/t caustic (100 %)	2.350	4.690	3.091	2.627
Temperature of steam	°C	165	300	245	285
Pressure of steam	bar	8.0	25.0	15.3	16.0
Parameter	Unit	Membrane cell technique (monopolar and bipolar) ⁽³⁾			
		Min.	Max.	Average	Median
Caustic concentration at the cell outlet	wt-%	24.0	33.0	31.8	32.0
Steam consumption for caustic evaporation (50 %)	t steam/t caustic (100 %)	0.460	1.500	0.736	0.703
Temperature of steam	°C	145	285	199	190
Pressure of steam	bar	3.0	30.0	10.4	10.0
⁽¹⁾ Data from 34 mercury cell plants. Reference year 2008: 34 plants. ⁽²⁾ Data from 6 diaphragm cell plants. Reference year 2008: 6 plants. ⁽³⁾ Data from 40 membrane cell plants (monopolar and bipolar). Reference year 2008: 35 plants; reference year 2009: 4 plants; reference year 2010: 1 plant. NB: NA = not applicable. Source: [58, Euro Chlor 2010]					

3.3.4.5 Energy consumption for auxiliary equipment

The amount and complexity of equipment varies from one installation to another. The electrical energy consumption for electrical equipment other than the electrolysis cells and without chlorine liquefaction ranges from approximately 60 to 600 kWh/t Cl₂ produced, the median being approximately 200 kWh/t Cl₂ produced (Table 3.12). There is no major difference between the three cell techniques.

For the treatment of the brine and to maintain the electrolysis process in the best operating conditions with respect to current efficiency, the brine and the equipment are usually heated with steam. For this process, energy consumption is higher at low current densities and higher for membrane cell plants than for diaphragm cell plants due to the lower Joule heating. Reported consumption figures range from approximately 0.1 to 1.3 t steam/t Cl₂ produced, the median being approximately 0.2 t steam/t Cl₂ produced (Table 3.12).

Liquefaction of chlorine is used to facilitate the transportation of the product and/or to remove inert gases such as oxygen and carbon dioxide, especially in the case of the diaphragm and membrane cell techniques. Reported electrical energy consumption figures for chlorine liquefaction range from approximately 10 to 200 kWh/t Cl₂ liquefied, the median being approximately 50 kWh/t Cl₂ liquefied. Steam consumption for chlorine evaporation ranges from approximately 0.1 to 0.8 t steam/t Cl₂ vaporised, the median being approximately 0.2 t steam/t Cl₂ vaporised (Table 3.12) [63, Euro Chlor 2011].

Table 3.12: Energy consumption for auxiliary processes of chlor-alkali plants in the EU-27 and EFTA countries

Parameter	Unit	All cell techniques ⁽¹⁾			
		Min.	Max.	Average	Median
Electrical energy use by other electrical equipment, except for chlorine liquefaction (pumps, compressors, etc.) ⁽²⁾	AC kWh/t Cl ₂ produced	60	596	191	177
Brine and equipment heating	t steam/t Cl ₂	0.080	1.270	0.292	0.226
Temperature of steam	°C	133	285	208	190
Pressure of steam	bar	0.6	18.0	9.2	8.8
Energy use for chlorine liquefaction ⁽³⁾	AC kWh/t Cl ₂ liquefied	8	200	67	53
Steam consumption for chlorine evaporation	t steam/t Cl ₂ vaporised	0.058	0.830	0.214	0.160
⁽¹⁾ Data from 80 plants in the EU-27 and EFTA countries. Reference year 2008: 75 plants; reference year 2009: 4 plants; reference year 2010: 1 plant. ⁽²⁾ 44 plants measured electricity consumption and 32 estimated it. ⁽³⁾ 23 plants measured electricity consumption and 36 estimated it. Source: [58, Euro Chlor 2010]					

3.3.4.6 Comparison of the three cell techniques

When attempting to deal with comparisons of energy consumption, it is fundamental to define both the reference conditions and the boundaries of the comparison. In this section, energy consumption for the mercury, diaphragm and membrane cell techniques is based on the energy necessary to produce one tonne of dry and compressed chlorine with its co-products: dry hydrogen at low pressure and 50 wt-% caustic soda or potash, starting from salt, water, electricity and steam. Neither the energy required to extract, purify and transport the raw materials nor the energy required for liquefaction and vaporisation of chlorine is included in this comparison. In the case of the diaphragm and membrane cell techniques, liquefaction and evaporation are often necessary to obtain chlorine with a purity similar to the one obtained by using the mercury cell technique.

If global energy consumption figures are to be determined for each chlor-alkali manufacturing technique, steam and electricity have to be expressed in the same units. The most logical way is to refer to the primary energy necessary to produce both steam and electricity. For this purpose, a power generation efficiency of 40 % and a steam production efficiency of 90 % was assumed, just as in a 2009 publication of the International Energy Agency [64, IEA 2009].

This leads to a primary energy consumption of 9.0 GJ per MWh of electricity consumed and, considering an exergy of 2.5 GJ/t steam (at 10 bar and with condensate return at 90 °C), approximately 2.8 GJ per tonne of steam consumed [63, Euro Chlor 2011]. Furthermore, steam consumption based on caustic produced was converted to steam consumption based on chlorine produced by multiplying it by the stoichiometric factor of 1.128. A comparison of the total energy consumption of the three cell techniques is shown in Table 3.13.

Table 3.13: Total energy consumption of chlor-alkali plants in the EU-27 and EFTA countries

Process equipment		Electrolysis cells ⁽¹⁾	Other electrical equipment ^{(1) (2)}	Caustic soda concentration ^{(1) (3)}	Total	
Mercury cell technique	Electricity	AC kWh/t Cl ₂ produced	3 400	200	NA	3 600
	Steam	t/t NaOH (50 wt-%) produced	NA	NA	0	0
	Primary energy ⁽⁴⁾	GJ/t Cl ₂ produced	30.6	1.8	0	32.4
Diaphragm cell technique	Electricity	AC kWh/t Cl ₂ produced	2 800	200	NA	3 000
	Steam	t/t NaOH (50 wt-%) produced	NA	NA	2.6	2.6
	Primary energy ⁽⁴⁾	GJ/t Cl ₂ produced	25.2	1.8	8.1	35.1
Membrane cell technique	Electricity	AC kWh/t Cl ₂ produced	2 600	200	NA	2 800
	Steam	t/t NaOH (50 wt-%) produced	NA	NA	0.70	0.70
	Primary energy ⁽⁴⁾	GJ/t Cl ₂ produced	23.4	1.8	2.2	27.4

⁽¹⁾ Median values of chlor-alkali plants in the EU-27 and EFTA countries. The values may vary considerably from one plant to another, depending on the current density and other plant-specific factors.
⁽²⁾ Energy consumption for chlorine liquefaction/vaporisation is not included.
⁽³⁾ Caustic concentration may not be necessary.
⁽⁴⁾ Assuming an exergy of 2.5 GJ/t steam (at 10 bar and with condensate return at 90 °C), a power generation efficiency of 40 %, a steam generation efficiency of 90 % and a production ratio of 1.128 t NaOH/t Cl₂.
 NB: NA = not applicable.

The mercury cell technique is characterised by the highest electrical energy consumption. However, no steam is required to concentrate the caustic solution. The consumption of electrical energy with the diaphragm cell technique is lower, but the total energy consumption is higher due to the steam required to concentrate the caustic. The consumption of electrical energy of the membrane cell technique is the lowest and the amount of steam needed for concentration of the caustic solution is moderate, resulting in the lowest total energy consumption. While these general conclusions are widely accepted, it is necessary to go into more detail when it comes to evaluating the energy consumption of a specific plant.

3.4 Emissions and waste generation from all cell plants

3.4.1 Overview

Section 3.4 deals with emissions and waste generation from all cell plants. Emissions and waste generation specific to the mercury cell technique are described in Section 3.5, specific to the diaphragm cell technique in Section 3.6 and specific to the membrane cell technique in Section 3.7. Major potential sources of emissions and waste in membrane cell plants are shown in Figure 3.3.

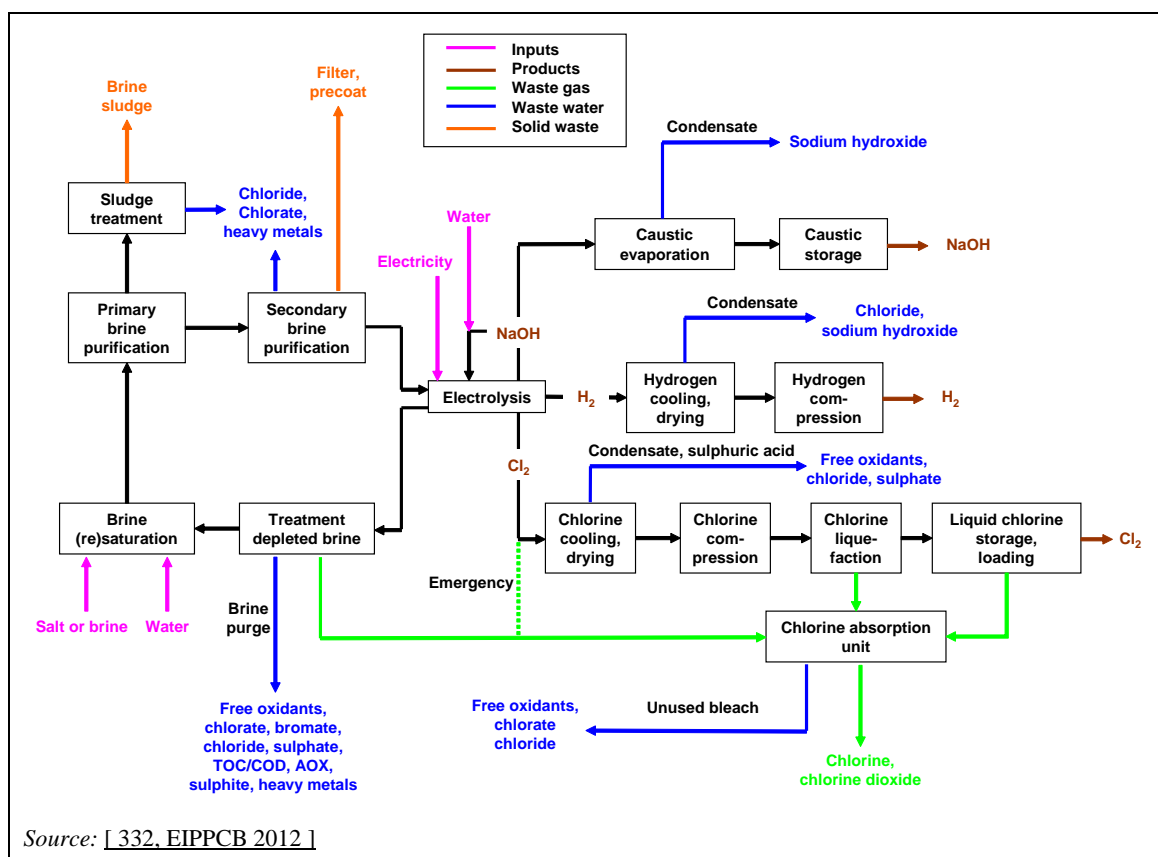

Figure 3.3: Major potential sources of emissions and waste in a membrane cell plant

The presence of a waste gas, waste water or solid waste stream depends on the specific layout of each plant. Although Figure 3.3 shows the major potential sources of emissions and waste for a membrane cell plant, most of them also occur in mercury and diaphragm cell plants (except for mercury which occurs in mercury cell plants and asbestos which occurs in diaphragm cell plants using asbestos). However, in diaphragm cell plants there is usually no brine purge and in mercury cell plants no condensate from caustic concentration. Moreover, diaphragm and mercury cell plants usually do not carry out secondary brine purification, while some mercury and membrane cell plants using vacuum salt do not carry out primary brine purification. Several of the waste water (e.g. condensates, spent sulphuric acid and bleach from the chlorine absorption unit) and waste gas streams (e.g. chlorine from treatment of depleted brine) may be partially or fully recycled within the process or elsewhere.

3.4.2 Emissions from the storage and handling of solids

Emissions from the storage and handling of solids include dust emissions to air originating from salt and ancillary materials, as well as emissions to water caused by the seepage of rainwater and discharge with run-off water. Percolation into the soil can be prevented by an impermeable layer (sometimes with hardened salt) under the salt [3, Euro Chlor 2011].

3.4.3 Emissions and waste generation from the brine circuit

3.4.3.1 Overview

Emissions from the brine circuit to air include fugitive emissions of chlorine and carbon dioxide. Emissions to water occur via the brine purge. The emission levels depend on the purity of the incoming salt used, the cell technique used (mercury, diaphragm or membrane), the techniques used for brine purification and whether the brine is recirculated or wasted. Brine sludges which are generated during brine purification are one of the largest waste streams of the chlor-alkali industry.

3.4.3.2 Emissions to air

Emissions to air from the brine circuit include mainly fugitive emissions of carbon dioxide and chlorine. Carbon dioxide is emitted from the brine acidification tanks due to the decomposition of carbonate and hydrogen carbonate ions to water and carbon dioxide. The carbonate and hydrogen carbonate stem from the auxiliary chemicals used in the brine purification step (Table 3.6). The carbon dioxide either escapes from the brine and is emitted to the atmosphere or is led to the chlorine absorption unit, depending on the presence of chlorine in the brine. The concentration of (hydrogen) carbonate is expected to be lower when the depleted brine is recirculated and resaturated with solid salts (membrane and mercury cells). CO₂ emissions due to brine acidification are approximately 1.2 kg per tonne of chlorine produced [75, COM 2001].

When the mercury cell technique is used, mercury emissions may occur from brine resaturators and salt dissolvers if there is no oxidising species (Section 3.5.6.3.2).

Because chlorine is a hazardous gas, leakage from electrolytic cells is avoided. However, small amounts of chlorine might be emitted through leakages from the brine system and the cells, if these are under pressure. In some cases, chlorine detectors are placed in the cell room, giving an immediate indication of any significant leakage. The chlorine concentration in the cell room can be below the odour detection level if the cells are operated under a slight vacuum. Odour detection levels are in the range of 0.2–3.5 ml/m³ (ppmv), equivalent to 0.6–11 mg/m³ [1, Ullmann's 2006]. Due to their diffuse nature, emissions from the cell room and the brine circuit are difficult to measure but may nevertheless contribute significantly to the overall chlorine emissions to air. One plant reports chlorine concentrations in the cell room of 0.08–0.1 ppmv and an average emission load of 3.1 g/t annual chlorine capacity, while another reports emission loads from the cell room ranging from 3.6 to 14 g/t annual chlorine capacity [57, CAK TWG 2012].

3.4.3.3 Emissions to water

3.4.3.3.1 Overview

Potential sources of waste water in chlor-alkali plants include (Section 3.3.2):

- brine purge in mercury and membrane cell plants using a brine recirculation system;
- depleted brine in mercury and membrane cell plants using a once-through brine system;
- (back)washing water from primary brine purification;
- backwashing water of ion-exchange resins from secondary brine purification, in the case of membrane cell plants;
- backwashing water of ion-exchange resins from water demineralisation;
- water from the condensers during chlorine cooling;
- diluted sulphuric acid from chlorine drying;
- water from the condensers during hydrogen cooling;
- water from the condensers during caustic soda evaporation in diaphragm and membrane cell plants;
- water from the recrystallisation of salt recovered during caustic evaporation in diaphragm cell plants;
- bleach produced by the chlorine absorption unit if it cannot be used or sold;
- water from cleaning of equipment.

Relevant pollutants include sulphate, chloride, free chlorine, chlorate, bromate, heavy metals, organic compounds, halogenated organic compounds and sulphite which are described in more detail below (Figure 3.3). Pollutant emissions specific to the mercury and diaphragm cell techniques are described in Sections 3.5.7 and 3.6.4, respectively.

3.4.3.3.2 Sulphate

Brine is generally purged in NaCl electrolysis to reduce the levels of sodium sulphate and/or sodium chlorate in the cells. However, brine purge is generally avoided in KCl electrolysis due to the costs of the salt. The source of sulphate in brine is the salt used. Sulphate has a negative effect on the electrolysis process (it damages the anode coating) and its level is carefully controlled. This is normally achieved by a purge from the brine treatment system for mercury and membrane cell plants and by purge from the caustic evaporator for diaphragm cell plants. Sulphate emissions may also be due to the neutralisation and discharge of spent sulphuric acid from chlorine drying. In addition, (hydrogen) sulphite is frequently used for complete dechlorination of the brine in the membrane cell technique, as well as for the treatment of waste water containing free chlorine. In both cases, (hydrogen) sulphite is converted to sulphate. Reported emission concentrations and loads are summarised in Table 3.14.

Table 3.14: Emissions of sulphate to water from chlor-alkali plants in the EU-27 and EFTA countries in 2008 to 2011

Sulphate emission concentrations in g/l ⁽¹⁾ ⁽²⁾							
Value reported ⁽³⁾	Min.	10th percentile	25th percentile	Median	75th percentile	90th percentile	Max.
Min. ⁽⁴⁾	0.030	0.050	0.10	0.55	2.1	3.8	9.0
Max. ⁽⁵⁾	0.070	0.48	0.71	5.2	7.8	24	75
Average ⁽⁶⁾ ⁽⁷⁾	0.42	ND	0.50	2.4	6.0	ND	6.0
Sulphate emission loads in kg per tonne of chlorine produced ⁽¹⁾							
Value reported ⁽³⁾	Min.	10th percentile	25th percentile	Median	75th percentile	90th percentile	Max.
Average ⁽⁷⁾ ⁽⁸⁾	0.065	0.10	0.36	0.61	1.4	4.4	7.4

⁽¹⁾ Coverage: all three cell techniques; both brine recirculation and once-through brine plants.
Data refer to the outlet of the electrolysis plant prior to mixing with other waste water.
Most of the reporting plants perform periodic measurements (mostly weekly and daily). 24-hour composite samples were mostly taken, as well as a few grab samples.

⁽²⁾ Data from 24 plants. 15 of these plants reported ranges with minimum and maximum values, 4 of these plants reported only maximum values, 4 plants reported annual average values and 1 plant reported both, a range and an average.

⁽³⁾ For a better understanding of the data, refer to Table 3.1.

⁽⁴⁾ 16 data from 16 plants.

⁽⁵⁾ 20 data from 20 plants.

⁽⁶⁾ 5 data from 5 plants.

⁽⁷⁾ Annual average values.

⁽⁸⁾ 20 data from 20 plants.

NB: ND = not enough data.

Source: [57, CAK TWG 2012]

Plants using solely vacuum salt show sulphate emission loads in the range of 0.1–1.6 kg/t chlorine produced. In general, higher values, up to 7 kg/t chlorine produced, were reported by plants using rock salt (individually or in combination with other salts). Sulphate emission loads of approximately 5 kg/t chlorine produced were also reported by plants that use sulphuric acid for the neutralisation of waste water or that produce their own vacuum salt [57, CAK TWG 2012].

The discharge of sulphate may be considered problematic, depending on where the releases occur.

3.4.3.3 Chloride

In the case of mercury and membrane cell plants, during purification of the brine, approximately 3–4 % of the brine is purged to avoid the build-up of undesired components, except in the case of KCl electrolysis. This purge usually contains a high concentration of chloride. Generally, after treatment to remove free chlorine, the purge is discharged into the site's waste water system. In the case of diaphragm cell plants, chloride emissions result from the purge of the condensers for chlorine cooling and caustic concentration. Reported emission concentrations and loads are summarised in Table 3.15.

Table 3.15: Emissions of chloride to water from chlor-alkali plants in the EU-27 and EFTA countries in 2008 to 2011

Chloride emission concentrations in g/l ⁽¹⁾ ⁽²⁾							
Value reported ⁽³⁾	Min.	10th percentile	25th percentile	Median	75th percentile	90th percentile	Max.
Min. ⁽⁴⁾	0.020	0.095	0.40	1.3	12	31	115
Max. ⁽⁵⁾	0.12	1.1	7.9	31	103	150	152
Average ⁽⁶⁾ ⁽⁷⁾	0.87	2.9	16	39	117	124	182
Chloride emission loads in kg per tonne of chlorine produced ⁽¹⁾							
Value reported ⁽³⁾	Min.	10th percentile	25th percentile	Median	75th percentile	90th percentile	Max.
Average ⁽⁷⁾ ⁽⁸⁾	0.63	3.3	6.9	13	39	100	1 060 ⁽⁹⁾

⁽¹⁾ Coverage: all three cell techniques; both brine recirculation and once-through brine plants.
Data refer to the outlet of the electrolysis plant prior to mixing with other waste water.
Most of the reporting plants perform periodic measurements (mostly daily). 24-hour composite samples were mostly taken, as well as a few grab samples.

⁽²⁾ Data from 40 plants. 21 of these plants reported ranges with minimum and maximum values, 5 of these plants reported only maximum values, 6 plants reported annual average values (2 of these 6 plants for 2 separate electrolysis units) and 8 plants reported both, a range and an average.

⁽³⁾ For a better understanding of the data, refer to Table 3.1.

⁽⁴⁾ 29 data from 29 plants.

⁽⁵⁾ 34 data from 34 plants.

⁽⁶⁾ 16 data from 14 plants. 2 of these plants provided separate data for different electrolysis units.

⁽⁷⁾ Annual average values.

⁽⁸⁾ 41 data from 38 plants. 3 of these plants provided separate data for different electrolysis units.

⁽⁹⁾ Plant with once-through brine system.

Source: [57, CAK TWG 2012]

Chloride emission loads to water depend on the degree of brine depletion during electrolysis and the volume of the brine purge, which itself is influenced by various factors, such as the purity of the salt, the technique used to control impurities in the brine circuit (e.g. sulphate precipitation, nanofiltration, chlorate destruction) and the cell technique (e.g. generally higher brine purge volumes from membrane cell plants compared to mercury cell plants, due to higher brine quality requirements).

In the case of the process using waste brine, 1.4–2.1 tonnes of salt per tonne of chlorine produced are purged (Section 3.3.1), which is equivalent to chloride emission loads of 850–1 300 kg per tonne of chlorine produced. The discharge of chloride may have some impact on the receiving water body, depending on local conditions.

3.4.3.3.4 Free chlorine

Free chlorine results from the production and dissolution of chlorine in the brine and its subsequent reactions with potential brine impurities, such as bromide.

When measuring chlorine in water samples, several oxidising species are included, depending on the analytical method employed. According to the European standards EN ISO 7393–1, –2 and –3, free chlorine includes hypochlorite, hypochlorous acid and dissolved elementary chlorine, while total chlorine also includes organic and inorganic chloramines. Furthermore, other oxidising species such as hypobromite, hypobromic acid and dissolved elementary bromine are included in the parameter free chlorine. In addition to these brominated species, the parameter total chlorine also includes bromamines [162, CEN 2000], [163, CEN 2000], [164, CEN 2000]. These oxidants may be present in the brine purge.

The purge from the brine purification is normally treated before being discharged to the environment. Reported emission concentrations and loads are summarised in Table 3.16.

Table 3.16: Emissions of free chlorine to water from chlor-alkali plants in the EU-27 and EFTA countries in 2008 to 2011

Concentrations of free chlorine in mg/l ⁽¹⁾ ⁽²⁾							
Value reported ⁽³⁾	Min.	10th percentile	25th percentile	Median	75th percentile	90th percentile	Max.
Min. ⁽⁴⁾	0.030	ND	0.10	0.10	0.10	ND	1.0
Max. ⁽⁵⁾	0.047	0.050	0.18	1.0	5.0	17	653
Average ⁽⁶⁾ ⁽⁷⁾	0.022	ND	0.040	0.045	1.4	ND	141
Free chlorine emission loads in g per tonne of chlorine produced ⁽¹⁾							
Value reported ⁽³⁾	Min.	10th percentile	25th percentile	Median	75th percentile	90th percentile	Max.
Average ⁽⁷⁾ ⁽⁸⁾	0.001 0	0.007 5	0.020	0.065	1.0	3.8	32 ⁽⁹⁾
<p>⁽¹⁾ Coverage: all three cell techniques; both brine recirculation and once-through brine plants. Data refer to the outlet of the electrolysis plant prior to mixing with other waste water. Most of the reporting plants perform continuous (reduction potential) and daily measurements. For periodic measurements, 24-hour composite samples were mostly taken, as well as a few grab samples.</p> <p>⁽²⁾ Data from 30 plants. 21 of these plants reported ranges with minimum and maximum values, 4 plants reported annual average values and 5 plants reported both, a range and an average (1 of these 5 plants for 2 separate electrolysis units).</p> <p>⁽³⁾ For a better understanding of the data, refer to Table 3.1.</p> <p>⁽⁴⁾ 6 data from 6 plants. In addition, 7 plants reported values below the detection limit, 3 plants a value of < 0.01 mg/l, 1 plant a value of < 0.02 mg/ for 2 different electrolysis units, 1 plant a value of < 0.03 mg/l, 1 plant a value of < 0.05 mg/l, 4 plants a value of < 0.1 mg/l, 1 plant a value of < 0.2 mg/l, 1 plant a value of < 2 mg/l and 1 plant a value of < 4 mg/l.</p> <p>⁽⁵⁾ 19 data from 18 plants. 1 of these plants provided separate data for different electrolysis units. In addition, 2 plants reported values below the detection limit, 1 plant a value of < 0.03 mg/l, 3 plants a value of < 0.1 mg/l, 1 plant a value of < 0.2 mg/l and 1 plant a value of < 2 mg/l.</p> <p>⁽⁶⁾ 6 data from 5 plants. 1 of these plants provided separate data for different electrolysis units. In addition, 1 plant reported a value below the detection limit, 1 plant a value of < 0.05 mg/l and 2 plants a value of < 0.2 mg/l.</p> <p>⁽⁷⁾ Annual average values.</p> <p>⁽⁸⁾ 11 data from 11 plants. In addition, 3 plants reported values below the detection limit, 1 plant a value of < 0.008 g/t, 1 plant a value of < 0.025 g/t, 1 plant a value of < 0.08 g/t and 1 plant a value of < 3 g/t chlorine produced.</p> <p>⁽⁹⁾ Plant with once-through brine system.</p> <p>NB: ND = not enough data.</p> <p>Source: [57, CAK TWG 2012]</p>							

The highest emission concentrations of free chlorine were observed for plants which reported that no specific waste water treatment takes place at the plant level, apart from the generally applied partial dechlorination using a vacuum [57, CAK TWG 2012]. In the case of membrane cell plants, the depleted brine is always totally dechlorinated (Section 2.5.4). The release of free chlorine is higher for plants that destroy the produced bleach in the chlorine absorption unit and discharge the remaining liquid, which may contain significant amounts of free chlorine [17, Dutch Ministry 1998].

Free chlorine is toxic to aquatic biota. If waste water containing free chlorine becomes acidic, chlorine is released. Moreover, the mixing of waste water containing free chlorine with other waste water containing organic substances may lead to the formation of halogenated organic compounds. Substances which may form halogenated organic compounds in the aquatic environment are included in Annex II to the Industrial Emissions Directive [77, Directive 2010/75/EU 2010].

3.4.3.3.5 Chlorate and bromate

The main sources of chlorate and bromate are the purge from brine purification and also water streams that have been treated to decompose free chlorine into the less reactive chlorate and bromate. Chlorate (ClO_3^-) and (to a much lesser extent) bromate (BrO_3^-) are formed during electrolysis, particularly when using the diaphragm or membrane cell technique (Section 2.1 and Table 2.1). Bromate is present in only small quantities, as bromine is only present as a contaminant of the salt.

Due to the recycling of the brine, these components build up. Chlorate and bromate are unwanted compounds in the process as their presence reduces the solubility of incoming salt and, in the case of the membrane cell technique, may negatively affect the caustic soda quality, the ion-exchange resins used for brine purification and the membranes. Measures are usually taken to keep the level of chlorate low (usually below 10 g/l in the feed brine). To maintain this level, there is a need to purge an appropriate volume of the brine, which can be carried out alongside operating under acidic conditions in the anolyte (approximately pH 2, see Sections 2.5.3.2 and 4.3.6.4.2) or alongside using a chlorate decomposer (Sections 2.5.5, 4.3.6.4.3 and 4.3.6.4.4). The purge can also be used as a raw material in a plant which produces sodium chlorate (Section 4.3.6.4.5).

In the case of diaphragm cell plants, any bromate or chlorate formed in the anolyte compartment migrates through the diaphragm and may be reduced by nascent hydrogen at the cathode (Section 4.3.6.3.6). Residual levels remain in the caustic liquor which leaves the cell. Reported emission concentrations and loads are summarised in Table 3.17 and Table 3.18.

Table 3.17: Emissions of chlorate to water from chlor-alkali plants in the EU-27 and EFTA countries in 2008 to 2011

Chlorate emission concentrations in g/l ⁽¹⁾ ⁽²⁾							
Value reported ⁽³⁾	Min.	10th percentile	25th percentile	Median	75th percentile	90th percentile	Max.
Min. ⁽⁴⁾	0.010	ND	0.012	0.54	3.0	ND	5.0
Max. ⁽⁵⁾	0.007 0	0.026	0.40	5.0	5.5	7.0	14
Average ⁽⁶⁾ ⁽⁷⁾	0.23	ND	1.0	2.4	4.0	ND	5.0
Chlorate emission loads in g per tonne of chlorine produced ⁽¹⁾							
Value reported ⁽³⁾	Min.	10th percentile	25th percentile	Median	75th percentile	90th percentile	Max.
Average ⁽⁷⁾ ⁽⁸⁾	0.92	26	134	285	1 430	2 500	3 500
⁽¹⁾ Coverage: all three cell techniques; both brine recirculation and once-through brine plants. Data refer to the outlet of the electrolysis plant prior to mixing with other waste water. Most of the reporting plants perform periodic measurements (mostly daily and weekly). For periodic measurements, 24-hour composite samples were mostly taken, as well as a few grab samples. ⁽²⁾ Data from 17 plants. 9 of these plants reported ranges with minimum and maximum values, 6 plants reported annual average values, 1 plant reported both, a range and an average, and 1 plant only a maximum value. ⁽³⁾ For a better understanding of the data, refer to Table 3.1. ⁽⁴⁾ 9 data from 9 plants. In addition, 1 plant reported a value below the detection limit. ⁽⁵⁾ 11 data from 11 plants. ⁽⁶⁾ 7 data from 7 plants. ⁽⁷⁾ Annual average values. ⁽⁸⁾ 18 data from 18 plants. NB: ND = not enough data. Source: [57, CAK TWG 2012]							

Table 3.18: Emissions of bromate to water from chlor-alkali plants in the EU-27 and EFTA countries in 2008 to 2011

Plant	Emission concentrations in mg/l ⁽¹⁾	Emission loads in g per tonne of chlorine produced ⁽¹⁾ ⁽²⁾	Cell technique	Salt source
A	≤ 0.5	0.05 ⁽³⁾	M	V
B	< 1.2–2	0.3	M	V
C	< 1.2	< 0.5	M	V
D	< 3	NI	M	S
E	0.3 ⁽⁴⁾	0.26	M	SMB
F ⁽⁵⁾	2–10	33	M	SMB

⁽¹⁾ Coverage: all three cell techniques; both brine recirculation and once-through brine plants. Data refer to the outlet of the electrolysis plant prior to mixing with other waste water. All of the reporting plants performed periodic measurements (monthly and six-monthly). 24-hour composite samples were taken.

⁽²⁾ Annual average values.

⁽³⁾ Estimated value.

⁽⁴⁾ Annual average value.

⁽⁵⁾ Plant with once-through brine system.

NB: M = membrane cell plant; NI = no information provided; S = solar salt; SMB = solution-mined brine; V = vacuum salt.

Source: [57, CAK TWG 2012]

Particularly relevant with regards to chlorate and bromate are plants that do not use the bleach produced from the chlorine-containing waste gases but instead destroy it by means of heating to 70 °C and acidifying it to pH 6 or 7. In these cases, the free chlorine is converted to chlorate and bromate. A value of 4 kg chlorate per tonne of chlorine produced is reported for a plant applying thermal bleach destruction, while bromate was in the range of 0.22–550 g per tonne of chlorine produced [17, Dutch Ministry 1998].

Chlorate and bromate are less reactive than free chlorine and have a lower acute toxicity for aquatic biota. However, chlorate is classified as toxic to aquatic life with long-lasting effects (chronic toxicity) and bromate is presumed to have carcinogenic potential for humans [76, Regulation EC/1272/2008 2008].

3.4.3.3.6 Heavy metals except mercury

Brine contains a certain amount of dissolved metals, such as nickel, zinc, iron, and copper, which originate from salt impurities and metallic equipment (Table 2.4). The addition of an anti-caking agent (ferrocyanides) to the solid salt for transport, loading and unloading purposes creates an extra source of iron, which is mostly the case if vacuum salt is used. Dissolved heavy metals are unwanted compounds in the process. In the case of the mercury cell technique, they can lead to the release of hydrogen in the anode compartment (Section 2.2.1), while in the case of the membrane cell technique, they negatively affect the performance of the cells (Table 2.4).

Dissolved metals are partly removed by the purge from the brine treatment, although the majority are precipitated as hydroxides (e.g. iron hydroxide, Fe(OH)₃) and are removed during brine filtration. In the case of membrane cell plants, dissolved metals are further removed from the brine during ion exchange and subsequently emitted during regeneration. A decomposition unit for iron complexes may be necessary for membrane cell plants. Reported emission concentrations and loads are summarised in Table 3.19.

Table 3.19: Emissions of heavy metals to water from chlor-alkali plants in the EU-27 and EFTA countries in 2008 to 2011

Heavy metal	Emission concentrations in mg/l ⁽¹⁾	Emission loads in g per tonne of chlorine produced ⁽¹⁾ ⁽²⁾	Cell technique	Salt source
Cd	< 0.02	NI	M, D	SMB
Cr	NI	0.008 2	M	V
	0.001–0.025	NI	M	S
	< 0.1	NI	M, D	SMB
Cu	NI	0.14	M	V
	0.01–0.04	NI	M	S
	0.01–1.4	NI	Hg, D	SMB, S
	0.01–0.22	0.36	M	SMB
Fe	0.1–2	1	M	V
	0.1–4	NI	M	S
Ni	0.01–0.5	0.01	M	V
	NI	0.010	M	V
	0.005–0.01	NI	M	S
	0.12–0.18	NI	M, D	SMB
	0.05 ⁽²⁾	0.007	M	R
Pb	NI	0.016 3	M	V
	0.01–0.05	NI	M	S
	< 0.2	NI	M, D	SMB
Zn	NI	0.039 2	M	V
	0.05–0.4	NI	M	S

⁽¹⁾ Coverage: all three cell techniques; both brine recirculation and once-through brine plants. Data refer to the outlet of the electrolysis plant prior to mixing with other waste water. All of the reporting plants perform periodic measurements (twice per month, monthly, quarterly and six-monthly). Grab samples and 24-hour composite samples were taken.

⁽²⁾ Annual average values.

NB: D = diaphragm cell plant; Hg = mercury cell plant; M = membrane cell plant; NI = no information provided; R = rock salt; S = solar salt; SMB = solution-mined brine; V = vacuum salt.

Source: [57, CAK TWG 2012]

Emission loads of heavy metals to water are determined by the purity of the salt used. Apart from their co-precipitation during brine purification, no additional techniques for their removal are used.

Some of the heavy metals such as cadmium, nickel and lead are priority substances under the Water Framework Directive [74, Directive 2008/105/EC 2008]. Metals and their compounds are also included in Annex II to the Industrial Emissions Directive [77, Directive 2010/75/EU 2010].

3.4.3.3.7 Organic compounds

Organic compounds in waste water originate from the raw materials (salt and water), ancillary materials and equipment used (leaching). They are usually measured as BOD (biochemical oxygen demand), COD (chemical oxygen demand), and TOC (total organic carbon). Reported emission concentrations and loads are summarised in Table 3.20.

Table 3.20: Emissions of organic compounds to water from chlor-alkali plants in the EU-27 and EFTA countries in 2008 to 2011

Parameter	Emission concentrations in mg/l ⁽¹⁾	Emission loads in g per tonne of chlorine produced ⁽¹⁾ ⁽²⁾	Cell technique	Salt source
BOD	1–10	3.6	M	V
COD	30–90	40	M	V
	< 30–111	84	Hg, M	R, V, O
	< dl–90	NI	M	R
TOC	5–20	7	M	V
	4–95	30	M	V
	NI	2.48	Hg	V
	70 ⁽²⁾	34.2	M	R

⁽¹⁾ Coverage: all three cell techniques; both brine recirculation and once-through brine plants. Data refer to the outlet of the electrolysis plant prior to mixing with other waste water. All of the reporting plants perform periodic measurements (daily, twice per week, weekly, monthly). Grab samples and 24-hour composite samples were taken.

⁽²⁾ Annual average values.

NB: BOD = biochemical oxygen demand; COD = chemical oxygen demand; dl = detection limit; Hg = mercury cell plant; M = membrane cell plant; NI = no information provided; O = other salt sources; R = rock salt; TOC = total organic carbon; V = vacuum salt.

Source: [57, CAK TWG 2012]

The emissions of organic compounds from chlor-alkali plants have decreased significantly since the switch from graphite to metal anodes. Emissions depend primarily on the purity of raw and ancillary materials.

Substances which have an unfavourable influence on the oxygen balance and which can be measured using parameters such as BOD, COD, etc. are included in Annex II to the Industrial Emissions Directive [77, Directive 2010/75/EU 2010].

3.4.3.3.8 Halogenated organic compounds

Halogenated organic compounds are formed in a reaction between organic contaminants in the electrolyser or the brine system and free chlorine. Organic contaminants may originate from the raw materials (salt and water), ancillary materials, or the equipment used. Examples of chlorinated hydrocarbons which can be found in the effluent of chlor-alkali plants are chloroform (CHCl₃), dichloromethane (CH₂Cl₂), carbon tetrachloride (CCl₄) and tetrachloroethylene (C₂Cl₄), but other chlorinated and also brominated compounds may be found [17, Dutch Ministry 1998]. Halogenated organic compounds in water are usually measured as AOX (adsorbable organically bound halogens) and EOX (extractable organically bound halogens). Reported emission concentrations and loads are summarised in Table 3.21. Volatile halogenated organic compounds may be transferred from the brine to the gas phase during electrolysis, and especially during brine dechlorination.

Table 3.21: Emissions of halogenated organic compounds to water from chlor-alkali plants in the EU-27 and EFTA countries in 2008 to 2011

Parameter	Emission concentrations in mg/l ⁽¹⁾	Emission loads in g per tonne of chlorine produced ⁽¹⁾ ⁽²⁾	Cell technique	Salt source
AOX	0.04–0.4	0.2	M	V
	0.1–0.5	0.5	M	V
	0.43–0.83	NI	M	R
	NI–1.3	NI	M	R
	NI	1.1	M	R
	0.026–0.11	0.3	M	SMB, O
	0.5–3.5	0.8	Hg	V
	NI	0.8	Hg	V
EOX	0.01–0.05	0.015	M	V
	0.2–0.3	0.22	M	SMB
VOX	0.020–0.13	0.025	M	V

⁽¹⁾ Coverage: all three cell techniques; both brine recirculation and once-through brine plants. Data refer to the outlet of the electrolysis plant prior to mixing with other waste water. All of the reporting plants perform periodic measurements (daily, twice per week, weekly, monthly, six-monthly). Grab samples, as well as half-hourly, hourly and 24-hour composite samples were taken.

⁽²⁾ Annual average values.

NB: AOX = adsorbable organically bound halogens; EOX = extractable organically bound halogens; Hg = mercury cell plant; M = membrane cell plant; NI = no information provided; O = other salt sources; R = rock salt; SMB = solution-mined brine; V = vacuum salt; VOX = volatile organically bound halogens.

Source: [57, CAK TWG 2012]

The emissions of halogenated organic compounds from chlor-alkali plants have decreased significantly since the switch from graphite to metal anodes, but can be higher for plants that destroy the produced bleach in the chlorine absorption unit and discharge the remaining liquid. Emissions depend primarily on the concentrations of organic compounds in the brine, which are usually low due to brine quality requirements (Table 2.4).

Halogenated organic compounds are included in Annex II to the Industrial Emissions Directive [77, Directive 2010/75/EU 2010].

3.4.3.3.9 Sulphite

Sodium (hydrogen) sulphite is frequently used for the removal of free chlorine from waste water. It is usually applied in stoichiometric excess, with the remainder being discharged. One membrane cell plant reported average sulphite concentrations of 2.7 mg/l (weekly measurements) at the outlet of the electrolysis plant, while a second plant reported sulphite concentrations of 0.1–1.0 mg/l with an average of 0.54 mg/l (periodic measurements), and a third reported sulphite concentrations to be < 1 mg/l [57, CAK TWG 2012].

3.4.3.4 Generation of wastes

The quantity of brine filtration sludges mainly depends on the incoming salt. The salts precipitated during purification of the brine are removed in a filter unit or a clarifier. The precipitate consists mainly of calcium carbonate and magnesium hydroxide, and in some cases barium sulphate. In the case of the mercury cell technique, the residual brine in the sludge usually contains some dissolved mercury in its oxidised form. In some plants, this brine is washed out to reduce the mercury contamination. The sludge can be filtered and disposed of as a solid waste, or periodically removed by flushing with a weak hydrochloric acid solution. The acid causes the precipitate to dissolve (except barium sulphate and mercury) and the relatively harmless solution can be discharged with liquid effluent [3, Euro Chlor 2011]. The treatment

of brine filtration sludges containing mercury is described in Section 3.5.9.2. Reported figures on the generation of sludges from primary brine purification are summarised in Table 3.22.

Table 3.22: Generation of sludges from primary brine purification in chlor-alkali plants in the EU-27 and EFTA countries in 2008 to 2011

Salt type	Generation of sludges from primary brine purification in kg per tonne of chlorine produced ⁽¹⁾ ⁽²⁾						
	Min.	10th percentile	25th percentile	Median	75th percentile	90th percentile	Max.
NaCl and KCl, all types ⁽³⁾	0.020	0.091	0.75	12	25	33	57
NaCl, only vacuum salt ⁽⁴⁾	0.020	0.070	0.10	0.18	0.75	1.0	1.1
NaCl, only rock salt ⁽⁵⁾	15	ND	23	27	33	ND	45
NaCl, only solution-mined brine ⁽⁶⁾	10 and 36 and 57						
NaCl, only solar salt ⁽⁷⁾	18 and 30						
NaCl, only from potash mining wastes ⁽⁸⁾	21	ND	23	27	30	ND	33
KCl, all types ⁽⁹⁾	0.050	ND	0.56	1.4	1.5	ND	4.2

⁽¹⁾ Annual average values.
⁽²⁾ 17 plants out of a total of 42 reported solids content in the brine sludge which ranged from 30 wt-% to 100 wt-%.
⁽³⁾ 44 data from 42 plants. 2 of these plants provided separate data for different electrolysis units. 5 of the 42 plants included sludges and/or pre-coat filters from secondary brine purification in the reported values.
⁽⁴⁾ 11 data from 10 plants. 1 of these plants provided separate data for different electrolysis units.
⁽⁵⁾ 9 data from 9 plants. 2 of the 9 plants included sludges and/or pre-coat filters from secondary brine purification in the reported values.
⁽⁶⁾ 5 data from 5 plants.
⁽⁷⁾ 3 data from 3 plants.
⁽⁸⁾ 2 data from 2 plants. 1 of the 2 plants included sludges and/or pre-coat filters from secondary brine purification in the reported values.
⁽⁹⁾ 5 data from 5 plants. 1 of the 5 plants included sludges and/or pre-coat filters from secondary brine purification in the reported values.
 NB: ND = not enough data.
 Source: [57, CAK TWG 2012]

Table 3.22 shows that rock salt, solution-mined brine and salt from potash mining wastes usually generate much higher amounts of brine filtration sludges than vacuum salt. In addition, the membrane cell technique requires more rigorous purification of the brine, and sludge disposal from the filters is thus more significant.

Some plants using vacuum salt omit primary brine purification completely and therefore do not generate any sludges from this treatment step [57, CAK TWG 2012].

3.4.4 Emissions and waste generation from chlorine processing, storage and handling

3.4.4.1 Overview

Air emissions consist of fugitive emissions of carbon dioxide and chlorine from the processing steps, from the storage and handling of chlorine, as well as of channelled emissions from the chlorine absorption unit. Emissions of carbon tetrachloride during chlorine processing occur at a few installations that make use of this substance. Small amounts of chlorine dioxide could also be emitted from the chlorine absorption unit, as well as small amounts of refrigerants from the chlorine liquefaction system.

The condensed water formed after cooling is usually recycled as brine make-up, although some facilities combine this stream with other waste water streams prior to treatment. The remaining water vapour is removed by scrubbing the chlorine gas with concentrated sulphuric acid. The spent sulphuric acid is used for other purposes, is recycled, or is sent to the site's waste water collection system.

3.4.4.2 Emissions to air

3.4.4.2.1 Carbon dioxide

Small amounts of carbon dioxide are released from the anode compartment and are collected and treated together with the chlorine. During chlorine liquefaction, carbon dioxide and other gases (N₂, O₂, H₂) remain in the gas phase and are finally purged from the system, together with a small amount of chlorine. This waste gas stream is usually processed in the chlorine absorption unit. Carbon dioxide that is not absorbed by the chlorine absorption unit is emitted into the atmosphere.

3.4.4.2.2 Chlorine

Because chlorine is a hazardous gas, extreme precaution is taken to prevent emissions of chlorine from the process and from handling and storage. Therefore, emissions of chlorine gas into the atmosphere are generally low. The sources of significant potential emissions are normally connected with the chlorine absorption unit.

When measuring chlorine in the gas phase, other oxidising species are included, depending on the analytical method employed. This holds true for both categories of measurement techniques. The first is based on absorption of a gas stream in a liquid, with subsequent wet chemical analysis, while the second is based on direct measurements in the gas phase with electrochemical cells (Section 4.3.3.4) [[67, Euro Chlor 2010](#)]. Other oxidising species are usually unlikely to be present in relevant concentrations, with the exception of chlorine dioxide (Section 3.4.4.2.3).

Chlor-alkali plants in the EU-27 and EFTA countries have a chlorine absorption unit to destroy the chlorine present in waste gases. Whenever possible, the residual chlorine is first valorised in bleach or hydrochloric acid production units. Subsequently, all chlorine production units have a safety chlorine absorption unit for the removal of chlorine from waste gases during normal operation and also during emergencies. The absorption of chlorine in caustic soda is most commonly used for chlorine destruction [[3, Euro Chlor 2011](#)]. Reported emission levels at the outlet of this unit are highly variable and are often below the detection limit (Table 3.23)

Table 3.23: Emissions of chlorine to air from chlor-alkali plants in the EU-27 and EFTA countries in 2008–2011

Chlorine emission concentrations in mg/m ³ ⁽¹⁾ ⁽²⁾							
Value reported ⁽³⁾	Min.	10th percentile	25th percentile	Median	75th percentile	90th percentile	Max.
Min. ⁽⁴⁾	0.020	0.050	0.17	0.59	0.90	1.5	5.1
Max. ⁽⁵⁾	0.050	0.39	0.56	1.8	3.8	8.2	20
Average ⁽⁶⁾ ⁽⁷⁾	0.024	0.17	0.20	0.50	1.4	4.5	8.4
Chlorine emission loads in g per tonne of chlorine produced ⁽¹⁾							
Value reported ⁽³⁾	Min.	10th percentile	25th percentile	Median	75th percentile	90th percentile	Max.
Average ⁽⁷⁾ ⁽⁸⁾	0.010	0.019	0.059	0.25	1.4	2.9	15
⁽¹⁾ Data refer to the outlet of the chlorine absorption unit under standard conditions (273.15 K, 101.3 kPa) after deduction of the water content. Plants usually perform continuous indicative monitoring with alarm thresholds (e.g. with electrochemical cells), in combination with periodic monitoring (mostly twice per month, quarterly and six-monthly). Sampling periods reported for periodic monitoring were mostly half-hourly, but also included instantaneous (grab sample), and hourly. ⁽²⁾ Data from a total of 54 absorption units. For 27 of these absorption units ranges with minimum and maximum values were reported, for 9 of these absorption units annual average values were reported and for 18 of these absorption units both. ⁽³⁾ For a better understanding of the data, refer to Table 3.1. ⁽⁴⁾ 26 data from 25 plants. 1 of these plants provided separate data for different electrolysis units. In addition, 6 plants reported values below the detection limit, 2 plants a value of < 0.02 mg/m³, 3 plants a value of < 0.1 mg/m³, 1 plant a value of < 0.19 mg/m³, 1 plant a value of < 0.25 mg/m³, 2 plants a value of < 0.3 mg/m³, 2 plants a value of < 0.5 mg/m³ and 1 plant a value of < 0.6 mg/m³. ⁽⁵⁾ 38 data from 36 plants. 2 of these plants provided separate data for different electrolysis units. In addition, 1 plant reported a value of < 0.1 mg/m³, 1 plant a value of < 0.19 mg/m³, 2 plants a value of < 0.3 mg/m³, 1 plant a value of < 0.5 mg/m³, 1 plant a value of < 0.6 mg/m³ and 1 plant a value of < 10 mg/m³. ⁽⁶⁾ 25 data from 24 plants. 1 of these plants provided separate data for different electrolysis units. In addition, 1 plant reported a value of < 2 mg/m³ and 1 plant a value of < 6 mg/m³ ⁽⁷⁾ Annual average values. ⁽⁸⁾ 34 data from 33 plants. 1 of these plants provided separate data for different electrolysis units. In addition, 1 plant reported a value of < 0.13 g/t.							
Source: [57, CAK TWG 2012]							

Other chlorine-containing waste gases arise from the loading and unloading of tanks, vessels and containers (volume displacement), as well as from emergency venting. They are systematically collected and directed to the chlorine absorption unit [3, Euro Chlor 2011].

Chlorine and its compounds are included in Annex II to the Industrial Emissions Directive [77, Directive 2010/75/EU 2010].

3.4.4.2.3 Chlorine dioxide

Small amounts of chlorine dioxide originating from side reactions can be emitted from the chlorine absorption unit (Section 4.3.5.2). When measuring chlorine in the exhaust from the chlorine absorption unit, chlorine dioxide is usually included in the analytical result (Section 4.3.3.4) [67, Euro Chlor 2010].

Three plants reported chlorine dioxide concentrations in untreated waste gas from the chlorine absorption unit amounting to 9–22 mg/m³, 2–6 mg/m³, and up to approximately 40 mg/m³. Emission concentrations largely depend on the concentration of non-condensable gases, such as nitrogen and oxygen. Chlorine dioxide can be removed to concentrations below 0.4 mg/m³ by using hydrogen peroxide (Section 4.3.5.2) [68, AkzoNobel 2007], [185, InfoMil 2011].

Chlorine and its compounds are included in Annex II to the Industrial Emissions Directive [77, Directive 2010/75/EU 2010].

3.4.4.2.4 Carbon tetrachloride

In 2011, only three chlor-alkali plants in the EU-27 were using carbon tetrachloride. Two plants were using the substance only for the elimination of nitrogen trichloride (Section 2.6.6) and one plant was using it both for the elimination of nitrogen trichloride (Section 2.6.6) and the recovery of chlorine from tail gas (Section 2.6.8) [61, DG CLIMA 2012]. The other 71 chlor-alkali plants in the EU-27 and EFTA countries have a different layout for chlorine liquefaction and purification, which allows operation without carbon tetrachloride (Section 4.3.5.3).

Carbon tetrachloride for the elimination of nitrogen tetrachloride or the recovery of chlorine from tail gas is circulated in a closed loop. However, emissions may occur through leakages, and so the gas tightness of the system is of paramount importance to achieve low emission values [17, Dutch Ministry 1998]. In 2011, reported emissions ranged from 0 to 30 g CCl₄/t annual chlorine capacity, depending also on the frequency of use and the occurrence of accidents (Table 3.24).

Table 3.24: Emissions of carbon tetrachloride by chlor-alkali plants in the EU-27 in 2006 to 2011

Purpose	Emissions of carbon tetrachloride in g/t annual Cl ₂ capacity ⁽¹⁾					
	Year					
	2006	2007	2008	2009	2010	2011
Elimination of nitrogen trichloride ⁽²⁾	0.00 and 3.0	0.00 and 3.0	0.00 and 3.3	0.00 and 2.2	0.00 and 1.8	0.00 and 1.5
Recovery of chlorine from tail gas ⁽³⁾	0.15 and 10	0.20 and 6.5	0.18 and 4.4	0.93 and 4.4	4.0	30

⁽¹⁾ Annual average values, usually estimated/calculated.
⁽²⁾ Data from two plants.
⁽³⁾ Data from two plants from 2006 to 2009 and from one plant for 2010 to 2011.
Source: [61, DG CLIMA 2012]

3.4.4.2.5 Refrigerants

Refrigerants used for chlorine liquefaction are circulated in closed loops, but fugitive emissions may occur through leaks. Reported emission levels are shown in Table 3.25.

Table 3.25: Emissions of refrigerants by chlor-alkali plants in the EU-27 in 2008 to 2011

Refrigerant	Emissions in g/t chlorine produced ⁽¹⁾
HCFC-22 (R-22; chlorodifluoromethane) ⁽²⁾	1.3 and 2 and 2.31 and 38.6
HFC-134a (R-134A; 1,1,1,2-tetrafluoroethane) ⁽³⁾	2.06 and 8
R-410A (50.0 wt-% HFC-32, 50.0 wt-% HFC-125) ⁽⁴⁾	2.3
HFC (unspecified) ⁽⁴⁾	1.85

⁽¹⁾ Annual average values, usually estimated/calculated.
⁽²⁾ Data from four plants.
⁽³⁾ Data from two plants.
⁽⁴⁾ Data from one plant.
Source: [57, CAK TWG 2012]

The use of HCFCs such as HCFC-22 is generally prohibited, but reclaimed or recycled HCFCs may be used for the maintenance or servicing of existing refrigeration equipment until 31 December 2014 (Section 4.3.5.4) [78, Regulation EC/1005/2009 2009].

3.4.4.3 Emissions to water

Sulphuric acid mists coming from the drying towers are captured by candle filters and may be released as sulphates when the filters are washed for maintenance.

3.4.4.4 Generation of wastes

3.4.4.4.1 Spent sulphuric acid from chlorine drying

Concentrated sulphuric acid (92–98 wt-%) is used to dry chlorine (Section 2.6.5). Often the spent sulphuric acid is returned to the supplier for refortification. The spent acid can also be used to control pH in process and waste water streams or to destroy surplus hypochlorite, or it can be sold to a user who can accept this quality of acid. In rare cases, the spent acid becomes waste. Reported figures on the generation of sulphuric acid waste are summarised in Table 3.26.

Table 3.26: Generation of sulphuric acid waste in chlor-alkali plants in the EU-27 and EFTA countries in 2008 to 2011

Sulphuric acid waste in kg per tonne of chlorine produced, expressed as 100 % H ₂ SO ₄ ⁽¹⁾						
Min.	10th percentile	25th percentile	Median	75th percentile	90th percentile	Max.
0	0	0	0	0	0.25	12
⁽¹⁾ Annual average values. 39 data from 35 plants. 4 of these plants provided separate data for different electrolysis units. Source: [57, CAK TWG 2012]						

The consumption of sulphuric acid depends on the water concentration in the feed gas, the absorption temperature, and the original sulphuric acid concentration. Where it is possible to reconcentrate sulphuric acid in a closed loop, consumption is very low, close to 0.1 kg per tonne of chlorine produced [47, De Dietrich 2011]. Acid consumption can also be reduced by optimising the contact time between chlorine and acid, keeping the fresh acid concentration as high as possible and the spent acid concentration as low as possible.

3.4.4.4.2 Carbon tetrachloride

When carbon tetrachloride is used to absorb NCl₃ or to recover chlorine from tail gas, it needs to be replaced periodically because of the build-up of pollutants (bromine, FeCl₃, and chlorinated hydrocarbons, for example). The removed carbon tetrachloride is recycled, reclaimed or destroyed, in line with the provisions of the regulation on substances that deplete the ozone layer [78, Regulation EC/1005/2009 2009].

3.4.4.4.3 Bleach

During normal operation of a chlor-alkali plant, the bleach produced can be sold or used on site. When the bleach production unit needs to handle a large amount of chlorine in a short period of time (e.g. in the event of release of chlorine due to a malfunctioning of equipment), the bleach produced usually does not comply with the product specifications. In this case, the 'off-spec' bleach is either destroyed on site and discharged with the waste water, or is removed and processed elsewhere. Moreover, the regular bleach is also destroyed when there is insufficient on- or off-site demand, which is the case in some EU Member States.

3.4.5 Emissions and waste generation from sodium and potassium hydroxide processing

In diaphragm cell plants approximately four tonnes of water must be evaporated per tonne of 50 wt-% caustic soda solution produced, if this is the desired concentration. If sodium sulphate is not removed during the brine purification process, salt recovered from the evaporators is often recrystallised to avoid sulphate build-up in the brine. If the salt is recrystallised, the waste water will also contain sodium sulphates. Significant levels of copper may also be present in the waste water due to the corrosion of pipes and other equipment, along with iron and nickel which can dissolve to a certain extent from the stainless steel equipment. In addition, the presence of nickel may be related to the use of activated cathodes in the electrolytic cells. These metals are removed from the caustic by means of filtration and/or electrochemical reduction. The regeneration of the filters or the reduction cathodes generates an acid waste water flow which may contain iron and nickel at levels which might need further treatment. Reported emissions of sulphate and heavy metals from caustic processing in diaphragm cell plants are included in Sections 3.4.3.3.2 and 3.4.3.3.6, respectively.

Waste water from the caustic evaporators in membrane cell plants contains caustic soda solution and virtually no salt or sodium sulphates. It is usually recycled. In mercury cell plants, caustic soda leaving the decomposer already has a concentration of 50 wt-%.

The caustic solution is subsequently filtered. In membrane and diaphragm cell plants, the filters can be flushed with a weak acid solution, causing the iron hydroxide and other metal hydroxides to dissolve. The effluent is usually discharged, as most chlor-alkali plants have a physico-chemical waste water treatment unit which partially removes suspended solids and free chlorine.

In mercury cell plants, the caustic contains practically no salt impurities, but it does contain mercury. Normally, the caustic soda is filtered with activated carbon to remove mercury before handling. Emissions and waste generation related to this mercury removal are described in Sections 3.5.6.3.3 and 3.5.9.3, respectively.

3.4.6 Emissions from hydrogen processing

The hydrogen produced in all of the electrolytic processes contains small amounts of water vapour, sodium hydroxide and salt, which are removed through cooling and are recycled or treated with other waste water streams. However, in mercury cell plants the hydrogen leaving the decomposer is nearly saturated with mercury, which can lead to emissions to air, the emission levels depending on the treatment techniques used (Section 3.5.6.3.4).

On average, approximately 10 % of the hydrogen produced by chlor-alkali plants in the EU-27 and EFTA countries was emitted to the atmosphere in 2010 [8, Euro Chlor 2011]. For individual installations, the share of emitted hydrogen ranged from 0 % to approximately 53 % (Table 3.27). High shares of emitted hydrogen often concern isolated mercury cell plants, due to a lack of opportunities for hydrogen use (no customers and only limited need for steam) [3, Euro Chlor 2011].

Table 3.27: Share of hydrogen emitted by chlor-alkali plants in the EU-27 and EFTA countries in 2010

Share of hydrogen emitted ⁽¹⁾						
Min.	10th percentile	25th percentile	Median	75th percentile	90th percentile	Max.
0 %	0 %	2 %	9 %	18 %	36 %	53 %
⁽¹⁾ Data from 64 plants. Source: [186, Euro Chlor 2011]						

3.4.7 Emissions during other than normal operating conditions

3.4.7.1 Emissions during start-up and shutdown operations

Start-up and shutdown operations generally lead to increased hydrogen emissions. This is due to the fact that during plant shutdowns the relevant parts of the hydrogen network are flushed with nitrogen to prevent the formation of explosive gas mixtures. Therefore, the hydrogen produced during start-up usually does not have the required purity for its intended use [118, Solvay 2011].

Similarly, the chlorine produced during plant start-ups is usually of insufficient quality for its intended use and therefore it is completely transferred to the chlorine absorption unit. Some plants report slightly increased emissions of chlorine from the absorption unit during these start-up phases [118, Solvay 2011].

Chlor-alkali plants are typically shut down once per year for a period of one week to carry out maintenance activities. The start-up phase typically lasts one hour.

3.4.7.2 Emissions during incidents and accidents

Chlorine is classified as toxic [76, Regulation EC/1272/2008 2008]. If it is released, it can pose serious threats to the environment and human health. Chlor-alkali plants fall under the scope of the Seveso II and Seveso III Directives if chlorine is present in quantities equal to or in excess of 10 t. The Seveso II Directive is repealed with effect from 1 June 2015 [280, Seveso II Directive (96/82/EC) 1996], [338, Directive 2012/18/EU 2012].

Emissions from incidents and accidents are by nature discontinuous but may nevertheless contribute significantly to the overall emissions of a chlor-alkali plant. Fugitive emissions of chlorine and mercury are described in Sections 3.4.3.2 and 3.5.6, respectively. Some examples of incidents and accidents with chlorine on a larger scale are listed below.

- In 2009, some chlorine was released due to a defective gasket from a chlor-alkali plant in France [80, Engel 2011].
- In 2004, a major accident occurred in the Netherlands during scheduled maintenance. An infrared heater heated the liquid chlorine in an expansion pipe to more than 140 °C, causing a chlorine iron fire. Approximately 35 cm of the expansion pipe was burnt and 1500 l of liquid chlorine was released. No personal injuries were reported. South-easterly winds blew the cloud towards the harbour and the neighbouring town. A few people (both on site and in the harbour) reported minor irritation [81, eMARS 2011].
- In 2002, a large flood in the Czech Republic led to the inundation of the emergency retention sumps of a chlor-alkali plant in which the liquid chlorine storage tanks were located. The containers were lifted by the force of the floodwaters, which led to a burst in the piping and detachment of the tank socket. In total, 80.481 t of chlorine was released to the air and water. According to the results of air monitoring in the vicinity of the plant, the concentration of chlorine did not reach prescribed limits [81, eMARS 2011].

3.4.7.3 Emissions during decommissioning

No information provided.

3.4.8 Emissions of noise

Emissions of noise originate from equipment commonly used in the chemical sector and are therefore not specific to the chlor-alkali manufacturing industry. The major sources of noise emissions include [57, CAK TWG 2012]:

- trucks for unloading and loading (e.g. salt);
- transformers and rectifiers;
- pumps (e.g. brine circuit, cooling water);
- motors;
- control valves;
- punched disks;
- fans (e.g. cell room ventilation, hydrogen emission);
- compressors (e.g. chlorine, hydrogen, refrigerant);
- centrifuges (e.g. caustic evaporation unit, in the case of diaphragm cell plants);
- cooling machines;
- transport of media in pipelines and other systems without optimal dimensions;
- transport on and near the site including railways;
- cleaning of process equipment (e.g. mechanical cleaning of cells).

Reported noise emissions from chlor-alkali plants are shown in Table 3.28.

Table 3.28: Emissions of noise from chlor-alkali plants in the EU-27 and EFTA countries in 2008 to 2011

Origin of noise emission	Measurement point	Noise level in dB
Entire plant	Outside the site boundaries	32–35 ⁽¹⁾ 41–48 ⁽²⁾
Rectifier and transformer	NI	78.2
Salt storage	Conveyor	85.1–95.7
Brine filtration	NI	76.1
Brine pump	NI	76.7–89.6
Brine agitator	NI	83.4–83.9
Cell room	Between electrolyzers inside building	80.5
	Roof	64.0
	Ground floor, outside building	77.5
Chlorine compression	Window	71.5
	Inside closed building	≤ 85
		92.1 93
Hydrogen compression	Inside building	88
		90
Air compression	Inside closed building	70.4
Sodium hydroxide concentration pumps	NI	88
Centrifuge in caustic evaporation unit	Inside closed building	86.0
Sulphate drying	Inside closed building	74.6
Mercury distillation	Window	74.4–86.7
Pump station cooling towers	Inside closed building	92.4
⁽¹⁾ Emission limit value during the night 40 dB(A). ⁽²⁾ Day and night measurements lasting 30 minutes. NB: NI = No information provided. Source: [57, CAK TWG 2012]		

Directive 2002/49/EC relates to the assessment and management of environmental noise [148, Directive 2002/49/EC 2002], while Directive 2003/10/EC sets exposure limit and exposure action values for workers' protection against noise [149, Directive 2003/10/EC 2003].

3.5 Emission and consumption levels and waste generation from mercury cell plants

3.5.1 Overview

Emissions and consumption of mercury, as well as the generation of mercury-contaminated waste, are specific to the mercury cell technique. Mercury is contained and recycled within the chemical process. Nevertheless, due to the process characteristics, mercury emissions to air and water occur and some mercury leaves the process via waste. Products, mainly caustic soda, and to a lesser extent hydrogen, contain certain amounts of mercury and are treated before being used or sold. As regards the mercury level in chlorine, it is virtually zero and no mercury removal processes are used for this product. Some emissions occur during the decommissioning of an installation or its conversion to the membrane cell technique.

Any attempt to draw a balance generally results in a difference between inputs and outputs of mercury, either positive or negative. This issue is specifically addressed in Section 3.5.10.

3.5.2 Mercury in cells

As of January 2013, the total chlorine production capacity in the EU-27 and EFTA countries based on the mercury cell technique amounted to 3.27 Mt/yr [9, Euro Chlor 2013]. As of December 2012, a total of 6 053 t of metallic mercury were contained in cells and another 1 005 t were stored in facilities on site, either as stock for further use or as waste after the respective mercury cell unit had ceased to operate (Table 3.29) [82, Euro Chlor 2013].

Table 3.29: Amounts of metallic mercury on sites of mercury cell plants in the EU-27 and EFTA countries in December 2012

Euro Chlor No.	Country	Company	Site	Chlorine production capacity in kt/yr	Mercury used in cells in t	Mercury stored in facility in t	Total mercury on site in t	Mercury in cells in kg Hg/t annual chlorine capacity
3	BE	Solvina	Antwerp-Lillo	180 (¹)	260.92	9.87	270.79	1.45
3	BE	Solvina	Antwerp-Zandvliet	110	184.91	8.70	193.61	1.68
5	BE	INEOS ChlorVinyls	Tessenderlo	205	282.50	0.00	282.50	1.38
6	CZ	Spolana	Neratovice	135	214.47	0.75	215.22	1.59
7	CZ	Spolchemie	Ústí nad Labem	61	133.47	17.96	151.43	2.19
8	FI	AkzoNobel	Oulu	40	53.65	0.60	54.25	1.34
10	FR	PPChemicals	Thann	72	124.51	20.66	145.16	1.73
13	FR	Arkema	Jarrie	73	176.27	33.50	209.77	2.41
14	FR	Kem One	Lavéra	166	274.00	24.00	298.00	1.65
17	FR	PC Harbonnières	Harbonnières	23	26.25	0.04	26.29	1.14
18	FR	Solvay	Tavaux	240 (¹)	106.77	403.04	509.81	0.44
19	FR	PC Loos	Loos	18	40.40	1.73	42.13	2.24
20	DE	BASF	Ludwigshafen	170	733.77	72.20	805.97	2.72
23	DE	Bayer Material Science	Uerdingen	130 (¹)	0.00	67.80	67.80	NA
29	DE	AkzoNobel	Ibbenbüren	125	175.66	0.00	175.66	1.41
31	DE	Evonik Industries	Lülsdorf	137	351.75	36.99	388.74	2.57
32	DE	INEOS ChlorVinyls	Wilhelmshaven	149	175.50	3.00	178.50	1.18
33	DE	AkzoNobel	Frankfurt	167	238.00	33.00	271.00	1.43
38	EL	Hellenic Petroleum	Thessaloniki	40	47.12	0.00	47.12	1.18
39	HU	Borsodchem	Kazincbarcika	131	214.49	13.05	227.54	1.64
50	IT	Tessenderlo Chemie	Pieve Vergonte	42	79.23	0.00	79.23	1.89
58	PL	PCC Rokita	Brzeg Dolny	77	280.74	0.46	281.20	3.65
63	SK	Fortischem	Nováky	76	101.50	0.00	101.50	1.34
64	ES	Ercros	Palos de la Frontera	48	72.52	6.38	78.90	1.51
66	ES	Ercros	Vilaseca	135	208.19	0.00	208.19	1.54
68	ES	Elnosa	Lourizán	34	65.68	1.95	67.63	1.93
69	ES	Ercros	Flix	115	336.68	0.00	336.68	2.93
70	ES	Química del Cinca	Monzón	31	55.60	3.41	59.02	1.79
71	ES	Hispanic	Martorell	218	249.98	10.01	260.00	1.15

Euro Chlor No.	Country	Company	Site	Chlorine production capacity in kt/yr	Mercury used in cells in t	Mercury stored in facility in t	Total mercury on site in t	Mercury in cells in kg Hg/t annual chlorine capacity	
72	ES	Solvay	Torrelavega	63	122.94	1.38	124.32	1.95	
75	SE	INEOS ChlorVinyls	Stenungsund	120	157.32	8.34	165.66	1.31	
77	CH	CABB	Pratteln	27	NI	NI	NI	NI	
82	UK	INEOS ChlorVinyls	Runcorn	277	357.53	222.48	580.01	1.29	
91	RO	Oltchim	Râmnicu Vâlcea	186	151.00	4.00	155.00	0.81	
All plants					6 053	1 005	7 058	Minimum	0.44
								10th percentile	1.15
								25th percentile	1.32
								Median	1.57
								Average	1.70
								75th percentile	2.13
								90th percentile	2.74
								Maximum	3.65
<p>(¹) Plant was converted into a membrane cell plant in 2012. NB: NA = not applicable; NI = no information provided. Source: [9, Euro Chlor 2013], [82, Euro Chlor 2013]</p>									

3.5.3 Reporting of figures per chlorine capacity

With regards to mercury outputs, figures are expressed and reported by the industry in terms of chlorine capacity rather than real production. This is quite specific to the mercury cell chlor-alkali sector. Due to the nature of the electrolytic process, mercury emissions are not linked to production in a linear way. The majority of the emissions are from the cell room, where the absolute amount mainly depends on small leaks or accidental losses and on historical contamination of the building, which are mostly independent from the production rate. The emissions are far more dependent on the equipment, plant design, maintenance requirements, pressure and temperature of the cell and decomposer [83, Euro Chlor 2010].

However, it could be assumed that if half of the cells are switched off, the reporting of figures per chlorine capacity may be inappropriate. The industry gives two main reasons to argue that this is usually not the case. The first one is economic and the second technical. For economic reasons, a plant will always prefer to run all its cells because it is the cheapest way of operating and minimising costs. This is particularly true in countries like Spain or the United Kingdom where electricity tariffs can vary a lot during the year or even the day. Running at lower current densities is cheaper than switching off some cells. The second reason given is the design of the electrical circuit. The rectifier is specified for a certain voltage and the electrical equipment may not support a voltage drop, especially for plants using a combination of diaphragm and mercury cell techniques or mercury and membrane cell techniques.

The industry also reports that production figures on a plant by plant basis are confidential data for 'competitiveness reasons'.

Contrary to what is described above, a minor share of the mercury emissions is indeed dependent on the production rate. For example, emissions via products or via the brine purge are directly linked to production [83, Euro Chlor 2010]. In addition, maintenance frequencies and related emissions also increase with current densities and thus production rates.

The emissions of pollutants other than mercury depend mainly on the production rate and should thus preferably be expressed per actual production.

3.5.4 Consumption of mercury

Reported consumption of mercury ranges from 2.6 to 10.9 g/t annual chlorine capacity [75, COM 2001].

3.5.5 Overall mercury emissions and waste generation

Mercury emissions and waste generation from individual chlor-alkali plants in the EU-27 and EFTA countries in 2013 are summarised in Table 3.30. These figures will be discussed in more detail in the subsequent sections.

Figure 3.4 shows the weighted averages of the total emissions from all chlor-alkali plants in Western Europe (OSPAR countries) from 1977 to 1998 and Figure 3.5 for the EU-27 and EFTA countries from 1995 to 2013. For the OSPAR countries, emissions decreased by approximately 92 % from 1977 to 1995, while for the EU-27 and EFTA countries, emissions decreased by approximately 74 % from 1995 to 2013. The observed decreases are due to reduced emissions from individual installations. However, the weighted average may also be influenced by the shutdown or inclusion of installations with emissions higher or lower than the average. For example, the slight increase from 2008 to 2009 is caused by a plant with high mercury emissions to water, which in 2009 was included for the first time in the calculations. Otherwise, the weighted average of the total emissions would have decreased to 0.81 g Hg/t annual chlorine capacity.

The reported figures for mercury emissions and for mercury in waste disposed of are subject to some uncertainty, which is due to several factors, such as [97, Concorde 2006]:

- the diffuse nature of the majority of mercury emissions to air;
- the temporal variations of these diffuse emissions;
- the inhomogeneous nature of mercury-contaminated waste;
- the measurement uncertainty related to the monitoring technique;
- the uncertainty related to the measurement of the airflow in the cell room;
- the differences in applied monitoring techniques.

Almost all available data concerning emissions of mercury from mercury cell plants are provided by industry. These data are widely accepted by national authorities and international organisations such as OSPAR and UNEP. Although in some EU Member States regular inspections take place, these emission data are usually not published. Apart from this, some emission data were obtained by research projects.

One example is the EU-funded project EMECAP (European Mercury Emission from Chlor-Alkali Plants) which in 2002/2003 performed a total of six weekly measurement campaigns at three mercury cell plants: the AkzoNobel plant in Bohus (Sweden), chlorine capacity 100 kt/yr; the Solvay plant in Rosignano (Italy), chlorine capacity 125 kt/yr; and the Zakłady Azotowe plant in Tarnów (Poland), chlorine capacity 43 kt/yr (plant capacities as reported by [107, Euro Chlor 2006]). The study showed large differences in the mercury emissions to air measured in winter or summer and at the different plants. Moreover, mercury emissions were found to be strongly dependent on the wind speed. The average values for total mercury emissions to air ranged from 6 g/h during the winter campaign at the Swedish plant to 54 g/h during the summer campaign at the Italian plant [100, Grönlund et al. 2005], [102, EMECAP 2004]. The emissions are summarised in Table 3.31 and compared to data provided by Euro Chlor.

Table 3.30: Mercury emissions from individual mercury cell plants in 2013

Euro Chlor No.	Country	Company	Site	Relevant chlorine production capacity in kt/yr ⁽¹⁾	Emissions via products in g Hg/t annual chlorine capacity	Emissions to water in g Hg/t annual chlorine capacity	Emissions to air in g Hg/t annual chlorine capacity	Mercury in waste disposed of in g Hg/t annual chlorine capacity	Total emissions (products + water + air) in g Hg/t annual chlorine capacity
3	BE	Solvin	Antwerp-Zandvliet	110	0.02	0.01	0.43	0.03	0.46
5	BE	INEOS ChlorVinyls	Tessenderlo	205	0.02	0.01	0.61	1	0.64
6	CZ	Spolana	Neratovice	135	0.08	0.13	0.32	0.87	0.53
7	CZ	Spolchemie	Ústí nad Labem	61	0.04	0.13	0.55	10.3	0.72
8	FI	AkzoNobel	Oulu	40	0.06	0.04	1.12	0	1.22
10	FR	PPChemicals	Thann	72	0.07	0.02	0.8	194.35	0.89
13	FR	Arkema	Jarrie	101	0.01	0.25	0.48	0.05	0.74
14	FR	Kem One	Lavéra	166	0.04	0.09	0.51	0.03	0.64
17	FR	PC Harbonnières	Harbonnières	23	0.15	0	0.75	36.04	0.90
19	FR	PC Loos	Loos	18	0.13	0.06	0.68	0.23	0.87
20	DE	BASF	Ludwigshafen	170	0.03	0.01	0.6	128.67	0.64
29	DE	AkzoNobel	Ibbenbüren	125	0.05	0	0.41	0.14	0.46
31	DE	Evonik Industries	Lülsdorf	137	0.06	0.07	0.5	24.72	0.63
32	DE	INEOS ChlorVinyls	Wilhelmshaven	81	0.02	0	0.39	29.37	0.41
33	DE	AkzoNobel	Frankfurt	167	0.08	0.02	0.8	0	0.90
38	EL	Hellenic Petroleum	Thessaloniki	37	0.14	0.03	0.25	3.45	0.42
39	HU	Borsodchem	Kazincbarcika	131	0.11	0.06	0.62	0.01	0.79
50	IT	Tessenderlo Chemie	Pieve Vergonte	42	0.1	0	0.5	2.35	0.60
58	PL	PCC Rokita	Brzeg Dolny	78 ⁽²⁾	0.11 ⁽²⁾	0.82 ⁽²⁾	0.74 ⁽²⁾	12.74 ⁽²⁾	1.67 ⁽²⁾
63	SK	Fortischem	Nováky	NI	NI	NI	NI	NI	NI
64	ES	Ercros	Palos de la Frontera	47	0.02	0.01	0.4	16.43	0.43
66	ES	Ercros	Vilaseca	135	0.03	0.06	0.41	15.75	0.50
68	ES	Elnosa	Lourizán	34	0.06	0.01	0.4	10.75	0.47
69	ES	Ercros	Flix	88	0.02	0.02	0.3	11.49	0.34
70	ES	Química del Cinca	Monzón	31	0.1	0.01	0.61	36.64	0.72
71	ES	Hispanic	Martorell	218	0.04	0.03	0.36	4.25	0.43
72	ES	Solvay	Torrelavega	63	0.11	0.05	0.42	3.35	0.58
75	SE	INEOS ChlorVinyls	Stenungsund	120	0.01	0	0.14	0	0.15

Euro Chlor No.	Country	Company	Site	Relevant chlorine production capacity in kt/yr ⁽¹⁾	Emissions via products in g Hg/t annual chlorine capacity	Emissions to water in g Hg/t annual chlorine capacity	Emissions to air in g Hg/t annual chlorine capacity	Mercury in waste disposed of in g Hg/t annual chlorine capacity	Total emissions (products + water + air) in g Hg/t annual chlorine capacity
77	CH	CABB	Pratteln	27	0.08	0.07	0.64	30.85	0.79
82	UK	INEOS ChlorVinyls	Runcorn	277	0.05	0.05	1.1	18.12	1.20
91	RO	Oltchim	Râmnicu Vâlcea	NA ⁽³⁾	NA	NA	NA	NA	NA
All plants				Minimum	0.01	0.00	0.14	0.00	0.15
				10th percentile	0.02	0.00	0.32	0.01	0.42
				25th percentile	0.03	0.01	0.40	0.14	0.46
				Median	0.06	0.03	0.50	4.25	0.64
				75th percentile	0.10	0.06	0.64	18.12	0.79
				90th percentile	0.11	0.13	0.80	36.16	0.96
				Maximum	0.15	0.82	1.12	194.35	1.67
				Weighted average ⁽⁴⁾	0.05	0.07	0.56	19.42	0.68

⁽¹⁾ The capacities may differ from those in Table 8.1 (e.g. when not all mercury cells were used).
⁽²⁾ Data from 2010.
⁽³⁾ The mercury cell electrolysis unit was not in operation in 2013.
⁽⁴⁾ Weighting by the annual chlorine production capacity.
NB: NA = not applicable; NI = no information provided.
Source: [55, Euro Chlor 2014]

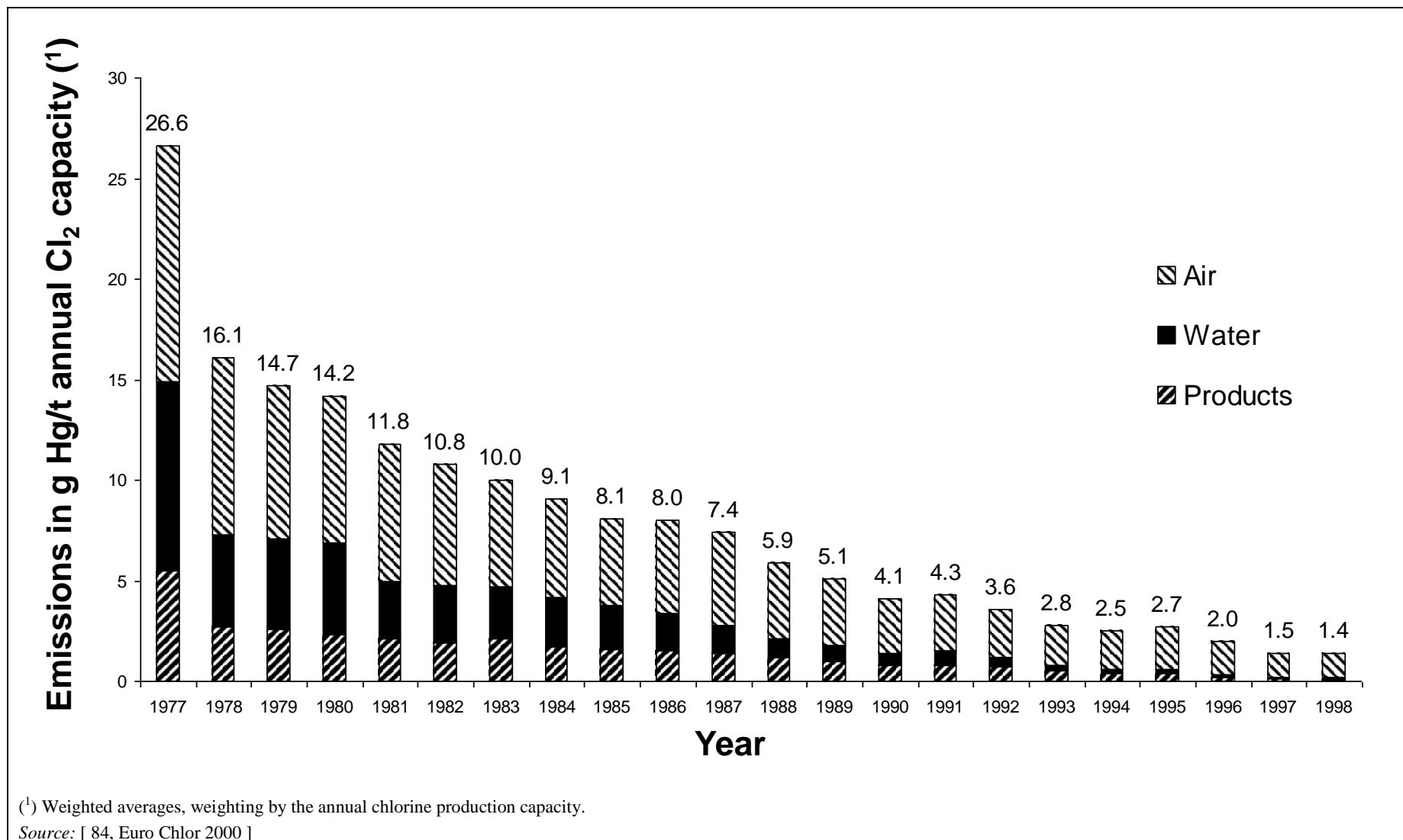

Figure 3.4: Trend of mercury emissions from mercury cell plants in Western Europe (OSPAR countries) from 1977 to 1998

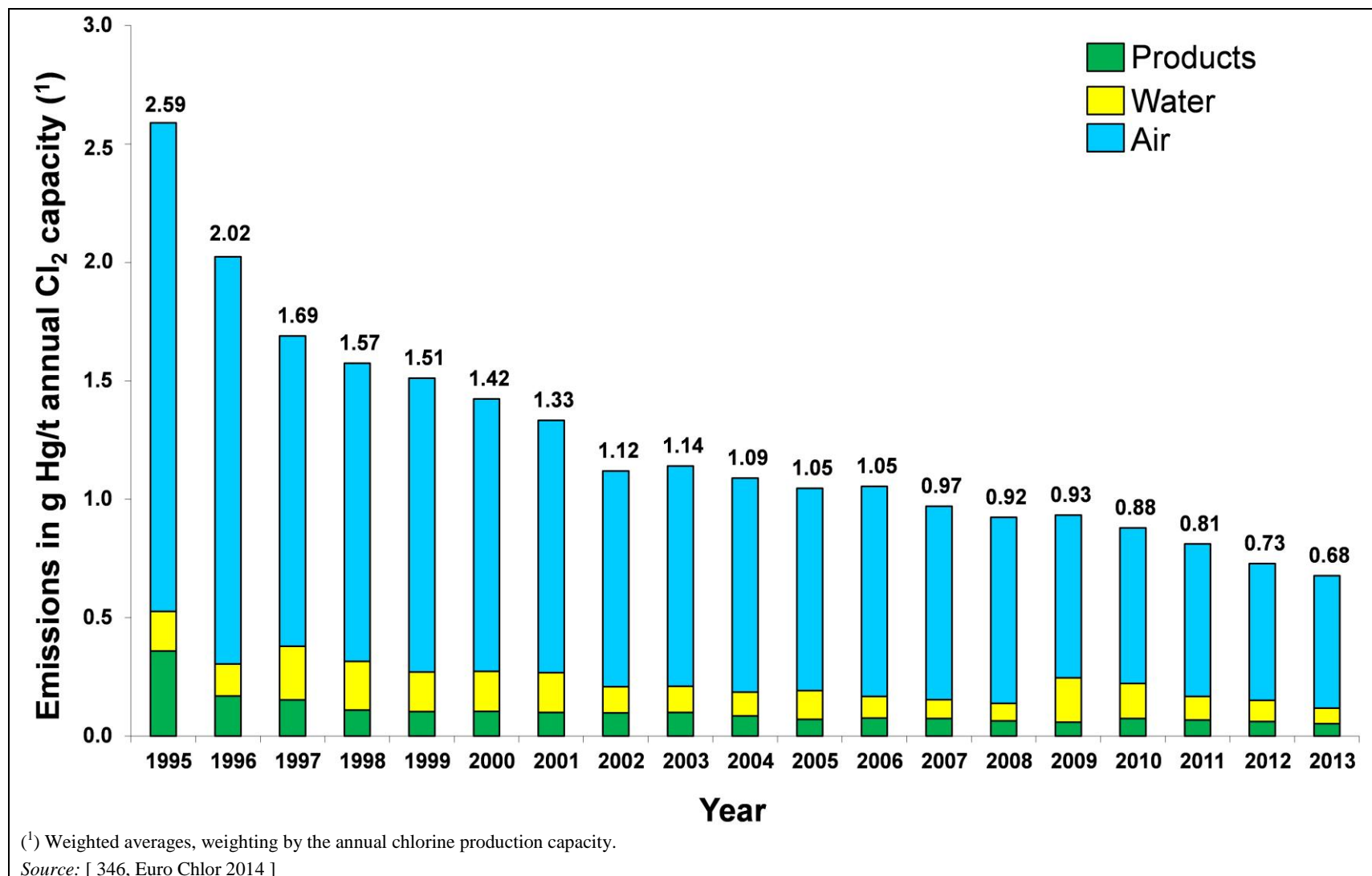

Figure 3.5: Trend of mercury emissions from mercury cell plants in the EU-27 and EFTA countries from 1995 to 2013

Table 3.31: Mercury emission data from the EMECAP project and Euro Chlor for three mercury cell plants in 2002/2003

Plant	Chlorine production capacity ⁽¹⁾	Total mercury emissions to air					
		EMECAP project				Euro Chlor	
	In kt/yr	g/h ⁽²⁾ ⁽³⁾		g/t annual chlorine capacity ⁽³⁾ ⁽⁴⁾		g/t annual chlorine capacity ⁽⁵⁾	
		January to February 2002	June to August 2003	January to February 2002	June to August 2003	Annual average 2002	Annual average 2003
Eka Nobel, Bohus (Sweden)	100	6	11	0.5	0.96	0.23	0.20
Solvay, Rosignano (Italy)	125	20	54	1.4	3.8	0.67	0.41
Zakłady Azotowe, Tarnów (Poland)	43	NI	28	NI	5.7	NI	NI

⁽¹⁾ Data taken from [107, Euro Chlor 2006].
⁽²⁾ Data taken from [102, EMECAP 2004].
⁽³⁾ Data refer to the average of measurements conducted over one week.
⁽⁴⁾ Data calculated using the emission data from [102, EMECAP 2004] and the annual chlorine production capacity data from [107, Euro Chlor 2006].
⁽⁵⁾ Data provided by Euro Chlor and reported in [97, Concorde 2006].
 NB: NI = no information provided.

As can be seen, total mercury emissions to air as reported by the EMECAP project are approximately a factor of two to nine times higher than those reported by Euro Chlor. The reasons for these discrepancies are unclear. They might result from the differences in the monitoring techniques used, the measurement uncertainty or from the fact that the EMECAP figures refer to short-term measurement campaigns of one week while the Euro Chlor figures refer to annual averages.

The results of two more independent studies on mercury emissions from the cell room are described in Section 3.5.6.2. Moreover, other studies were carried out on mercury concentrations in ambient air in the vicinity of mercury cell plants [95, EEB 2008], [102, EMECAP 2004], but it is impossible to derive emission data from these measurements.

3.5.6 Emissions to air

3.5.6.1 Overview

The emissions to air specific to mercury cell plants relate to mercury. Other emissions are described in Section 3.4 covering emissions and waste generation relevant to all three cell techniques. Emission sources include the cell room ventilation (Section 3.5.6.2) and process exhausts (Section 3.5.6.3).

The reported overall emission loads of mercury to air from installations in the EU-27 and EFTA countries in 2013 range from 0.14 to 1.12 g/t annual chlorine capacity, the median being 0.50 g/t annual chlorine capacity (Table 3.30).

3.5.6.2 Cell room ventilation

3.5.6.2.1 Emission levels

Ventilation air from the cell room is usually the main source of mercury emissions to air, and emissions from this source can be ten times higher than from process exhaust. The cell room with the hot mercury cells (approximately 80 °C) is usually ventilated by means of natural ventilation. The heat produced during electrolysis requires the air to be changed 10–25 times per hour, depending on the type of building [1, Ullmann's 2006]. Ventilation airflows in the range of 20000–120000 m³/tonne annual chlorine capacity were found. This corresponds to total ventilation airflows between 300000 and 2 000000 m³/h, depending on the weather conditions, season, design and size of the plant [17, Dutch Ministry 1998]. Due to this huge volume and the fact that the ventilation flow escapes to the atmosphere from many points, mercury removal techniques are not used [87, Euro Chlor 2006].

Reported emissions of mercury from the cell room are summarised in Table 3.32. The two installations with the lowest emission loads in OSPAR countries report mercury concentrations of 2 and 1.73–4.90 µg/m³ in cell room ventilation air, and emission loads of 0.132 and 0.247 g/t annual chlorine capacity, respectively [57, CAK TWG 2012]. Directive 2009/161/EU sets an indicative occupational exposure limit value of 20 µg/m³ (at 20 °C and 101.3 kPa) measured or calculated in relation to a reference period of an eight-hour time-weighted average [88, Directive 2009/161/EU 2009].

Table 3.32: Emissions of mercury to air from the cell room from mercury cell plants in the EU-27 and EFTA countries in 2008/2009

Mercury concentrations in cell room ventilation air in µg/m ³ ⁽¹⁾ ⁽²⁾ ⁽³⁾							
Value reported ⁽⁴⁾	Min.	10th percentile	25th percentile	Median	75th percentile	90th percentile	Max.
Min. ⁽⁵⁾	0.70	0.70	1.0	1.8	7.4	12	19
Max. ⁽⁶⁾	4.9	10	17	30	42	50	140
Average ⁽⁷⁾	2 and 22						
Mercury emission loads from cell room ventilation air in g per tonne of annual chlorine capacity ⁽⁸⁾							
Value reported ⁽⁴⁾	Min.	10th percentile	25th percentile	Median	75th percentile	90th percentile	Max.
Average ⁽⁹⁾	0.132	0.367	0.425	0.587	0.860	1.01	1.29
⁽¹⁾ Data refer to plants in the EU-27 and EFTA countries in 2008/2009 [57, CAK TWG 2012]. ⁽²⁾ Data refer to standard conditions (273.15 K, 101.3 kPa) after deduction of the water content. ⁽³⁾ Most reporting plants perform periodic measurements (mostly weekly) and some perform continuous measurements. Averaging periods reported were mostly daily and weekly. ⁽⁴⁾ Some plants reported ranges with minimum and maximum values and some reported average values. ⁽⁵⁾ 10 data from 10 plants. In addition, 1 plant reported a value below the detection limit. ⁽⁶⁾ 11 data from 11 plants. ⁽⁷⁾ 2 data from 2 plants. ⁽⁸⁾ Data refer to plants in OSPAR countries in 2009 [85, Euro Chlor 2011]. ⁽⁹⁾ 29 data from 29 plants. Source: [57, CAK TWG 2012], [85, Euro Chlor 2011]							

In the United States, two independent studies were carried out in 2000 and 2005/2006. During February 2000, diffuse mercury emissions from the Olin chlor-alkali plant located in Augusta, Georgia were measured during a nine day period. The authors of the study concluded that diffuse air emissions from the cell room roof vent are episodic and vary with plant operating conditions (maintenance and minor operational perturbations) [98, Southworth et al. 2004]. Most of the mercury emissions occurred as elemental gaseous mercury, although approximately 2 % were in the form of divalent gaseous mercury, such as HgCl₂ [106, Landis et al. 2004]. The daily averages of elemental mercury emissions from the roof vent ranged from 370 to 660 g/d, during a measurement period of seven days with an average elemental mercury

emission of 470 g/d. The latter is equivalent to mercury emissions of 1.52 g/t annual chlorine capacity (plant capacity 309 t/d, equivalent to 113 kt/yr) [99, Kinsey et al. 2004].

In 2005/2006, the United States Environmental Protection Agency conducted another study at three mercury cell plants with the aim of obtaining data over a number of months under a wide range of operating conditions and during times when all major types of maintenance activities were conducted. The study revealed that maintenance activities and alarm events can result in short-term spikes in emissions but the analyses of the data did not show any correlation between daily diffuse mercury emissions and these events. The only factor which showed any correlation to daily emissions, albeit weak, was the ambient temperature. Furthermore, diffuse sources outside the cell room did not contribute measurable mercury emissions when compared to diffuse emissions from the cell room [101, US EPA 2008]. Reported emission data from the study are summarised in Table 3.33.

Table 3.33: Fugitive mercury emissions from the cell room from three mercury cell plants in the United States in 2005/2006

Plant	Chlorine production capacity In kt/yr	Fugitive mercury emissions from the cell room to air					
		g/d			g/t annual chlorine capacity		
		Min.	Average	Max.	Min.	Average	Max.
Olin in Charleston, Tennessee (United States) ⁽¹⁾	260	99	499	1 256	0.14	0.70	1.76
OxyChem in Muscle Shoals, Alabama (United States) ⁽²⁾	154	150	470	1 300	0.36	1.11	3.08
OxyChem in Delaware City, Delaware (United States) ⁽³⁾	81	19	421	1 100	0.09	1.90	4.96

⁽¹⁾ Daily average values obtained during the period of August to October 2006.
⁽²⁾ Daily average values obtained during the period of August 2005 to January 2006.
⁽³⁾ Daily average values obtained during the period of April to November 2005.
Source: [104, US EPA 2008], [105, US EPA 2007]

The reported average emission loads for the Olin plant in Charleston and the OxyChem plant in Muscle Shoals are higher than the median of the plants in OSPAR countries in 2009, but lower than the maximum emission load reported for the latter (Table 3.32 and Table 3.33). However, the emission load of the OxyChem plant in Delaware City exceeds the maximum emission load reported for plants in OSPAR countries.

In 2011, the United States Environmental Protection Agency noted that mercury cell plants with continuous monitoring systems and methods to estimate the flowrates had reported lower diffuse mercury emissions compared to the 2005/2006 study, averaging around 225 g/d in 2008 [103, US EPA 2011].

3.5.6.2.2 Influencing factors

Mercury emissions from the cell room are influenced by a number of factors including [87, Euro Chlor 2006], [116, Euro Chlor 2013]:

- number and area of the cells;
- design of the cells (e.g. leak tightness, type of decomposer (horizontal or vertical));

- layout of the cell room (e.g. number of floors, accessibility, construction materials, ventilation airflow direction);
- current density and distribution;
- production rate;
- brine quality;
- salt (NaCl or KCl);
- anode lifetime;
- season and climate.

For example, cell rooms with a forced downflow of ventilation air show higher temperatures below the cells, leading to higher evaporation rates of any spilled mercury. Usually, ventilation air flows upward due to the buoyancy effect [299, INEOS Runcorn 2012].

The electrolysis of KCl is more sensitive to trace impurities and it is therefore necessary to open the cells more frequently for maintenance and cleaning. As a consequence, mercury emissions from a cell room in which KCl is used are higher than if NaCl were used in the same cell room [42, Euro Chlor 2010]. However, emissions also depend on other plant-specific factors and several plants in the EU-27 and EFTA countries using exclusively NaCl show higher emissions to air than those of plants using KCl [55, Euro Chlor 2014].

The effect of season and climate on mercury emissions from the cell room is generally accepted. However, this applies only to mercury that is already present in the cell room, while leakage from the cells is assumed not to depend on the ambient temperature [17, Dutch Ministry 1998].

Mercury spillage can occur during essential operations involving cells or decomposers, such as opening the cells for anode changing or cleaning, assembling or dismantling equipment, or replacing defective pipes. Optimisation by keeping the cells closed as much as possible reduces the emissions due to maintenance operations [89, Euro Chlor 2004]. The existence of a maintenance plan has been shown to increase the lifetime of cells sixfold and reduce the frequency of opening to only once every two or three years

Mercury emissions are also significantly reduced by good housekeeping practices which are backed up by employees with the motivation to work in such a way [89, Euro Chlor 2004]. The lowest values of mercury emissions have been observed in companies which have a specific and stringent cleaning and housekeeping programme.

Another source of emissions to air is the evaporation of mercury deposited in the equipment and in the building, for instance in cracks in the floor and in porous concrete and bricks [87, Euro Chlor 2006].

3.5.6.3 Process exhaust

3.5.6.3.1 Overview

Process exhaust refers to all gaseous streams by which mercury can be emitted to the atmosphere, apart from cell room ventilation air and hydrogen as product. The typical streams which may have a significant mercury content that requires the use of a treatment technique include [87, Euro Chlor 2006]:

- purge air from cell end-boxes;
- vents from wash water collection tanks;
- exhaust from any vacuum system used to collect spilled mercury (but some portable vacuum cleaners have their own mercury absorption system);
- hydrogen burnt or sold as a fuel (Section 3.5.6.3.4);
- hydrogen emitted to the atmosphere (Section 3.5.6.3.4);

- vents from caustic soda pumping tanks (Section 3.5.6.3.3);
- vents from caustic soda filters (Section 3.5.6.3.3);
- exhausts and vents from distillation units for mercury-contaminated solid wastes (Section 3.5.6.3.6);
- vents from the storage of metallic mercury and waste contaminated with mercury (Section 3.5.6.3.5);
- vents from workshops where contaminated equipment is handled (Section 3.5.6.3.7).

Some streams may be combined prior to treatment while others require separate treatment units. For example, hydrogen streams are usually not mixed with streams containing significant amounts of air, in order to prevent the formation of explosive mixtures [87, Euro Chlor 2006].

Other streams are likely to contain some mercury, but in such low concentrations that they do not require treatment [87, Euro Chlor 2006]:

- vents from brine saturators (Section 3.5.6.3.2);
- vents from brine filters and treatment tanks (Section 3.5.6.3.2);
- vents from caustic soda stock tanks.

Mercury is mainly removed by (Section 8.2.3.1) [1, Ullmann's 2006], [87, Euro Chlor 2006]:

- adsorption on iodised or sulphurised activated carbon;
- scrubbing with hypochlorite or chlorinated brine to form mercury(II) chloride;
- adding chlorine to form dimercury dichloride (calomel) which is collected on a solid substrate such as rock salt in a packed column.

The liquid or solid obtained by using the first two options mentioned above can be recycled to the brine, while the solid obtained with the last option may be disposed of in landfills/salt mines or treated in the mercury retorting unit (Section 3.5.9.7) [3, Euro Chlor 2011].

One plant reports mercury concentrations of 1–49 µg/m³ after air treatment (hydrogen not included), while another plant reports concentrations from below the detection limit to 65 µg/m³ after filtering (hydrogen, mercury retorting and workshop ventilation not included) [57, CAK TWG 2012].

Reported emission loads of mercury from process exhausts are summarised in Table 3.34.

Table 3.34: Mercury emissions to air from process exhausts from chlor-alkali plants in OSPAR countries in 2009

Mercury emission loads from process exhausts in g per tonne of annual chlorine capacity ⁽¹⁾							
Value reported	Min.	10th percentile	25th percentile	Median	75th percentile	90th percentile	Max.
Average ⁽²⁾	0.000 30	0.002 0	0.002 8	0.006 5	0.029	0.057	0.180
⁽¹⁾ Data refer to plants in OSPAR countries in 2009. ⁽²⁾ 24 data from 24 plants. In addition, 5 plants reported values below the detection limit. <i>Source:</i> [85, Euro Chlor 2011]							

3.5.6.3.2 Vents from the brine system

Mercury may be released in vapours from brine systems if the presence of oxidising species is not maintained. Depleted brine from mercury cells normally contains up to 25 ppm of mercury in its oxidised form (as HgCl₃⁻ and HgCl₄²⁻). It is maintained in this form by controlling the dechlorination unit, leaving a residual oxidising environment which largely prevents metallic mercury from being formed and emitted to the atmosphere from salt solvers, brine

resaturators or brine filters and treatment vessels. For example, the stirring air from precipitation tanks or the vapour from resaturation units usually has mercury concentrations below $10 \mu\text{g}/\text{m}^3$ [86, Euro Chlor 2010].

3.5.6.3.3 Vents from caustic processing

Mercury contained in the caustic soda after the decomposer (in the range of 2.5 to 25 mg/l) could be emitted from the vents from pumping tanks or from the vents from caustic filters, depending on the type of decomposer (vertical ones have a very low flow) and temperature, and so these vents are usually connected to a gas treatment unit.

When solid caustic soda or potash (100 %) is required, the 50 wt-% solution has to be concentrated in a caustic evaporator after mercury filtration. The residual mercury (10–100 $\mu\text{g Hg}/\text{kg NaOH}$ (100 %), corresponding to 0.011–0.11 g/t annual chlorine capacity), then evaporates from the caustic as a result of the heat treatment in the caustic evaporator [17, Dutch Ministry 1998].

3.5.6.3.4 Burnt or emitted hydrogen

Mercury emissions from hydrogen which is emitted or burnt/sold as a fuel are included in the figures for the overall mercury emissions to air [86, Euro Chlor 2010], [90, PARCOM Decision 90/3 1990]. If the hydrogen is used for other purposes, then the related emissions of mercury are described in Section 3.5.8 on emissions via products.

Hydrogen is formed from the exothermic reaction of sodium amalgam with water. It is referred to as 'strong hydrogen', indicating its high concentration [39, HMSO 1993]. The hydrogen gas stream is nearly saturated with mercury when it leaves the decomposer at a temperature of 90–130 °C. The saturation concentration of mercury in the gas phase is $0.836 \text{ g}/\text{m}^3$ at 80 °C and $2.40 \text{ g}/\text{m}^3$ at 100 °C [1, Ullmann's 2006]. This mercury is generally removed in a multi-stage process (Section 8.2.3.2)

One plant reports mercury concentrations of 1–185 $\mu\text{g}/\text{m}^3$ in treated hydrogen, corresponding to 0.000 1–0.027 g/t annual chlorine capacity, while another plant reports concentrations of 10–1 600 $\mu\text{g}/\text{m}^3$ in hydrogen not used, corresponding to 0.001 46–0.233 g/t annual chlorine capacity [57, CAK TWG 2012].

Further hydrogen streams are produced from end-boxes, wash boxes and caustic storage tanks and are referred to as 'weak hydrogen'. They may be treated by using the same techniques (Section 8.2.3.2) [86, Euro Chlor 2010], [87, Euro Chlor 2006].

Hydrogen/nitrogen mixtures emitted during plant start-up cannot be treated due to safety reasons (no pressure loss allowed), but generally result in very low mercury emissions. There are, however, particular exceptional occasions when hydrogen must be emitted directly from the cells or when the treatment unit must be bypassed. These streams may contain appreciable quantities of mercury [3, Euro Chlor 2011], [86, Euro Chlor 2010].

3.5.6.3.5 Vents from storage

The storage and handling of mercury-contaminated material may lead to diffuse emissions of mercury from storehouses. Emissions depend mainly on the type of storage (open/closed), the storage temperature and the amount of mercury-contaminated material in storage.

Metallic mercury is generally stored in closed containers of up to one tonne or in bottles in a separate storage area [87, Euro Chlor 2006], [196, Euro Chlor 2012]. Emissions from storage and handling can be reduced by using large containers instead of bottles.

3.5.6.3.6 Exhausts and vents from the recovery retort

In the mercury recovery retort, waste contaminated with mercury is distilled in order to reduce the mercury content of the waste. The flue-gas leaving the retort contains mercury in considerable concentrations and is usually treated like other process exhausts (Section 3.5.6.3.1) [87, Euro Chlor 2006]. The ventilation air from the room where the recovery retort is installed may be an additional source of mercury emissions. One plant reports mercury concentrations of 2.6–23.4 $\mu\text{g}/\text{m}^3$, corresponding to 0.001 27–0.011 39 g/t annual chlorine capacity [57, CAK TWG 2012].

3.5.6.3.7 Vents from workshops

Another emission source may be the ventilation air from workshops where equipment contaminated with mercury is handled. One plant reports mercury concentrations of 1–23.6 $\mu\text{g}/\text{m}^3$ for this source, corresponding to 0.000 49–0.011 49 g/t annual chlorine capacity [57, CAK TWG 2012].

3.5.7 Emissions to water

3.5.7.1 Overview

The emissions to water specific to mercury cell plants relate to mercury and to ancillary materials used for its removal. Other emissions are described in Section 3.4 on emissions and waste generation relevant to all three cell techniques. Mercury-contaminated waste water includes [1, Ullmann's 2006], [91, Euro Chlor 2011]:

- the process waste water: brine purge, (back)washing water from brine purification, condensate and wash liquor from the treatment of chlorine and hydrogen, condensate from caustic concentration units, brine leakage, ion-exchange eluate from process-water treatment;
- the wash water from the cell cleaning operations: inlet and outlet boxes;
- the rinsing water from the cell room: cleaning of the floors, tanks, pipes and dismantled apparatuses;
- the rinsing water from maintenance areas outside the cell room, if they are cleaned with water.

The depleted brine from the cells contains some dissolved mercury. The largest part of this mercury is recirculated into the cells. Part of the mercury is discharged through the purge of the brine circuit.

The condensate from hydrogen drying contains mercury, but can be recycled as feed water to the decomposer.

The wash water from the inlet boxes flushes entrained caustic from the recycled mercury. This water contains mercury, but can be used as feed water to the decomposer, like the condensate from hydrogen drying. The wash water from the outlet boxes flushes entrained brine from the amalgam. This water also contains mercury, but can also be reused as feed water to the electrolytic cells.

There can be considerable emissions of mercury with run-off water. The soil at many sites is contaminated with mercury due to the deposition of diffuse emissions and/or historical disposal of mercury-contaminated wastes. Mercury can leak from the soil and end up in the run-off water.

Rainwater is normally collected and treated with the other water streams of the plant. In some plants, the rainwater is collected in sewer systems.

The amount of waste water can be reduced by separately disposing of the cooling water and process water and by feeding the condensate and wash water from the end-boxes back into the process, provided the water balance allows for this. Waste water volumes of 0.3–1.0 m³/t chlorine produced are achievable [1, Ullmann's 2006]. Waste water volumes generated in once-through brine plants are approximately 10 m³/t chlorine produced (Section 4.3.2.3.6). Usually all waste water streams (potentially) contaminated with mercury are combined and commonly treated. The same techniques are used during normal during plant operation and during decommissioning. They are described in Section 4.1.3.1.

3.5.7.2 Emission levels

3.5.7.2.1 Mercury

Mercury emission loads to water based on data collected in 2013 range from 0.00 to 0.82 g/t annual chlorine capacity, the median being 0.03 g/t annual chlorine capacity. The two mercury cell plants in the EU-27 using a once-through brine system show both specific mercury emissions to water of 0.05 g/t annual chlorine capacity, which is higher than the EU-27 median. However, mercury emissions also depend on other plant-specific factors and several plants in the EU-27 using a brine recirculation system show higher emissions to water (Table 3.30).

Reported emission concentrations are summarised in Table 3.35.

Table 3.35: Emissions of mercury to water from mercury cell plants in the EU-27 and EFTA countries in 2008 to 2011

Concentrations of mercury in µg/l ⁽¹⁾							
Value reported ⁽²⁾	Min.	10th percentile	25th percentile	Median	75th percentile	90th percentile	Max.
Min. ⁽³⁾	0.20	0.39	0.63	1.8	6.1	15	73
Max. ⁽⁴⁾	1.0	2.7	11	35	61	138	500
Average ⁽⁵⁾	1.7	7.2	9.7	19	37	70	133

⁽¹⁾ Coverage: mercury cell plants with both brine recirculation and once-through brine systems. Data refer to the outlet of the electrolysis plant prior to mixing with other waste water. Data from 23 plants. 11 of these plants reported ranges with minimum and maximum values, 5 of these plants reported annual average values and 7 of these plants reported both. The majority of the plants performed daily measurements while a few performed continuous measurements. 24-hour composite samples were mostly taken, as well as a few grab samples.

⁽²⁾ For a better understanding of the data, refer to Table 3.1.

⁽³⁾ 17 data from 17 plants. **In addition, 1 plant reported a value below the detection limit.**

⁽⁴⁾ 18 data from 18 plants.

⁽⁵⁾ 12 data from 12 plants. Annual average values.

Source: [57, CAK TWG 2012]

3.5.7.2.2 Sulphides

If mercury is precipitated as mercury sulphide, the sulphides are usually added in a slight stoichiometric excess, which remains in the waste water if not treated (e.g. by addition of hydrogen peroxide). One mercury cell plant reported sodium hydrogen sulphide concentrations

of 0.7–30.3 mg/l (daily measurements) at the outlet of the electrolysis plant, while another reported sulphide concentrations of < 1–30 mg/l [57, CAK TWG 2012].

3.5.8 Emissions via products

Some of the mercury leaves the process via the chlorine, hydrogen and caustic produced and may therefore be emitted to the environment during subsequent uses.

Hot, moist chlorine leaving the cells contains small amounts of mercury, which is mostly washed out in the subsequent cooling process and may be fed back into the brine with the condensate. The residual mercury is mostly trapped in sulphuric acid during chlorine drying. Two plants report mercury concentrations of 0.085 and 10 mg/kg sulphuric acid. Mercury concentrations in cool and dry chlorine gas are low and typically < 1 µg/kg [57, CAK TWG 2012], [86, Euro Chlor 2010], [87, Euro Chlor 2006].

Mercury emissions from hydrogen which is neither emitted nor burnt are included in the overall figures of emissions via products. Treatment techniques and residual mercury concentrations are described in Section 3.5.6.3.4.

Caustic soda and potash are filtered to reduce mercury concentrations in the final product. A variety of filters are used, including plate filters with a carbon pre-coat, as well as candle filters with or without a carbon pre-coat. Although all types of filters can achieve very low levels of mercury in the product, the predominant technique used is the plate filter with a carbon pre-coat. Mercury concentrations in filtered caustic are typically about 50 µg/l in 50 wt-% caustic, corresponding to emission loads of approximately 0.1 g/t annual chlorine capacity (Section 8.2.5) [87, Euro Chlor 2006].

Overall mercury emission loads via products in 2013 ranged from 0.01 to 0.15 g/t annual chlorine capacity, the median being 0.06 g/t annual chlorine capacity (Table 3.30). Mercury contained in caustic is usually the largest contributor to emissions via products.

3.5.9 Generation of wastes

3.5.9.1 Overview

Wastes generated specific to mercury cell plants relate to those contaminated with mercury. The wastes described in Section 3.4 on emissions and waste generation relevant to all three cell techniques usually fall under this category.

Solid wastes can arise at several points in the process as shown in Figure 3.6.

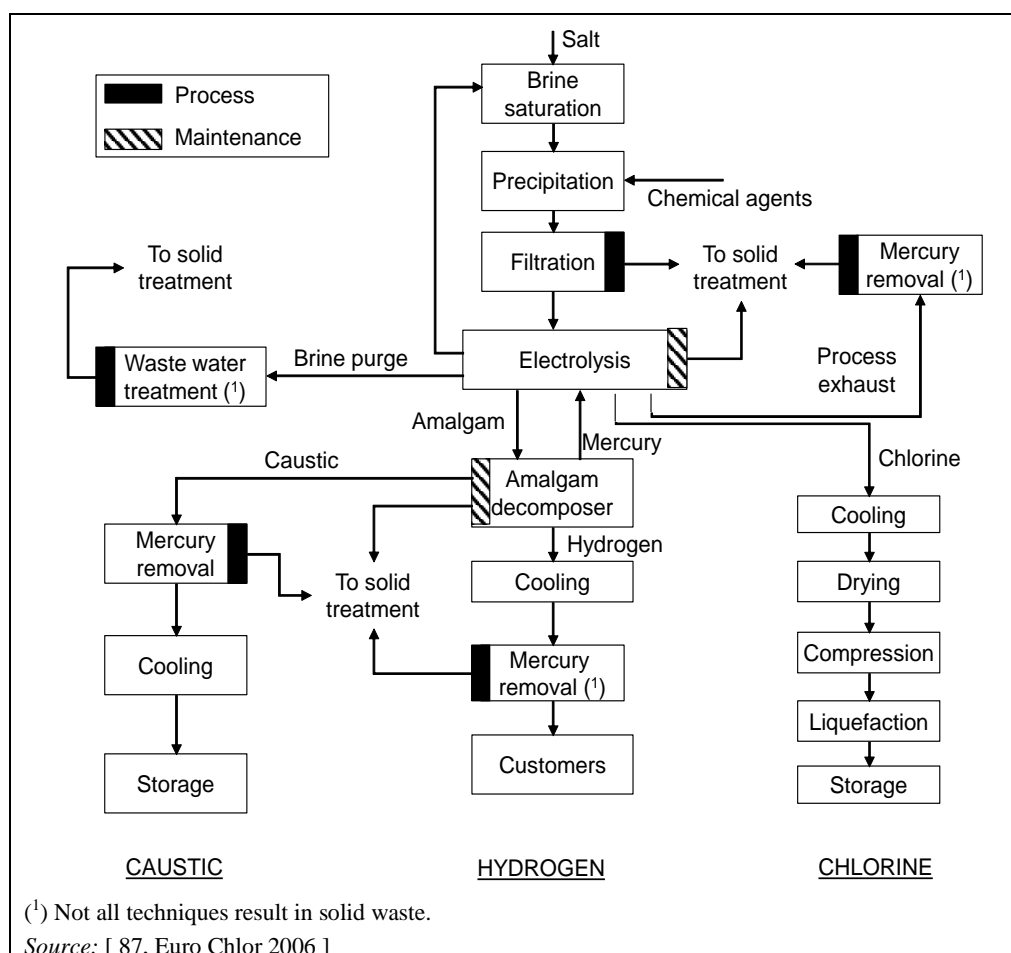

Figure 3.6: Major solid waste sources in mercury cell plants

Wastes contaminated with mercury include [87, Euro Chlor 2006]:

- solids from brine purification (Section 3.5.9.2)
- solids from caustic filtration (Section 3.5.9.3)
- solids from waste water treatment (Section 3.5.9.4)
- solids from sludge (sewer, traps, channels)
- activated carbon from the treatment of gaseous streams (Section 3.5.9.5)
- graphite from decomposer packing (Section 3.5.9.6)
- residues from retorts (Section 3.5.9.7)
- wastes from maintenance and renewal (Section 3.5.9.8).

3.5.9.2 Solids from brine purification

The quantities of precipitated solids depend on the purity of the salt used to make the brine (Section 3.4.3.4, Table 3.22). In the case of plants using the once-through brine process, purification and filtration are carried out prior to the cell and there is no contact of the purification sludges with mercury. In the case of plants using a brine recirculation process, the mercury-contaminated filter cakes are often washed to displace the residual mercury-containing brine. The sludge is then distilled at the plant, temporarily stored, or sent to a deposit. In some cases, the filter cakes are dissolved and pumped to the waste water treatment unit, and the sludge therefrom is distilled at the plant, temporarily stored, or sent to a deposit [3, Euro Chlor 2011].

Reported mercury concentrations in sludges from primary brine purification are summarised in Table 3.36.

Table 3.36: Mercury concentrations in sludges from primary brine purification of mercury cell plants in the EU-27 and EFTA countries in 2008 to 2011

Mercury concentrations in sludges from primary brine purification in g/t waste ⁽¹⁾ ⁽²⁾							
Value reported ⁽³⁾	Min.	10th percentile	25th percentile	Median	75th percentile	90th percentile	Max.
Min. ⁽⁴⁾	1.0	10	10	50	150	360	3 000
Max. ⁽⁵⁾	3.0	31	95	220	310	1 800	15 000
Average ⁽⁶⁾	0.0	18	25	72	160	1 100	2 000
⁽¹⁾ Data from 35 plants: 13 plants reported ranges with minimum and maximum values, 17 plants reported annual average values and 5 plants reported both. ⁽²⁾ 13 plants out of a total of 25 reported solids contents in the brine sludge which ranged from 35 wt-% to 100 wt-%. ⁽³⁾ For a better understanding of the data, refer to Table 3.1. ⁽⁴⁾ 11 data from 11 plants. In addition, 1 plant reported a value below the detection limit and 1 plant a value of < 200 g/t waste. ⁽⁵⁾ 12 data from 12 plants. In addition, 1 plant reported a value of < 200 g/t waste. ⁽⁶⁾ 17 data from 17 plants. Annual average values. <i>Source: [57, CAK TWG 2012]</i>							

3.5.9.3 Solids from caustic filtration

The sludge from caustic filtration consists of a carbon pre-coat contaminated with significant amounts of mercury. It is dewatered and in some cases led to a mercury recovery retort (Section 3.5.9.7). The residual solid waste is subsequently disposed of. In other cases, the sludge is disposed of without mercury recovery [3, Euro Chlor 2011].

3.5.9.4 Solids from waste water treatment

The different treatment techniques for mercury-contaminated waste water (Section 4.1.3.1) result in different types of solid waste. Ion-exchange resins can usually be regenerated with hydrochloric acid. Otherwise, the resins can be treated as solid waste, retorted, or sent to underground storage. Precipitated mercury sulphide filtered from the waste water may be dissolved and fed back into the brine system, treated in the mercury distillation unit, or disposed of as stabilised mercury sulphide. Activated carbon contaminated with mercury from adsorptive treatment is usually treated by distillation [94, Euro Chlor 2009].

3.5.9.5 Activated carbon from treatment of gaseous streams

Solid waste results when process exhaust or hydrogen is treated with iodised or sulphurised activated carbon or with metals on a carrier. The activated carbon may be treated chemically or sent for disposal [3, Euro Chlor 2011], [87, Euro Chlor 2006].

3.5.9.6 Graphite from decomposer packing

The packing within the decomposers (the reactors where the mercury/sodium amalgam is converted to caustic soda and hydrogen) is usually composed of graphite balls or granules. During normal use, there is an attrition of the graphite and approximately every 10 years decomposers will need repacking. The graphite, typically containing 1–10 wt-% mercury, can be retorted. The quantity of graphite is approximately 1–2 g/t annual chlorine capacity [75, COM 2001].

3.5.9.7 Residues from retorts

The retorting or distillation process can be applied to most materials containing metallic mercury, such as caustic filter media and decomposer graphite, stock tank sludges, etc. The distilled mercury is recovered. However, not all contaminated wastes can be retorted because some produce volatile mercury compounds which are difficult to remove from the process exhaust. The solid residue is landfilled or stored underground (e.g. in mines) [87, Euro Chlor 2006], [94, Euro Chlor 2009]. The residue typically contains from < 10 to 200 mg Hg/kg waste. In some cases, particularly concerning materials with very fine pore sizes, this may increase to approximately 1 000 mg Hg/kg waste. Under normal circumstances, the quantity of retort residues will be determined by the volume of caustic filtration solids and is typically about 5 g/t annual chlorine capacity. However, retorts are frequently worked in campaigns and the quantity may be highly augmented by special activities, such as stock tank recoveries or sump cleaning [75, COM 2001].

3.5.9.8 Wastes from maintenance and renewal

By their nature, both the quantity and character of these wastes is highly variable. Materials include personal protective equipment, process equipment and construction materials.

3.5.9.9 Waste generation levels

Most of the mercury which leaves an installation is contained in waste. In 2013, mercury in waste disposed of by chlor-alkali plants in the EU-27 and EFTA countries ranged from 0 to 194 g/t annual chlorine capacity, the median being 4.3 g/t annual chlorine capacity (Table 3.30). In general, the amount of waste disposed of varies considerably from one year to the next, depending on the type of maintenance work which is carried out and other factors, such as the time during which waste is temporarily stored on site. Table 3.37 and Table 3.38 provide examples of waste types, amounts, applied treatments and mercury contents from two mercury cell plants in Sweden.

Table 3.37: Waste generation and treatment at the AkzoNobel chlor-alkali plant in Bohus (Sweden) in 1998/1999

Waste type	Waste amount in t/yr ⁽¹⁾	Mercury content before treatment in g/kg	Treatment	Final mercury content in mg/kg
Brine sludge	12–20	0.050–0.150	Landfilled after stabilisation	NI
Waste water treatment sludge	30–40	15–30	<ul style="list-style-type: none"> • Distilled • Landfilled after stabilisation 	< 10
Carbon sludge	2	150–300	<ul style="list-style-type: none"> • Distilled • Landfilled after stabilisation 	20–200
Decomposer carbon	2	15–30	<ul style="list-style-type: none"> • Distilled • Landfilled after stabilisation 	20–200
Rubber lining	0.5	NI	<ul style="list-style-type: none"> • Acid bath • Incineration 	300
Steel/iron construction parts	Varies	NI	<ul style="list-style-type: none"> • Acid bath • Sold as scrap 	< 5
Concrete and other construction waste	Varies 5 t/yr in 1998	NI	Landfilled as hazardous waste or as other waste, depending on content	> 5 < 5

(¹) Chlorine capacity 100 kt/yr; production based on vacuum salt.
 NB: NI = no information provided.
 Source: [75, COM 2001]

Table 3.38: Waste generation and treatment at the Hydro Polymers AB chlor-alkali plant in Stenungsund (Sweden)

Waste type	Waste amount in t/yr ⁽¹⁾	Mercury content before treatment in g/kg	Treatment	Final mercury content in mg/kg
Brine sludge	20–25	0.050–0.100	Landfilled	NI
Waste water treatment sludge	5–15	5–10	<ul style="list-style-type: none"> • Distilled • Landfilled after stabilisation 	< 10
Carbon sludge	2–3.5	150–450	<ul style="list-style-type: none"> • Distilled • Landfilled after stabilisation 	20–200
Decomposer carbon	0.5–1	150–300	<ul style="list-style-type: none"> • Distilled • Landfilled after stabilisation 	20–200
Rubber lining	0.5	NI	<ul style="list-style-type: none"> • Acid bath • Incineration 	300
Steel/iron construction parts	10–15	NI	<ul style="list-style-type: none"> • Acid bath • Sold as scrap 	< 15
Concrete and other construction waste	1–3	0.010–0.400	Landfilled after stabilisation	NI

(¹) Chlorine capacity 120 kt/yr; production based on vacuum salt.
 NB: NI = no information provided.
 Source: [75, COM 2001]

3.5.10 Mass balance calculation

A mercury balance consists in comparing all mercury inputs to and outputs from a chlor-alkali plant during a specified time. Conducting periodic mercury balances is a useful method to better understand mercury consumption and emissions levels. Guidelines for making such a balance are available and all Euro Chlor member companies have committed themselves to follow them. In theory, inputs should equal outputs, but there are two disturbing factors: the measurement uncertainty and the accumulation of mercury in equipment [86, Euro Chlor 2010]. As a consequence, the mercury balance for an individual plant varies considerably from one year to the next, is frequently positive but sometimes negative, and is often much higher than the total emissions to air, water and via products. In 2009, the 'difference to balance' ranged from -35 to 210 g/t annual chlorine capacity for individual chlor-alkali plants in OSPAR countries, the median being 2.6 g/t annual chlorine capacity [85, Euro Chlor 2011]. In parallel with mercury consumption, the average difference to balance of chlor-alkali plants in OSPAR countries was reduced by 85 % from 1977 to 2008, due to improvements in technology, analytical methods and operating procedures (Figure 3.7) [96, Euro Chlor 2010].

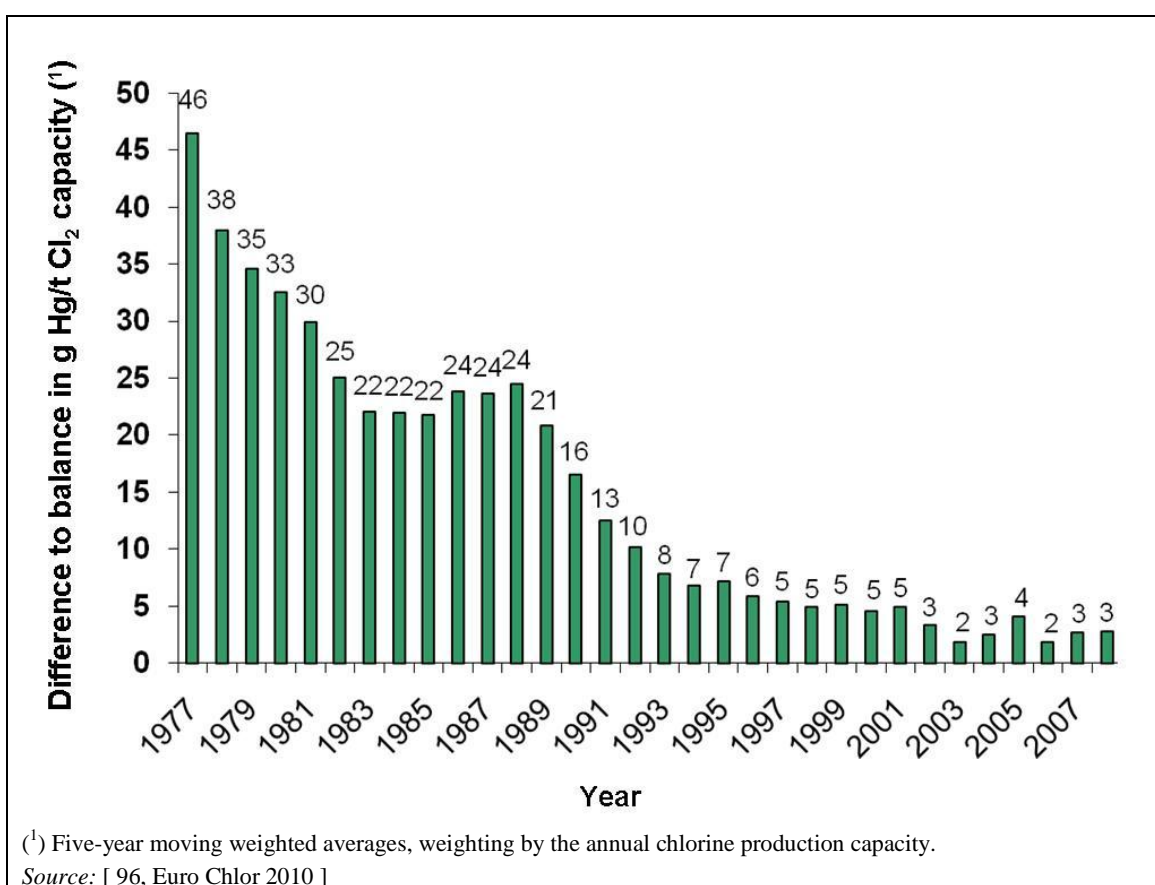

Figure 3.7: Trend of the average difference to balance for chlor-alkali plants in OSPAR countries from 1977 to 2008

The fact that the difference to balance is often much higher than the total emissions means that significant amounts of mercury remain unaccounted for, which has led to controversies. Environmental NGOs have argued that actual emissions could be higher than those reported [95, EEB 2008], [97, Concorde 2006], [101, US EPA 2008].

Several factors contribute to the measurement uncertainty. The determination of the consumption levels requires the measurement of mercury in cells at the beginning and at the end of the reporting period. The best measurement method uses radioactive tracers and has an uncertainty of 0.5–1 % [86, Euro Chlor 2010], [101, US EPA 2008]. With a median cell

inventory of 1.6 kg Hg/t annual chlorine capacity (Table 3.29), this corresponds to an uncertainty of 8–16 g Hg/t annual chlorine capacity, a value which is approximately 12–25 times higher than the median of the total emissions of chlor-alkali plants in the EU-27 and EFTA countries (Table 3.30). In addition, the uncertainty for the consumption levels increases further when the difference between the cell inventory at the beginning and at the end of the balancing period is calculated (two large figures are subtracted from each other) and when the uncertainty of the variation of the quantities in storehouses is taken into account. Further contributions to the measurement uncertainty originate from the monitoring of emissions to air and water and from the determination of mercury in wastes, which are typically about 10 % and 50 %, respectively [86, Euro Chlor 2010].

The mercury difference to balance is also due to the fact that mercury progressively accumulates inside pipes, tanks, traps, sewers and in sludges. This mercury is sometimes recovered during maintenance, but usually remains there until the decommissioning of the plant. The mercury accumulation explains why the calculated difference to balance is usually positive. It may be negative when recoveries occur. When the difference to balance over the lifetime of a plant is considered, a substantial proportion of mercury can be recovered during the dismantling of the installation and equipment, but is nevertheless limited by the degree of efficiency of the final recovery operation (mercury may remain amalgamated in metals or absorbed in construction materials) [96, Euro Chlor 2010].

3.5.11 Emissions and waste generation during other than normal operating conditions

3.5.11.1 Emissions during start-up and shutdown operations

Start-up and shutdown operations generally lead to increased hydrogen emissions (Section 3.4.7.1). During these periods, safety requirements do not allow the hydrogen to pass through the mercury treatment unit, thereby leading to increased mercury emissions to air from this source. On the other hand, there is no indication that emissions of mercury from the cell room during start-up and shutdown operations are different from those under normal operating conditions [196, Euro Chlor 2012].

3.5.11.2 Emissions during incidents and accidents

Mercury emissions from incidents and accidents are by nature discontinuous, but may nevertheless contribute to the overall mercury emissions of a mercury cell plant. Fugitive emissions of mercury are described in Section 3.5.6. Three examples of incidents that occurred at a mercury cell plant that led to elevated mercury emissions to the sea are listed below [297, Inspector's report 2005]:

- At the beginning of June 2005, an overflow of brine containing dissolved mercury from a tank due to clogged equipment led to mercury emissions of 933 g, as reported by the company.
- At the beginning of July 2005, the start-up of the plant after a strike and the lack of suitable monitoring led to mercury emissions of 734 g.
- At the end of July 2005, a malfunctioning valve and maintenance works led to mercury emissions of 2.05 kg.

These three incidents together were equivalent to mercury emissions to water of 0.022 g/t annual chlorine capacity (chlorine production capacity of mercury cell plant 166 kt/yr), compared to total mercury emissions to water in 2005 of 0.141 g/t annual chlorine capacity [55, Euro Chlor 2014].

3.5.11.3 Emissions and waste generation during decommissioning

In general, mercury emissions during decommissioning are expected to be lower than during operation. Although the mercury concentrations in workspace air are usually higher during decommissioning than during normal operation, mercury emissions to air during decommissioning are usually lower because the cell room temperature decreases once the cells are shut down, which greatly reduces the ventilation airflow [237, Lindley 1997]. For example, total mercury emissions to air and water during decommissioning of a mercury cell plant in Sabinánigo (Spain) amounted to 2.5 kg and 25 g, respectively, corresponding to emission loads of 0.1 and 0.001 g/t annual chlorine capacity. These emission loads are more than fivefold lower than those reported during normal plant operation [275, ANE 2010]. Significantly reduced emissions during decommissioning compared to normal operation were also reported by another plant, in Roermond (Netherlands) [278, Verberne and Maxson 2000].

Large amounts of wastes consisting of elemental mercury and of wastes contaminated with mercury are generated during decommissioning. Most of the mercury incurred during decommissioning is in its elemental form. Metallic mercury no longer used in the chlor-alkali industry is considered waste [279, Regulation EC/1102/2008 2008]. The quantities of metallic mercury contained in cells in operation are shown in Table 3.29. Table 3.39 provides data from example plants on mercury quantities collected, recovered, or disposed of with waste during decommissioning.

Table 3.39: Mercury collected, recovered, or disposed of with waste during decommissioning of mercury cell plants

Location [Reference]	Chlorine production capacity ⁽¹⁾ kt/yr	Metallic mercury collected ⁽²⁾		Other metallic mercury recovered ⁽³⁾		Mercury disposed of with waste	
		t	kg/t annual chlorine capacity	t	kg/t annual chlorine capacity	t	kg/t annual chlorine capacity
Delfzijl (Netherlands) [278, Verberne and Maxson 2000]	48	61.5	1.3	13.5	0.28	14	0.29
Bohus (Sweden) [278, Verberne and Maxson 2000]	6	9	1.5	7.25	1.2	NI	NI
Skoghall (Sweden) [278, Verberne and Maxson 2000]	80	195	2.4	12	0.15	10	0.13
Saint Auban (France) [276, French Ministry 2010]	184	400	2.2	NI	NI	> 30	> 0.16
Sabiñánigo (Spain) [275, ANE 2010]	25	45.2	1.8	0.754	0.030	NI	NI
Billingham (United Kingdom) [277, Dring 2010]	69	239	3.5	12	0.17	NI	NI
Cornwall/Ontario (Canada) [278, Verberne and Maxson 2000]	50	107	2.1	1	0.02	12.5	0.25
Hillhouse (United Kingdom) [277, Dring 2010]	98	373	3.8	NI	NI	NI	NI
Runcorn (United Kingdom) [277, Dring 2010]	188	426	2.3	159	0.85	NI	NI
Wilton (United Kingdom) [277, Dring 2010]	69	209	3.0	35	0.51	NI	NI
Roermond (Netherlands) [278, Verberne and Maxson 2000]	146	225	1.5	8	0.05	11	0.075

⁽¹⁾ Chlorine production capacity of the mercury cell unit at the time of decommissioning.
⁽²⁾ Metallic mercury collected from storage facilities and cells, including from piping systems.
⁽³⁾ Other metallic mercury obtained from cleaning and/or recovery operations, such as retorting.
NB: NI = no information provided.

3.6 Emission and consumption levels and waste generation from diaphragm cell plants

3.6.1 Overview

The only issue of concern that is specific to diaphragm cell plants relates to the consumption and emissions of asbestos, as well as the generation of asbestos-containing waste, in the case of plants using asbestos diaphragms. Chrysotile asbestos is the only form of asbestos used. Regulation EC/1907/2006 concerning the Registration, Evaluation, Authorisation and Restriction of Chemicals (REACH) generally prohibits the use of asbestos fibres, but EU Member States can grant an exemption for the use of chrysotile asbestos-containing diaphragms in existing electrolysis installations until they reach the end of their service life, or until suitable asbestos-free substitutes become available, whichever is sooner (ANNEX XVII, number 6.(f)) [287, REACH Regulation (EC) No 1907/ 2006].

Dry asbestos fibres can cause serious health problems if not properly used and handled in the diaphragm cell technique. Asbestos fibres are thin and sharp crystals, which can be split into even thinner crystals. Due to its physical properties, asbestos is considered to be carcinogenic. The fibres are insoluble in body fluids and easily penetrate cell membranes. They can enter the human body by either inhalation or ingestion.

3.6.2 Consumption levels

The only ancillary material of concern consumed specifically by diaphragm cell plants relates to asbestos, in the case of plants using asbestos diaphragms. Other consumption levels are described in Section 3.3 on consumption levels relevant to all three cell techniques.

Consumption levels of asbestos have decreased significantly since the replacement of graphite anodes by metal anodes and of pure asbestos diaphragms by diaphragms consisting of a mixture of asbestos and fluorocarbon polymers. They range from 0.1 to 0.3 kg per tonne of chlorine produced [75, COM 2001]. In 2013, all but one diaphragm cell plants in the EU-27 used asbestos-free diaphragms.

3.6.3 Emissions to air

The emissions to air specific to diaphragm cell plants relate to asbestos, in the case of plants using asbestos diaphragms. Other emissions are described in Section 3.4 on emissions and waste generation relevant to all three cell techniques.

Emissions of asbestos to air can occur during the preparation of the diaphragms and, excluding potential accidental releases during transportation, unloading and storage, the major potential sources of emissions to air are during bag handling and opening, and the disposal of spent asbestos.

Three sources of asbestos emissions can be identified in the cell room maintenance area:

- waste gas from the compressor;
- waste gas from the drying oven;
- waste gas from the asbestos weighing room.

Reported asbestos concentrations are summarised in Table 3.40.

Table 3.40: Concentrations of asbestos in air in asbestos diaphragm cell plants in the EU-27

Plant	Asbestos concentration	
	In workspace air	At outlet of ventilation air from areas where asbestos is handled (storage and diaphragm preparation)
	fibres/m ³	
Dow in Stade (Germany)	< 1 000 ⁽¹⁾	< 100 ⁽²⁾
Solvay in Rheinberg (Germany) ⁽³⁾	< 1 000 ⁽⁴⁾	< 1 ⁽⁵⁾
Zachem in Bydgoszcz (Poland) ⁽⁶⁾	5 000–30 000 ⁽⁷⁾	NI

⁽¹⁾ Occupational exposure limit value: 1 000 fibres/m³.
⁽²⁾ Measurement once every three years during undisturbed operation with a maximum emission level. Data from 2007 and 2010. Limit of detection: 100 fibres/m³. Emission limit value: 1 000 fibres/m³.
⁽³⁾ Plant converted to non-asbestos diaphragms in 2012.
⁽⁴⁾ Measurement once per year. Occupational exposure limit value: 1 000 fibres/m³.
⁽⁵⁾ Measurement once every three years during undisturbed operation with a maximum emission level. Data from 2008 and 2011. Sampling duration ~ 30 min. Limit of detection: 1 fibre/m³. Emission limit value: 10 000 fibres/m³.
⁽⁶⁾ Plant was shut down in 2012.
⁽⁷⁾ Measurement every six months in the electrolysis workshop (containing the mixer to prepare the asbestos pulp). Data from 1996 to 2010. Occupational exposure limit value: 100 000 fibres/m³.
 NB: NI = no information provided.
 Source: [215, German Ministry 2011], [220, Polish Ministry 2011], [298, Euro Chlor 2013], [301, Zachem 2012], [303, GSA 2007], [304, GSA 2010], [305, ERGO 2008], [306, Müller-BBM 2011]

Directive 2009/148/EC requires employers to ensure that no worker is exposed to an airborne concentration of asbestos in excess of 100 000 fibres per m³ as an 8-hour time-weighted average [302, Directive 2009/148/EC 2009].

Directive 87/217/EEC sets an emission limit value of 0.1 mg asbestos per m³ of air discharged through the discharge ducts for activities which involve handling a quantity of more than 100 kg of raw asbestos per year, which is the case in chlor-alkali plants using asbestos diaphragms [79, Directive 87/217/EEC 1987].

3.6.4 Emissions to water

The emissions to water of specific concern to diaphragm cell plants relate to asbestos, in the case of plants using asbestos diaphragms. Other emissions are described in Section 3.4 on emissions and waste generation relevant to all three cell techniques.

At the end of the lifetime of an asbestos diaphragm, the asbestos is removed from the cathode by means of high-pressure water-jet cleaning. Asbestos is collected with the rinsing water and can be discharged. A filter press is usually installed to remove asbestos from the rinsing water. Reported emissions give values of under or equal to 30 mg/l [75, COM 2001].

3.6.5 Generation of wastes

The generation of wastes specific to diaphragm cell plants relate to scrapped cell parts, including cell covers, piping and used diaphragms. The latter are of concern in the case of plants using asbestos diaphragms. Other types of waste generated are described in Section 3.4 on emissions and waste generation relevant to all three cell techniques.

The lifetime of asbestos diaphragms in modern diaphragm cell plants depends on the current density and ranges from 0.5 to 1.0 years at ~ 2.7 kA/m², from 1 to 2 years at ~ 1.3 kA/m² and from 5 to 10 years at ~ 0.6 kA/m² [1, Ullmann's 2006], [10, Kirk-Othmer 2002],

[293, Euro Chlor 2012]. After this period, the cell is taken out of operation and the old asbestos is removed from the cathode. Reported figures for asbestos waste from three plants amounted to 64, 80 and 160 g/t annual chlorine capacity [57, CAK TWG 2012], [215, German Ministry 2011], [301, Zachem 2012].

Discarded cell parts are thermally treated, chemically treated and/or landfilled, depending on the legislation of the country.

3.7 Emission and consumption levels and waste generation from membrane cell plants

3.7.1 Consumption and emission levels

Consumption and emission levels of membrane cell plants are fully described in Sections 3.3 and 3.4, respectively, which cover consumption and emission levels relevant to all three cell techniques.

3.7.2 Generation of wastes

The generation of wastes specific to membrane cell plants relate to sludges generated during secondary brine purification, as well as to scrapped cell parts, including gaskets and membranes. Other types of waste generated are described in Section 3.4 on emissions and waste generation relevant to all three cell techniques.

Wastes are generated during secondary brine purification and consist of used materials such as pre-coat and body feed material made of cellulose. The pre-coat filter sludge from the brine softener consists mainly of alpha-cellulose, contaminated with iron hydroxide and silica. Reported figures for waste generation are shown in Table 3.41.

Table 3.41: Generation of sludges from secondary brine purification in membrane cell plants in the EU-27 in 2009 to 2011

Generation of sludges from secondary brine purification in kg per tonne of chlorine produced ⁽¹⁾ ⁽²⁾				
Min.	25th percentile	Median	75th percentile	Max.
0.080	0.26	0.37	0.55	1.0
⁽¹⁾ Annual average values. ⁽²⁾ 10 data from 10 plants. 1 plant reported a solid content of 65 wt-%. <i>Source:</i> [57, CAK TWG 2012]				

Ion-exchange resins for secondary brine purification are very rarely changed. Resins are regenerated approximately 30 times per year. In 2008/2009, reported figures for ion-exchange resin wastes from two membrane cell plants amounted to 4 and 5.6–6.7 g/t annual chlorine capacity [57, CAK TWG 2012].

Spent membranes and gaskets from membrane cells become waste after their service life. The membranes have a lifetime of between three and five years. The waste from cell gaskets and membranes has been estimated at approximately 60 g per tonne of chlorine produced (data from one membrane cell plant) [75, COM 2001]. Values reported for another plant amount to 4 g/t chlorine produced for gaskets [57, CAK TWG 2012] and approximately 3.3 g/t annual chlorine capacity for membranes [17, Dutch Ministry 1998].

3.8 Historical contamination of chlor-alkali sites

3.8.1 Overview

Many old chlor-alkali sites are contaminated with mercury in the case of mercury cell plants, as well as dioxins and furans (PCDDs/PCDFs), other halogenated organic compounds, and polycyclic aromatic hydrocarbons (PAHs) in the case of both mercury and diaphragm cell plants.

In one case, soil contamination with barium (from sulphate precipitation) and lead (from lead-containing equipment) was also reported with soil concentrations of up to 60 g/kg and 1 425 mg/kg, respectively [240, Otto et al. 2006], [242, Lutz et al. 1991].

The soil and groundwater contamination is due to both the deposition of atmospheric contaminants and the historical disposal of graphite sludges, from the use of graphite anodes, and other wastes on and around the sites.

In general, care has to be taken when associating pollution levels to pollution sources because of the often diverse activities on a specific site that may date back more than a hundred years. By nature, soil and groundwater contamination is inherently site-specific. The data displayed in the following sections thus have to be taken more as examples rather than as an attempt to set typical ranges.

3.8.2 Mercury

The contamination of soil with mercury is due to the atmospheric deposition, as well as to the historical disposal of graphite sludges from the use of graphite anodes and of other wastes on and around the site. The mercury may leach from the soil and end up in the run-off water and the groundwater. Mercury is mostly present in elemental form, but dissolved inorganic and organically bound mercury are also present. The redox potential of the soil determines the direction of conversion [245, Euro Chlor 2012], [246, Wanga et al. 2004], [247, Orca 2011].

The soil beneath the production units can be contaminated with mercury up to several metres deep, especially the areas beneath the cell room and the retorting unit where concentrations can be as high as some g/kg of dry soil [245, Euro Chlor 2012].

As far as contamination through atmospheric deposition is concerned, experience has shown that mercury concentrations in the topsoil (~ 30 cm) could vary from some µg/kg up to some hundreds of mg/kg within the first kilometres downwind from the cell room. The prevailing wind direction has, not surprisingly, a major influence on the deposition rates and hence the topsoil contamination levels [245, Euro Chlor 2012], [249, Biester et al. 2002], [250, Maserti and Ferrara 1991]. However, most of the metallic mercury directly or indirectly released to air from the plant is subject to atmospheric long-range transport [249, Biester et al. 2002]. In some cases, the concentrations in soils due to deposition were reported to reach background levels at a relatively short distance (4–5 km from the plant) [250, Maserti and Ferrara 1991], while in other cases, this distance was reported to be as high as 100 km [251, Lodenius and Tulisalo 1984]. When soluble mercury is bound to organic matter, the contamination reached depths of approximately 20–50 cm in the soil. However, in sandy soils lacking organic matter, contamination was restricted to the upper 5 cm. This means that reactive mercury forms are effectively retained through sorption on mineral surfaces [248, Biester et al. 2002].

At some sites, discharge of mercury-containing waste water has led to contamination of river sediments [265, Hissler and Probst 2006].

Table 3.42 contains an estimation of the total number of mercury-contaminated chlor-alkali sites in the EU-27 and EFTA countries with estimated contamination levels. The estimate of the total amount of mercury present at contaminated sites varies largely from 3 to 19 kt, the median being estimated to be approximately 10 kt [241, COWI 2008].

Table 3.42: Estimation of total number of mercury-contaminated chlor-alkali sites in the EU-27 and EFTA countries and contamination levels

	Number of sites	Contamination level in t of mercury per site	Total contamination level in t of mercury
	11–19	5–30	56–555
	22–37	30–100	666–3 700
	22–37	100–400	2 220–14 800
Total	56–93	NA	2 942–19 055
NB: NA = not applicable.			
Source: [241, COWI 2008]			

Table 3.43 lists examples of mercury-contaminated chlor-alkali sites in the EU-27 and EFTA countries.

Table 3.43: Examples of mercury-contaminated chlor-alkali sites in the EU-27 and EFTA countries

Country code	Site	Estimated amount of mercury	Contaminated area	Mercury concentration	Remarks [Reference]
		t	m ²	mg/kg of dry substance	
CZ	Neratovice	264	NI	NI	Hg in buildings is also included in this estimate. Soluble Hg(II) in groundwater and surface water: 154 kg [241, COWI 2008]
CZ	Ústí nad Labem	260–450	NI	NI	Soluble Hg(II) in groundwater: 10 kg [241, COWI 2008]
DE	NI	NI	NI	0.39–4.2	Effects of atmospheric deposition on soil within a distance of 100–1000 m downwind of three chlor-alkali plants. Locations are confidential [248, Biester et al. 2002], [249, Biester et al. 2002]
	NI	NI	NI	0.15–3.0	
	NI	NI	NI	0.46–2.3	
DE	Rheinfelden	NI	NI	maximum 24.4	Figure refers to soil [240, Otto et al. 2006]
FR	Vieux-Thann	100	NI	NI	[241, COWI 2008]
FR	Saint Auban	100	NI	NI	[241, COWI 2008]
HU	Balatonfüzfő	NI	NI	2 600	Figure refers to soil. Contamination depth: 2–3 m [241, COWI 2008]
HU	Kazincbarcika	360	NI	NI	[241, COWI 2008]
IT	Rosignano	NI	NI	70–610	Soil samples taken in direct vicinity of the chlor-alkali plant up to a distance of approximately 3 km [250, Maserti and Ferrara 1991]
NO	Porsgrunn	~ 29	40 000	NI	[241, COWI 2008]
NO	Sarpsborg	~ 17	90 000	NI	[241, COWI 2008]
SE	Bengtsfors	15	10 000	NI	[241, COWI 2008]
SE	Skoghall	8	60 000	NI	[241, COWI 2008]
SE	Skutskär	4	NI	1–110	Figures refer to 500 000 m ³ of sediment dredged from a harbour area [75, COM 2001], [278, Verberne and Maxson 2000]

NB: NI = no information provided.

3.8.3 PCDDs/PCDFs, PCBs, PCNs and PAHs

Graphite anodes were used almost exclusively for chlorine production before being replaced in the 1970s by metal anodes. The graphite anode was composed of various types of particulate coke mixed with a pitch binder. Some oxygen was liberated at the anodes with the chlorine, and this oxygen attacked the graphite, forming carbon monoxide and carbon dioxide. This electrode wear was the cause of a graphite consumption of approximately 2 kg per tonne of chlorine produced from sodium chloride and 3–4 kg per tonne of chlorine produced from potassium chloride. The graphite residue produced was contaminated with PCDDs/PCDFs and other halogenated organic compounds, such as polychlorinated naphthalenes (PCNs), mainly derived from the reaction between chlorine and the pitch binder containing polycyclic aromatic hydrocarbons (PAHs). Before the 1970s, the spent graphite was usually not incinerated but dumped in available pits near the site or in unsecured local landfills [1, Ullmann's 2006], [240, Otto et al. 2006], [242, Lutz et al. 1991]. Table 3.44 lists some examples of contaminated chlor-alkali sites.

Table 3.44: Examples of chlor-alkali sites contaminated with PCDDs/PCDFs, PCBs, PCNs and PAHs

Country code	Site	Estimated amount of pollutant	Dioxin-like pollutant concentration in $\mu\text{g TEQ/kg}$ of dry substance	Polychlorinated naphthalenes (PCNs) concentration in mg/kg of dry substance	Remarks [Reference]
DE	Bitterfeld	NI	NI	Penta-CN: 0.88 mg/kg Hexa-CN: 0.54 mg/kg Hepta-CN: 1.1 mg/kg	Composite sediment sample from creek affected by a chlor-alkali plant [260, Brack et al. 2003]
DE	Rheinfelden	8.5 kg TEQ PCDDs/PCDFs	PCDDs/PCDFs: maximum 26 in topsoil, maximum 3 800 in deep soil	NI	PAHs up to 4 345 mg/kg [240, Otto et al. 2006]
SE	NI	NI	PCDDs/PCDFs: 0.26 and 37	NI	Figures refer to soil samples [253, Nording et al. 2006]
SE	NI	NI	PCDDs/PCDFs: 7.6	Tri-CN: 1.7 mg/kg Tetra-CN: 2.9 mg/kg Penta-CN: 2.2 mg/kg Hexa-CN: 0.62 mg/kg	Aged soil of a chlor-alkali plant [254, van Bavel et al. 1999]
SE	Lake Vänern and lake Bengtsbrohöljen	NI	NI	Sum of Tri-, Tetra- and penta-CN: 0.008 0–0.26	Sediment samples from lakes affected by chlor-alkali plants [261, Järnberg et al. 1997]
US	Brunswick, Georgia	NI	PCDDs: 0.012–0.041 PCDFs: 0.62–1.3 PCBs: 1.6–29	Tri-CN: 0.05–0.1 mg/kg Tetra-CN: 0.53–0.65 mg/kg Penta-CN: 2.2–2.6 mg/kg Hexa-CN: 5.8–7.3 mg/kg Hepta-CN: 7.1–9.6 mg/kg Octa-CN: 2.0–3.3 mg/kg	Soil and sediment samples from marsh and creek affected by a chlor-alkali plant. The plant had used a mixture of PCBs as graphite electrodes lubricant [255, Kannan et al. 1998], [256, Kannan et al. 1997], [257, Kannan et al. 1998].

NB: NI = no information provided.

The mixture of PCDD/PCDF congeners found on contaminated chlor-alkali sites shows a specific pattern dominated by dibenzofurans, which is different to other sources [242, Lutz et al. 1991], [255, Kannan et al. 1998], [259, Rappe et al. 1991].

Similarly, the pattern of PCN congeners is also specific for contaminated chlor-alkali sites [260, Brack et al. 2003], [261, Järnberg et al. 1997]. When measured in parallel, total PCN concentrations on contaminated sites usually exceed those of PCBs and PCDDs/PCDFs by up to one order of magnitude (Table 3.44).

At PCDD/PCDF-contaminated sites, high levels of mercury in the soil do not necessarily correspond with high levels of PCDDs/PCDFs, and vice versa. This means that the mercury level is not an indicator of the PCDD/PCDF levels [243, Stenhammar 2000].

4 TECHNIQUES TO CONSIDER IN THE DETERMINATION OF BEST AVAILABLE TECHNIQUES

This chapter describes techniques (or combinations thereof), and associated monitoring, considered to have the potential for achieving a high level of environmental protection in the activities within the scope of this document. The techniques described will include both the technology used and the way in which the installations are designed, built, maintained, operated and decommissioned.

It covers environmental management systems, process-integrated techniques and end-of-pipe measures. Waste prevention and management, including waste minimisation and recycling procedures are also considered, as well as techniques that reduce the consumption of raw materials, water and energy by optimising use and reuse. The techniques described also cover measures used to prevent or to limit the environmental consequences of accidents and incidents, as well as site remediation measures. They also cover measures taken to prevent or reduce emissions under other than normal operating conditions (such as start-up and shutdown operations, leaks, malfunctions, momentary stoppages and the definitive cessation of operations).

Annex III to the Industrial Emissions Directive lists a number of criteria for determining BAT, and the information within this chapter will address these considerations. As far as possible, the standard structure in Table 4.1 is used to outline the information on each technique, to enable a comparison of techniques and the assessment against the definition of BAT in the Industrial Emissions Directive.

This chapter does not necessarily provide an exhaustive list of techniques which could be applied in the sector. Other techniques may exist, or may be developed, which could be considered in the determination of BAT for an individual installation.

Table 4.1: Information for each technique described in this chapter

Heading within the sections
Description
Technical description
Achieved environmental benefits
Environmental performance and operational data
Cross-media effects
Technical considerations relevant to applicability
Economics
Driving force for implementation
Example plants
Reference literature

4.1 Mercury cell plants

4.1.1 Techniques to reduce emissions of mercury and to reduce the generation of waste contaminated with mercury

Given that the mercury cell technique cannot be considered BAT under any circumstances, techniques to reduce mercury emissions, to reduce the mercury content of products and to reduce the generation of waste contaminated with mercury **during normal plant operation** are not described in Chapter 4. This information can be found in Annex 8.2.

However, techniques to reduce mercury emissions and to reduce the generation of waste contaminated with mercury **during decommissioning** are described in Section 4.1.3.

4.1.2 Conversion of mercury cell plants to membrane cell plants

Description

This technique consists in converting mercury cell plants to membrane cell plants. A conversion to the membrane cell technique includes a change of electrolyzers, additional brine purification, additional brine dechlorination, inclusion of a cell room caustic soda recirculation system and a change of transformers and rectifiers. In most cases, a caustic concentration unit is also added, and sometimes transformers/rectifiers are replaced and polarisation rectifiers are added.

Technical description

To realise the conversion, technical changes are required, the extent of which depend on the existing situation. Some plants have been completely converted, but there are also examples of partial conversion. Figure 4.1 shows the main changes that need to be carried out to an existing plant when converting from the mercury cell technique to the membrane cell technique.

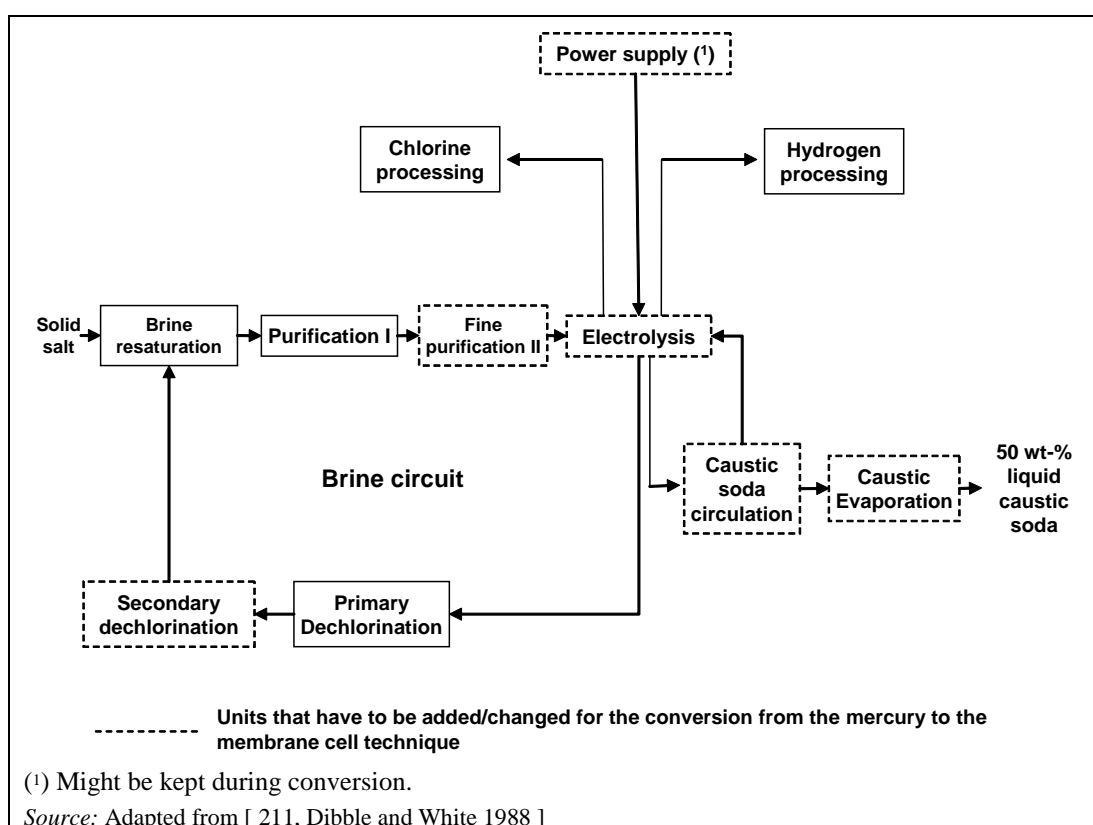

Figure 4.1: Main changes for the conversion of a mercury cell plant to a membrane cell plant

The changes to an existing plant when converting from the mercury to the membrane cell technique include:

1. The brine system

The main concern is the purity of the brine feed to the existing cell room system. As mentioned in Section 2.5.3, membrane cells need purer brine than mercury cells. Practical experience has shown that the mercury brine system can be reused after a careful cleaning of the whole system [211, Dibble and White 1988].

For good performance of the membrane cells, a secondary brine purification step must be added, usually using ion-exchange units. In most cases, it is also necessary to add a polishing filtration step before secondary brine purification, to remove particles from the brine [232, Euro Chlor 2010]. In addition, the construction materials for the piping (e.g. rubber lined steel, plastic materials, gaskets) situated between the ion-exchange columns and the electrolysis cells must, in most cases, be replaced by compatible materials, in order to avoid brine recontamination with metals, calcium/magnesium or other impurities [211, Dibble and White 1988], [333, Euro Chlor 2012].

Additional brine treatment units to remove or reduce the levels of sulphate, chlorate and iodine may be necessary, depending on the site [232, Euro Chlor 2010].

A new high-performance brine dechlorination facility is required to reduce the residual chlorine to levels below those which could deactivate the ion-exchange resins of the secondary brine purification step. Generally, chemical reduction using sodium sulphite, catalytic reduction, or activated carbon adsorption is used, depending on the type of salt and the overall economics [211, Dibble and White 1988].

There is a difference in the water balance between the brine circuits of mercury and membrane cell plants (Section 4.3.2.3.6). There is also a difference in mass flowrates, the brine recirculation rate being higher in mercury cell plants than in membrane cell plants at comparable capacities (Section 2.4.1). Both the water balance and the mass flowrates need to be taken into account in any conversion.

Very pure hydrochloric acid (HCl) is needed for brine acidification and an HCl production unit (H_2/Cl_2 burner) might need to be installed. Some HCl is consumed if chlorate levels in the brine are reduced by acidification (Section 4.3.6.4.2) or acidic reduction (Section 4.3.6.4.3) [232, Euro Chlor 2010].

2. The cell room building

It is reported that existing cell room buildings can be reused to accommodate membrane cell electrolyzers. Space saving makes it theoretically possible to install up to 400 % more capacity in an existing building. However, a clean space is needed for the membrane cells. The decision to reuse an existing building will depend on [211, Dibble and White 1988]:

- the condition of the existing building;
- the availability of space for a new cell room;
- the acceptability of reduced production rates during the construction period.

Some old cell room buildings may be in poor condition and this may justify total replacement. Environmental concerns may also lead to the construction of a new building. This particularly applies to mercury contamination of existing concrete structures, where some emissions will continue even after replacement of the mercury cells [211, Dibble and White 1988]. In the conversion of the mercury cell plant of Associated Octel in Ellesmere Port (United Kingdom),

the existing cell room was kept, but the preparation of the floor took eight weeks for the removal of the old concrete cell plinths and for filling in holes before resurfacing [225, Lott 1995]. Some chlor-alkali plants have space available close to existing cell rooms. This allows the erection of a new cell room building whilst reusing other plant systems *in situ* [211, Dibble and White 1988]. Some companies, because they have plenty of space, succeed in having the two cell techniques in the same cell room, mercury and membrane, without any problem of contamination of membranes or products [224, Bayer 1998]. The construction of the building should also be able to support the normally higher weight of membrane electrolyzers.

The major advantage of a new building is the ability to minimise production losses during conversion, since construction can take place and the electrolyser system can be installed while production continues in the old building [211, Dibble and White 1988]. In 1997, Borregaard in Norway converted its Sarpsborg mercury cell plant to a membrane cell plant, building a completely new cell room. The total production stoppage reported was seven weeks [227, de Flon 1998]. In another case, the building was reused and production could be maintained during the conversion by operation of other cell rooms elsewhere on the site. The penalty of production loss in this case was not significant, which is not the case if there is only a single cell room [211, Dibble and White 1988].

3. The electrolyzers

The design and operation of the electrolyzers are essentially different and no old parts can be reused.

4. The power supply

In many cases, the transformers and rectifiers are replaced, either because they have reached the end of their life (approximately 30 years) or because their technical characteristics are incompatible with the requirements of new membrane cell electrolyzers. Existing mercury electrolyzers are, with a few exceptions, monopolar (high current, low voltage), while new membrane electrolyzers are bipolar (low current, high voltage) [211, Dibble and White 1988], [232, Euro Chlor 2010]. There are, however also examples of plants that have kept (parts of) the power supply during the conversion to the bipolar membrane cell technique, such as Donau Chemie in Brückl (Austria), Electroquímica de Hernani in Hernani (Spain) and Ercros in Sabiñánigo (Spain) [226, Schindler 2000], [235, ANE 2010].

In most cases, polarisation rectifiers also have to be added [333, Euro Chlor 2012].

5. Gas treatment facilities

Chlorine and hydrogen collection and treatment are not essentially different in membrane and mercury cells. Process steps to remove mercury are no longer needed, except for a certain period of time for the hydrogen system due to residual mercury left in the equipment, even after cleaning it. The main concern for the new cell room is pressure control of the gases. The membrane cell technique requires a steady differential pressure of hydrogen over chlorine. This means that a differential pressure controller must be added to the existing control system [211, Dibble and White 1988].

The chlorine and hydrogen gases leave the cell at higher temperatures than with the mercury cell technique. The gases are saturated with water vapour and therefore the loading on gas coolers will be higher, as will the volume of resulting condensate. In addition, the primary cooling system for hydrogen is usually part of the mercury cells. New cooling equipment is therefore needed in most cases [232, Euro Chlor 2010].

Chlorine from membrane cells contains more oxygen, which for some applications needs to be removed. For this purpose, liquefaction, followed by subsequent evaporation of liquid chlorine is necessary. Larger liquefaction units than those normally in operation are therefore required for these applications.

6. Caustic treatment

The mercury cell technique produces 50 wt-% caustic soda. Membrane cells require a recirculating system with associated heat exchange and dilution to produce 33 wt-% caustic soda. Usually, more concentrated caustic soda is needed (50 wt-%), requiring the use of an evaporator system [211, Dibble and White 1988]. These changes usually require an extension of the cooling water circuit and steam production [232, Euro Chlor 2010].

7. Process piping

The reuse of existing process piping is not appropriate when converting to the membrane cell technique, as the physical location is often very different from that required by membrane electrolyzers. The existing piping may also be made of material unsuitable for use with membrane electrolyzers [211, Dibble and White 1988].

An example of a conversion is the Borregaard chlor-alkali plant in Sarpsborg (Norway). Data are summarised in Table 4.2.

Table 4.2: Data from the conversion of the Borregaard mercury cell plant in Sarpsborg (Norway) to the membrane cell technique

<p>Context of the old production units:</p> <ul style="list-style-type: none"> • cell room built in 1949: 3 floors, 122 cells; • mercury emissions to air: 1.4 g/t chlorine capacity; • mercury emissions to water (ion exchange): 0.25 g/t chlorine capacity. <p>Driving forces for conversion:</p> <ul style="list-style-type: none"> • demand from the Norwegian authorities to switch to a mercury-free technique; • demand for higher production of sodium hydroxide and wish to lower operating costs. <p>The conversion:</p> <ul style="list-style-type: none"> • decision made to convert: autumn 1995; • conversion carried out: autumn 1997; • downtime: 7 weeks. <p>Characteristics of new plant:</p> <ul style="list-style-type: none"> • chlorine capacity 40 kt/yr; • electrolyser: bipolar, 4 electrolysers, each 75 cells, 4.35 kA/m²; • membrane area: 2.88 m² per cell. <p>Reused equipment:</p> <ul style="list-style-type: none"> • rectifiers; • hydrogen treatment and HCl production units; • chlorine compression and liquefaction section. <p>New equipment:</p> <ul style="list-style-type: none"> • cell room for electrolysers: the existing building was considered old and mercury-contaminated; • electrolysis section; • brine circuit: brine filtration unit, ion-exchange unit, brine dechlorination unit; • sodium hydroxide recirculation unit and evaporation system; • chlorine gas drying and absorption unit; • power supply and wiring (excluding rectifiers); • pumps, instruments and piping. <p>Cost of conversion:</p> <ul style="list-style-type: none"> • total cost of conversion was about NOK 210 million (EUR 26.6 million in October 1997), corresponding to approximately EUR 665/t chlorine capacity. This figure includes EUR 2.4 million for the clean-up of the old plant and the storage of mercury-contaminated waste but excludes the clean-up of soil pollution. <p>Economic benefits:</p> <ul style="list-style-type: none"> • electricity: 30 % reduced per tonne 100 % NaOH produced; • personnel: 25 % reduced; • some mercury sold for batteries, instruments and to mercury cell plants; • return on investment: five years (depending on the caustic market). <p>Decommissioning:</p> <ul style="list-style-type: none"> • no clean-up of mercury-contaminated soil; • monitoring of mercury emissions to air from old cell room; • construction of a sealed disposal facility for mercury-contaminated wastes: building volume 1 800 m³, 3 special membranes with sand filter seals in between. The bunker is ventilated and the vented air led through a carbon filter. The majority of the waste (about 55 %) was mercury-contaminated process equipment (steel and rubber lined steel); • 95 tonnes of mercury drained from the cells. <p>Source: [227, de Flon 1998]</p>
--

Achieved environmental benefits

The achieved environmental benefits of this technique include:

- prevention of mercury emissions;
- prevention of the generation of wastes contaminated with mercury;
- reduction of energy consumption.

Environmental performance and operational data

Table 4.3 provides examples of reported electricity savings due to conversion to the membrane cell technique.

Table 4.3: Electricity savings due to conversion to the membrane cell technique in different chlor-alkali plants worldwide

Company	Location	Year of conversion	Electricity saving [Reference]
Associated Octel	Ellesmere Port (United Kingdom)	1993	18 % [225, Lott 1995]
Borregaard	Sarpsborg (Norway)	1997	30 % [227, de Flon 1998]
Olin Chemicals	Niagara Falls, New York (United States)	1990	25 % [229, Oceana 2007]
Pioneer	St. Gabriel, Louisiana (United States)	2008	29 % [229, Oceana 2007]
PPG	Beauharnois (Canada)	1990	35 % [229, Oceana 2007]
PPG	Lake Charles, Louisiana (United States)	2007	25 % [228, PPG 2007]
Travancore Cochin Chemicals	Kochi (India)	2006	37 % [229, Oceana 2007]
Westlake Chemicals	Calvert City, Kentucky (United States)	2002	25 % [229, Oceana 2007]

The electricity consumption of mercury cell plants in the EU-27 and EFTA countries for electrolysis ranges from approximately 3 000 to approximately 4 400 AC kWh/t Cl₂ produced, the median being approximately 3 400 AC kWh/t Cl₂ produced (Section 3.3.4.3.2). In 2011, the electricity consumption of new high-performance bipolar membrane electrolyzers at 6 kA/m² was approximately 2 400 AC kWh/t Cl₂ produced (Section 4.3.2.3.1). From these data, electricity savings upon conversion can be calculated in the range of 20 % to 45 %, the median being 29 %. However, the total reduction of energy consumption is lower if steam is required to bring the caustic produced to the commercial concentration of 50 wt-% and/or if additional chlorine purification is required (liquefaction and evaporation).

Cross-media effects

Significant amounts of raw materials and energy are required for the installation of the new equipment.

The caustic produced by the membrane cells (33 wt-%) usually has to be concentrated to 50 wt-%, resulting in additional steam consumption.

During conversion, a temporary increase in mercury emissions to the environment can be expected, due to the demolition of the old cells. Also, substantial amounts of mercury-contaminated waste are generated in the decommissioning process (Section 4.1.3).

Technical considerations relevant to applicability

There are no technical restrictions to the applicability of this technique. The changes required for an existing mercury cell plant are described above.

The concentrations of chloride and chlorate are generally higher in caustic from membrane cell plants than in caustic from mercury cell plants (Table 2.1 and Section 2.9). Low salt concentrations in caustic potash were reported to be essential for some minor applications (e.g. electrolytes in batteries and fuel cells, manufacturing of solar cells, photographic chemicals and other special potassium chemicals). In 2010, Euro Chlor reported that some manufacturers in EU Member States had concerns regarding the marketability of caustic potash produced in membrane cells for the aforementioned applications [42, Euro Chlor 2010]. However, other manufacturers report that in practice, given the same raw material inputs, once stable operating conditions have been reached, membrane-based caustic potash can adequately serve any market that mercury-based caustic potash does [236, EIPPCB 2011].

Economics

Influencing factors

The investment costs of a conversion depend on several factors, leading to large differences from one plant to another. These variations are caused by differences in [232, Euro Chlor 2010]:

1. Scope of the conversion

The most important factor is the possibility of reusing a significant part of the old mercury cell plant. Depending on the age of the plant, it may or may not be technically feasible and convenient to recuperate some part of the plant (see Technical Description). Even if it is technically feasible, it may be inconvenient from the business point of view if the duration of the shutdown needed for the conversion is not acceptable for the customers. Furthermore, the new membrane cell plant may have a different capacity than the original one. Indeed, some companies may take the opportunity of the conversion to increase or reduce the production capacity of the plant, and in this case the reuse of existing equipment may become inconvenient or impossible [232, Euro Chlor 2010].

2. Current density

The selection of the current density is made by balancing the operational costs (decreasing the current density leads to lower electricity consumption) and the investment costs (the selection of a lower current density implies more electrolyzers to produce the same amount of chlorine) (Section 4.3.2.3.1). As shown in Table 4.15 for a plant with a chlorine production of 100 kt/yr, an increase in the current density from 5 to 6 kA/m² leads to a 17 % decrease in the number of cells, while a decrease in the current density from 5 to 4 kA/m² leads to a 25 % increase in the number of cells. An increase in the number of cells results in an increase in the number of electrolyzers (and their associated piping, valves, instruments, grating, busbars) and the size of the cell room. However, the investment costs for the brine recirculation and the caustic concentration are not affected by the selection of the current density [232, Euro Chlor 2010].

3. Market conditions

The costs of a conversion are affected by several market conditions. The membrane cell technique requires the use of some expensive metals such as nickel (for cathodes and caustic concentration), titanium (for anodes, anode coatings, and anodic compartments), ruthenium (for anode and cathode coatings), iridium (for anode coatings) and copper (for electric transformers). The price of nickel usually has the biggest impact. A plant with a chlorine capacity of 100 kt/yr needs approximately 100 t of nickel. For such a plant, the difference between low- and high-priced nickel during the first decade of the 21st century (EUR 5 000–40 000/t Ni) would therefore result in an absolute difference in investment costs of EUR 3.5 million. Price

fluctuations for titanium or copper can also be up to EUR 1 million for the same plant. In addition, the prices for electrolysers and membranes depend on the currency exchange rates (GBP, USD and JPY versus EUR), while the costs for construction and engineering depend on the order book of the companies [232, Euro Chlor 2010].

4. Plant size

An increase in the plant size leads to reduced relative investment costs, which can be calculated using the following equation [232, Euro Chlor 2010]:

$$\text{Equation 2: } P_C = (100/C)^{0.3} \times P_{100}$$

where:

- P_{100} : investment costs in EUR/t annual chlorine capacity for a plant with a chlorine capacity of 100 kt/yr;
 C : chlorine capacity in kt/yr;
 P_C : investment costs in EUR/t annual chlorine capacity for a plant with a chlorine capacity of C .

Investment costs of EUR 400/t Cl_2 capacity for a plant with a chlorine capacity of 100 kt/yr will therefore become EUR 492/t Cl_2 capacity for a plant with a chlorine capacity of 50 kt/yr and EUR 325/t Cl_2 capacity for a plant with a chlorine capacity of 200 kt/yr.

Investment costs

Table 4.4 gives ranges of investment costs for the cell room, depending on the current density. The ranges for electrolysers and ancillaries depend on the markets for construction materials, while those for buildings and the electricity supply depend on the possibility of reusing existing facilities. Overall, investment costs may range from EUR 58 to 284/t annual Cl_2 capacity [232, Euro Chlor 2010].

Table 4.4: Investment costs for the cell room conversion of a mercury cell plant with a final chlorine capacity of 100 kt/yr

Cost object	Current density					
	4 kA/m ²		5 kA/m ²		6 kA/m ²	
	Investment costs in EUR/t annual Cl_2 capacity					
	Minimum	Maximum	Minimum	Maximum	Minimum	Maximum
Electrolysers	53	106	43	85	36	71
Ancillaries	33	43	26	34	22	28
Building	NI	14	NI	11	NI	9
Electricity supply	NI	121	NI	97	NI	81
Total cell room	86	284	69	227	58	189
NB: NI = no information provided.						
Source: [232, Euro Chlor 2010]						

The investment costs for the conversion of other parts of an installation do not depend on the design current density but mostly on the production capacity. For the conversion of a mercury cell plant with a chlorine capacity of 100 kt/yr and a design current density of 5 kA/m², investment costs range from EUR 214 to 553/t annual Cl₂ capacity (Table 4.5). Apart from the cell room, the total costs depend on the necessity for additional brine treatment steps and the markets for construction materials and services. Considering a design current density variation of 4–6 kA/m², the total investment cost range expands to EUR 203–610/t annual Cl₂ capacity. By comparison, the costs for a completely new membrane cell plant are estimated to be approximately EUR 1 000/t annual Cl₂ capacity. The investment costs for a conversion thus represent 20–60 % of the investment costs of a new plant [232, Euro Chlor 2010].

Table 4.5: Investment costs for the conversion of a mercury cell plant with a chlorine capacity of 100 kt/yr and a design current density of 5 kA/m²

Cost object	Investment costs in EUR/t annual Cl ₂ capacity ⁽¹⁾	
	Minimum	Maximum
Cell room and electricity supply (5 kA/m ²)	69	227
Peripherals (electrolytes circuits)	10	16
Caustic concentration (3 effects)	33	50
Intermediate buffer tank	NI	10
Brine circuit		
Polishing filters	11	15
Hardness removal	14	20
Dechlorination	3	4
Chlorate removal	NI	10
Sulphate removal	NI	15
Chlorine circuit (liquefaction)	NI	27
Hydrogen cooling	NI	2
Cooling water	NI	7
Total for equipment and installation	140	403
Engineering	36	51
Pro-rata and start-up costs	10	28
Miscellaneous (10 %)	18	45
Escalation and financial costs	10	26
Total conversion	214	553
⁽¹⁾ Costs for decommissioning of the old mercury cell plant and costs for replacement or refurbishment of other equipment are not included.		
NB: NI = no information provided.		
Source: [232, Euro Chlor 2010]		

Table 4.6 lists examples of investment costs ranging from EUR 190 to 670/t annual Cl₂ capacity for conversions carried out between 1992 and 2009.

Table 4.6: Comparison of reported conversion costs of mercury cell plants

Company, location, year of conversion	Chlorine capacity in kt/yr	Investment costs in original currency	Investment costs in EUR (currency conversion date)	Investment costs in EUR/t annual Cl ₂ capacity	Remarks [Reference]
Donau Chemie in Brüchl (Austria), 1999	60	ATS 200 M	14.5 M (fixed EMU conversion rate)	242	Power supply and cell room building reused; non-conversion costs included such as downstream modifications and increased capacity of HCl and bleach production; site clean-up not included [226, Schindler 2000], [234, UBA AT 1998].
		ATS 160 M	11.6 M (fixed EMU conversion rate)	194	Pure conversion costs; estimated waste disposal costs included [226, Schindler 2000], [234, UBA AT 1998].
Bayer in Dormagen (Germany), 1999	300	DEM 240 M	122.7 M (fixed EMU conversion rate)	409	Total costs including engineering and construction (new equipment: DEM 170 M); cell room building, brine filtration, H ₂ and Cl ₂ gas treatment facilities and compressors reused; dismantling of most Hg cells not included [230, Schubert 2000], [231, Chemie Produktion 2000].
Borregaard in Sarpsborg (Norway), 1997	40	NOK 210 M	26.6 M (October 1997)	665	Rectifiers reused; new cell room; new brine circuit; construction and building of a landfill; non-conversion costs included [227, de Flon 1998].
Electroquímica de Hernani in Hernani (Spain), 2002	15	EUR 6.12 M	EUR 6.12 M	408	Hydrogen treatment and chlorine gas drying, compression, liquefaction and absorption unit reused; new cell room, new brine circuit, new rectifiers, new caustic concentration; decontamination included, soil clean-up not included [235, ANE 2010].
Ercros in Sabiñánigo (Spain), 2009	30	EUR 20 M	EUR 20 M	667	Cell room, rectifiers, hydrogen treatment and chlorine absorption reused. New chlorine gas drying, new chlorine compression and liquefaction, new brine circuit, new caustic concentration; decontamination included, soil clean-up not included [235, ANE 2010].
Associated Octel in Ellesmere Port (United Kingdom), 1992	40	GBP 11.6 M	14.5 M (January 1995)	362.5	'Old' costs (no previous practical experience); includes the clean-up and disposal of the contaminated parts of the plant (excluding soil) [225, Lott 1995].

Generally, conversion costs of more than EUR 600/t annual Cl₂ capacity also include costs not directly related to the conversion, such as landfill construction, site clean-up, capacity increase, etc. Costs between EUR 400 and 600/t annual Cl₂ capacity generally include new cell room, power supply, waste disposal, downstream modifications, etc. Reported minimum conversion costs range from below EUR 200 to 400/t annual Cl₂ capacity and generally include some costs for waste disposal and/or clean-up of contaminated parts.

The cost of loss of production may play a significant part in conversion economics. There are techniques, such as prefabrication, to minimise downtime. The Donau Chemie plant in Brückl (Austria) converted in summer 1999 and the mercury cells were running at 80 % production rate while the membrane cells were installed. During the change of cells and system components, the plant was shut down from Monday night to Friday (4 days) [226, Schindler 2000], [234, UBA AT 1998].

A gradual conversion was carried out at the Bayer site in Uerdingen (Germany) taking advantage of an increased demand for chlorine. The same building could be used and no concentration plant or gas treatment facilities were needed. The production from the membrane cell unit was increased progressively, switching off mercury cells and balancing the demand between the two techniques when it was possible [224, Bayer 1998]. However, industry reports that generally a step by step conversion is not economically attractive compared to a complete conversion, mainly because of cross-contamination of mercury into new equipment and the probable need for adaptations to the power supply.

Economic benefits

Economic benefits resulting from the conversion of mercury cells to membrane cells stem from [97, Concorde 2006], [225, Lott 1995], [227, de Flon 1998]:

- reduced energy consumption;
- reduced need for maintenance, reduced workforce;
- cost savings from mercury emission abatement and monitoring, treatment and disposal of waste contaminated with mercury and medical supervision/treatment of the workforce.

Table 4.7 provides an estimation of annual economic benefits resulting from the conversion of a mercury cell plant. Most of the savings result from reduced energy consumption, while the non-energy related benefits in this example account for 15–21 %. A part of these savings is offset, mainly by the increase in steam consumption due to caustic concentration, but also by the higher costs for chemicals required to operate a membrane cell plant [308, UNEP 2012].

Table 4.7: Estimation of economic benefits resulting from the conversion of a mercury cell plant with a chlorine capacity of 100 kt/yr

Cost object	Savings due to conversion in EUR/t chlorine produced
Energy consumption	45 ⁽¹⁾
Treatment of waste contaminated with mercury (recycling, retorting, transporting, storing and/or disposing)	3–5 ⁽²⁾
Removal of mercury from waste water	2–3
Removal of mercury from waste gas and products, monitoring of mercury	< 1
Labour costs (reduced need for maintenance)	2
Labour costs (reduced need for mercury abatement, monitoring, reporting and medical supervision)	1
Total	53–57
⁽¹⁾ Depending on actual reduction in electricity consumption and electricity prices. Savings of EUR 45/t chlorine produced could result from a reduced energy consumption of 1.0 MWh/t chlorine produced and energy costs of EUR 45/MWh. ⁽²⁾ Depending on the amount of waste generated and the specific costs (per kg) to treat this waste. Savings of EUR 5/t chlorine produced could result from a waste quantity of 50 t/yr (Table 3.37 and Table 3.38) a chlorine production of 100 kt/yr and waste treatment costs of EUR 10/kg waste. <i>Source: [97, Concorde 2006]</i>	

Payback time

A cost calculation of simple payback times for the replacement of an electrolysis unit, depending on the investment and electricity costs, as well as the electricity savings, is given in Section 4.3.2.3.1. The resulting 10 years payback (electricity price: EUR 50/MWh; electricity savings: 1.0 MWh/t chlorine produced; investment costs: EUR 500/t annual chlorine capacity) for the conversion of a mercury cell plant is roughly in line with payback times reported elsewhere: typically 10 years [97, Concorde 2006] or 11.6–20.4 years [308, UNEP 2012]. In some cases, payback times are shorter, one example being the Borregaard plant in Sarpsborg (Norway) with a reported payback time of five years [227, de Flon 1998], [309, Toxics Links 2012].

As a reference for the chemical industry, the average requested payback time for investments in energy-saving equipment is approximately three years. Only for particular projects that may offer additional advantages, such as a green image or the achievement of CO₂ reduction targets, may a payback time of more than five years be accepted [114, Delfrate and Schmitt 2010]. An investment in conversion is usually not attractive to an industry that typically seeks a payback time of less than five years (despite an expected plant lifetime of over 40 years), unless other economic factors come into play, such as changing markets, industry restructuring, plant ageing or lower-than-average conversion costs [97, Concorde 2006]. Another economic incentive could be state subsidies, as in the case of the Altair Chimica plant in Volterra and the Solvay plant in Rosignano (both in Italy) [239, COM 2005].

According to Euro Chlor, conversions are therefore only sufficiently profitable in special circumstances, such as the need for increased capacity, or high energy or maintenance costs when the plant is reaching the end of its natural life. Most of the mercury cells were installed up to the mid-1970s and economic plant lifetimes can be in the range of 40–60 years, depending on operating and maintenance conditions [237, Lindley 1997].

In the EU-27 and EFTA countries, the cost of electrical energy is very dependent on the basic source of energy and the type of contracts negotiated with suppliers, but the relative differences between countries and regions remain. The special circumstances making a mercury cell plant economical can change if the price of electrical energy increases sharply; in this case a conversion to the membrane cell technique can become more economically attractive.

Effect on downstream production

Most of the chlorine produced is used as a chemical intermediate, either internally or by other companies. A key consideration, therefore, is the downtime associated with the conversion and the impact on the production of downstream products such as PVC. Caustic users will also be affected by restrictions in chlor-alkali production.

Driving force for implementation

The driving forces for implementation of this technique include:

- environmental legislation;
- reduction of costs related to energy consumption;
- capacity increase of an existing plant.

Example plants

More than 50 chlor-alkali plants worldwide have been converted to the membrane cell technique since the beginning of the 1980s [229, Oceana 2007]. Example plants are listed in Table 4.6.

Reference literature

[97, Concorde 2006], [114, Delfrate and Schmitt 2010], [211, Dibble and White 1988], [224, Bayer 1998], [225, Lott 1995], [226, Schindler 2000], [227, de Flon 1998], [228, PPG 2007], [229, Oceana 2007], [230, Schubert 2000], [231, Chemie Produktion 2000], [232, Euro Chlor 2010], [234, UBA AT 1998], [235, ANE 2010], [236, EIPPCB 2011], [237, Lindley 1997], [308, UNEP 2012], [309, Toxics Links 2012], [333, Euro Chlor 2012]

4.1.3 Decommissioning

4.1.3.1 Decommissioning plan

Description

This technique consists in elaborating and implementing a decommissioning plan for mercury cell plants. The implementing phase includes setting up a working area, emptying of the cells and handling of metallic mercury, as well as dismantling, demolition and decontamination of equipment and buildings. Finally, the residual wastes may be stored for a short time on site, transported, and further treated before being disposed of.

Technical description

1. Elaboration of the decommissioning plan

The decommissioning plan is usually elaborated by a team containing staff from the management of the chlor-alkali plant. The inclusion of external contractors in the team from the beginning has proven beneficial. The plan may be shared with the permitting authorities prior to sending a formal application. The plan usually addresses [94, Euro Chlor 2009]:

- provision of procedures and instructions for all stages of implementation, including health and safety aspects;
- provision of a detailed training and supervision programme for personnel with no experience in mercury handling;
- provision of a suitable working area;
- provision of equipment for mercury handling (e.g. containers, cranes, forklift trucks, devices to fill containers);
- determination of the quantity of metallic mercury to be recovered;

- estimation of the quantity of waste to be disposed of and of the mercury contamination therein;
- monitoring of mercury in air, water and waste, including for an appropriate time after the finalisation of the decommissioning or conversion;
- health checks and biological mercury monitoring for staff;
- planning of transport, storage and disposal.

2. Setting-up of a working area

The working area for dismantling, demolition and decontamination of equipment could be the basement of the existing cell room or a decontamination pad erected for the decommissioning. Suitable working areas are [94, Euro Chlor 2009]:

- well-defined, if necessary surrounded by kerbing;
- covered with a roof to exclude rainwater;
- equipped with a smooth, sloped, impervious floor to direct mercury spills to a collection sump;
- well-lit to enable easy identification and clean-up of spills;
- free of obstructions and debris that may absorb mercury and/or hinder the clean-up of spills (e.g. wooden pallets);
- equipped with a water supply for washing;
- equipped with aspiration equipment with activated carbon filters to rapidly clean up spills;
- connected to a waste water treatment system.

3. Emptying of the cells and handling of metallic mercury

In general, emissions of mercury can be reduced by minimising its handling. For this reason, it is advantageous to carry out all recovery, cleaning and filling operations at the chlor-alkali plant which, in addition, is likely to have an adequate infrastructure for this purpose [222, Euro Chlor 2007].

Directive 2011/97/EU sets requirements for containers used for the purpose of temporary storage for more than one year of metallic mercury at landfills. Containers shall be corrosion- and shock-resistant. Welds shall therefore be avoided. The maximum filling ratio of the container shall be 80 % by volume to ensure that sufficient ullage is available and neither leakage nor permanent distortion of the container can occur as a result of an expansion of the liquid due to high temperature. The containers shall comply in particular with the following specifications [282, Directive 2011/97/EU 2011]:

- container material: carbon steel (ASTM A36 minimum) or stainless steel (AISI 304, 316L);
- containers shall be gas and liquid tight;
- the outer side of the container shall be resistant against the storage conditions;
- the design type of the container shall successfully pass the drop test and the leakproofness tests described in Chapters 6.1.5.3 and 6.1.5.4 of the UN Recommendations on the Transport of Dangerous Goods, Manual of Tests and Criteria.

A suitable procedure for emptying of the cells and transferring metallic mercury to containers includes [94, Euro Chlor 2009]:

- keeping the system closed if possible, to reduce mercury emissions;
- washing of mercury to remove residual sodium to avoid the risk of hydrogen formation (e.g. by circulating the mercury of each individual cell with wash water until the exit wash water stabilises at pH 7 ± 0.5 and the specific gravity at 1.0);

- using gravity transfer, if possible;
- checking that the mercury is not contaminated and, when necessary, using filtration or decantation to remove solid impurities such as rust and rubber particles;
- avoiding the transfer of other liquids, such as water, into the mercury containers;
- filling the containers to ≤ 80 % of their volumetric capacity to avoid overpressures;
- hermetically sealing the containers after filling;
- weighing and labelling the containers according to relevant legislation;
- washing of the empty cells with an alkaline hydrogen peroxide solution and water, followed by filling with water to reduce mercury emissions until the cells are dismantled.

4. Dismantling, demolition and decontamination

Techniques which have been recommended to reduce mercury emissions during dismantling, demolition and decontamination include [94, Euro Chlor 2009], [274, Ancery 2011], [276, French Ministry 2010]:

- inclusion of some of the staff experienced in running the former plant;
- replacement of hot cutting of equipment by cold cutting, if possible;
- taking precautions against the dispersion of mercury droplets if high pressure is used for the cleaning of surfaces (e.g. confined areas with treatment of waste gases);
- storage of contaminated equipment in suitable areas (e.g. steel can be highly contaminated with mercury which can sweat out during storage);
- frequent washing of the floor of the working area;
- rapid clean-up of mercury spills by using aspiration equipment with activated carbon filters;
- accounting of waste streams (origin, mass, volume, mercury concentration and destination).

In general, mercury-contaminated waste is, as much as possible, separated from non-contaminated waste. Decontamination aims at concentrating mercury into a smaller amount of waste, preferentially as metallic mercury. The techniques used are the same as the ones used in mercury cell plants in production but some adaptations may be required due to the much higher quantities handled in a short period of time [94, Euro Chlor 2009].

Several treatment techniques for solid waste are used [87, Euro Chlor 2006], [94, Euro Chlor 2009]:

- Mechanical and physical treatments: These include washing with water (with or without pressure), ultrasonic vibration, and vacuum cleaners with appropriate adsorption or condensation systems. Mechanical and physical treatments are suitable if significant quantities of metallic mercury are present.
- Chemical treatment: This includes treatment with hypochlorite, chlorinated brine or hydrogen peroxide. The liquid streams are treated as described below.
- Thermal treatment: Distillation/retorting is carried out in specially designed units. The mercury is recovered as metallic mercury.

The choice of the appropriate decontamination technique depends on the location of the mercury, its concentration, and its chemical state for each category of material. For example, ultrasonic vibration with recovery of the released mercury is effective with certain types of pore-sized activated carbon but not with others. Retorting is technically difficult or uneconomic for wastes with high water or organic content, low mercury content, or with mercury in a state (e.g. mercury sulphide) that is inappropriate for this technique. Retorting is used by many mercury cell plants during normal operation. Some of these plants have their own retorting unit which can be used during decommissioning, while others use the services of an external retorting company [59, Euro Chlor 2010], [94, Euro Chlor 2009].

After appropriate decontamination, materials such as steel structures, copper or aluminium busbars can often be recycled as raw materials [94, Euro Chlor 2009]. In the case of a conversion to the membrane cell technique, the brine system and the processing systems for chlorine and hydrogen can often be reused after appropriate decontamination (Section 4.1.2).

Table 4.8 provides an overview of contaminated solid materials arising during decommissioning and possible decontamination techniques.

Table 4.8: Overview of contaminated solid materials arising during decommissioning and possible decontamination techniques

Material	Typical Hg content in wt-%	Remarks	Possible decontamination technique		
			Mechanical and physical treatment	Chemical treatment	Thermal treatment
Sludge from storage tanks and sumps	10–30	Wet	Yes	No	Yes
Sludge from settling catch pits, drains, etc.	2–80	Wet	Yes	No	Yes
Sulphurised or iodised activated carbon from hydrogen purification	10–20	Dry	Yes ⁽¹⁾	Yes	No
Activated carbon from caustic filters	≤ 40	Wet	Yes	No	Yes
Graphite from decomposers	2	Porous	Yes	Yes	Yes
Rubber/packing	variable	No remarks	Yes	Yes	No
Brickwork/concrete	0.01–0.1	Dry	Yes	Yes	Yes
Ebonite-lined cell components (anodes covers, end-boxes, side walls, pipework)	variable	Inhomogeneous contamination	Yes	Yes	No
Steel (cells, decomposers, baffles, H ₂ coolers, base plates, Hg pumps, pipework)	0.001–1	Surface contamination	Yes	Yes	Yes
Plastic equipment	< 0.1	Surface contamination	Yes ⁽²⁾	No	No
Copper conductors	0.04	Surface contamination	Yes	No	Yes ⁽³⁾
Cell sealant (layers concrete)	0.01	No remarks	Yes ⁽¹⁾	No	No
Asphalt	1–20	Inhomogeneous contamination	Yes	No	No
Concrete and subfloor	variable	Inhomogeneous contamination	Yes	No	Yes
Wood	variable	No remarks	Yes	No	No
Soil	variable	Inhomogeneous contamination	Yes	No	Yes
Decomposer lagging (thermal insulation)	0.03	No remarks	No treatment before disposal		
Retort residues	≤ 0.1	Dry, porous			
Wooden floorboards	0.05–0.08	Inhomogeneous contamination			

⁽¹⁾ Washing with water is not effective.
⁽²⁾ Only washing with water is effective.
⁽³⁾ For flexible connections made of several copper sheets.

Source: [94, Euro Chlor 2009]

When high concentrations of mercury are expected to be present in the workspace atmosphere, the working area is confined and the ventilation air is treated (e.g. for high-pressure washing of contaminated materials) [274, Ancery 2011], [276, French Ministry 2010]. Techniques to remove mercury from waste gases include [1, Ullmann's 2006], [87, Euro Chlor 2006]:

- adsorption on iodised or sulphurised activated carbon;
- scrubbing with hypochlorite or chlorinated brine to form mercury(II) chloride;
- adding chlorine to form dimercyry dichloride (calomel), which is then collected on a solid substrate such as rock salt in a packed column.

Techniques to remove mercury from waste water will generally include a first settling step to remove large mercury droplets. For the second step, three options are generally employed [91, Euro Chlor 2011]:

- Use of oxidising agents such as hypochlorite, chlorine or hydrogen peroxide to fully convert mercury into its oxidised form, with subsequent removal by ion-exchange resins. The regeneration of the resins results in a liquid which requires further treatment.
- Use of oxidising agents such as hypochlorite, chlorine or hydrogen peroxide to fully convert mercury into its oxidised form, with subsequent precipitation as mercury sulphide, followed by filtration. The precipitate is treated as solid waste.
- Use of reducing agents such as hydroxylamine to fully convert mercury into its elemental form, with subsequent removal by coalescence and recovery of metallic mercury, followed by adsorption on activated carbon.

Another technique which uses bacteria to reduce ionic mercury into metallic mercury before adsorption on activated carbon was tested on an industrial scale by two plants, of which one still used the technique in 2011 [91, Euro Chlor 2011], [92, Gluszczyk et al. 2007].

Laundry wash water arising from the cleaning of protective equipment is usually treated as mercury-contaminated waste water [91, Euro Chlor 2011].

In some cases, mercury removal from waste water continues after decommissioning, due to residual contamination (e.g. in pipework) [94, Euro Chlor 2009].

Depending on their conditions, buildings can be reused after decontamination. Experience has shown that if the concrete is in good condition contamination is usually limited to the surface layer. Decontamination can be achieved after removal of all equipment by cleaning the walls, followed by coating or painting to give them an impermeable surface. The renewal of non-structural materials, including the top layer of the concrete floor, may be necessary. Furthermore, cleaning or, if necessary, renewal of the existing waste water collection systems in or around the plant is usually carried out [94, Euro Chlor 2009].

The dismantling of the cell room at the Arkema plant in Saint Auban (France) was carried out in the following sequence [276, French Ministry 2010]:

- Dismantling of the concrete parts and segregation of the obtained gravel due to its mercury content.
- Avoiding the production of dust by spraying water.
- Dismantling of the building structure (in the following order: beams, brick walls, concrete foundation slab and finally roofing). Before dismantling the roof, a liner and a layer of sand were installed to avoid potential leaching.

Table 4.9 lists techniques which can be used to monitor mercury in air, water and waste.

Table 4.9: Techniques for monitoring of mercury in air, water and waste

Environmental Medium	Monitoring method	Standard [Reference]
Air	Manual method for exhaust gases from ducts or chimneys	EN 13211 ⁽¹⁾ [166, CEN 2001]
	Automated measuring systems for flue-gas	EN 14884 ⁽¹⁾ [167, CEN 2005]
	Measurement in workplace air	ISO 17733 ⁽¹⁾ [168, ISO 2004]
	Portable analysers based on UV absorption or change in conductivity of gold film	[184, Euro Chlor 2008]
Water	Atomic absorption spectrometry	EN ISO 12846 [175, CEN 2012]
	Atomic fluorescence spectrometry	EN ISO 17852 [271, CEN 2006]
Waste	Aqua regia digestion	EN 13657 ⁽¹⁾ [177, CEN 2002]
	Microwave-assisted digestion	EN 13656 ⁽¹⁾ [178, CEN 2002]

⁽¹⁾ Standard has to be used in combination with another which measures the respective pollutant in water.

5. Short-term storage of metallic mercury on site

Prior to transport, further treatment and disposal, it may be necessary to store metallic mercury for a short term on site. Suitable storage facilities are [331, Euro Chlor 2011]:

- well-lit;
- weatherproof to avoid corrosion;
- secured against unauthorised access;
- equipped with a floor capable of carrying the heavy weight;
- free of substances that are flammable or may react with mercury;
- equipped with a suitable secondary containment capable of retaining 110 % of the liquid volume of any single container (e.g. metal or plastic spill trays; crack-free, smooth, impervious floor with slopes and gutters leading to a collection sump);
- free of obstructions and debris that may absorb mercury and/or hinder the clean-up of spills (e.g. wooden pallets);
- equipped with aspiration equipment with activated carbon filters to rapidly clean up spills;
- periodically inspected, both visually and with mercury-monitoring equipment.

6. Transport, further treatment and disposal

Transport, further treatment and disposal of waste incurred during decommissioning are outside the scope of this document. Some relevant legislation is mentioned in Section 4.1.3.2.

Achieved environmental benefits

The achieved environmental benefits of this technique include:

- reduction of mercury emissions during decommissioning;
- reduction of the generation of wastes contaminated with mercury during decommissioning.

Environmental performance and operational data

At the Arkema plant in Saint Auban (France), high-pressure washing with water avoided the disposal of 4500 t of metals and plastics in salt mines. In addition, 407 t of copper, 230 t of aluminium and 1 634 t of steel were recycled after decontamination. The high-pressure washing was carried out in a decontamination tent, the ventilation air being treated with activated carbon and the wash water being drained to waste water treatment [276, French Ministry 2010].

The techniques used for mercury removal from waste gases and waste water during decommissioning are the same as the ones used in mercury cell plants during normal plant operation.

Mercury concentrations are typically $\leq 30 \mu\text{g}/\text{m}^3$ in treated waste gases [87, Euro Chlor 2006]. During the decommissioning of the Ercros plant in Sabiñánigo (Spain), the average eight-hour mercury concentration in the atmosphere was always $< 20 \mu\text{g}/\text{m}^3$ [275, ANE 2010].

For waste water, the techniques are generally able to reduce mercury concentrations from more than 10 mg/l to less than 10 $\mu\text{g}/\text{l}$ [91, Euro Chlor 2011]. Biological mercury removal shows higher residual mercury concentrations (typically $< 50 \mu\text{g}/\text{l}$) [91, Euro Chlor 2011], [92, Gluszczyk et al. 2007].

Current emission levels of mercury to water are presented in Table 3.35. The lowest maximum concentration reported was 1.0 $\mu\text{g}/\text{l}$ and the lowest annual average concentration 1.7 $\mu\text{g}/\text{l}$. Taking into account data reported as ranges and annual averages, it can be estimated that mercury emissions from the plants covered by the survey were in 13 % of the cases $\leq 3.0 \mu\text{g}/\text{l}$ during normal operation, in 17 % of the cases $\leq 5.0 \mu\text{g}/\text{l}$, in 22 % of the cases $\leq 10 \mu\text{g}/\text{l}$, in 35 % of the cases $\leq 15 \mu\text{g}/\text{l}$, in 39 % of the cases $\leq 20 \mu\text{g}/\text{l}$ and in 43 % of the cases $\leq 30 \mu\text{g}/\text{l}$ [57, CAK TWG 2012]. Example data from well-performing plants are shown in Table 4.10.

Table 4.10: Example data from mercury cell plants with low mercury emissions to water in the EU-27 in 2008 - 2011

Plant, location	Technique to reduce mercury emissions	Mercury emissions to water		Reference year	Reference conditions
		Concentrations in µg/l ⁽¹⁾	Load in g/t annual Cl ₂ capacity		
AkzoNobel in Ibbenbüren (Germany)	Oxidation with brine, sand filtration, activated carbon filtration, ion exchange	1.68	0.00	2010	Continuous measurement
Bayer in Uerdingen (Germany) ⁽²⁾	NI	< dl-1	0.00	2009	Continuous measurement
INEOS ChlorVinyls in Stenungsund (Sweden)	Reduction with hydrazine, sedimentation, sand filtration and absorption on activated carbon	5–12	0.00	2011	Continuous measurement
INEOS ChlorVinyls in Tessenderlo (Belgium)	Precipitation of HgS and filtration with pre-coated filter	10–15	0.01–0.02	NI	Daily measurement
INEOS ChlorVinyls in Wilhelmshaven (Germany) ⁽³⁾	Precipitation of HgS and filtration	~ 9	0.006–0.008	NI	Continuous measurement
Solvay in Tavaux (France) ⁽²⁾	Precipitation of HgS	1–3	0.00	2009	Daily measurement of 24-hour composite samples
Solvin in Antwerp-Lillo (Belgium) ⁽²⁾	Precipitation of HgS, sedimentation and sand filtration	0.4–13	0.01	2008	Daily measurement of 24-hour composite samples

⁽¹⁾ Data refer to the outlet of the mercury treatment unit.
⁽²⁾ Plant was converted into a membrane cell plant in 2012.
⁽³⁾ Plant was shut down in 2013.
NB: dl = detection limit; NI = no information provided.
Source: [57, CAK TWG 2012], [116, Euro Chlor 2013]

Mercury concentrations in waste water from membrane cell plants that were converted from mercury cell plants are shown in Table 4.11.

Table 4.11: Mercury concentrations in waste water of membrane cell plants that were converted from mercury cell plants

Plant, location	Mercury concentrations in µg/l ⁽¹⁾	Reference year	Reference conditions	Year of conversion
Altair Chimica in Volterra (Italy)	< 5	2009	Measurement once every day	2008
Solvay in Rossignano (Italy)	< dl-3	2009	Measurement twice every month as 24-hour composite sample	2008
Syndial in Assemini (Italy)	< 1-4	2009	NI	before 2005

⁽¹⁾ Data refer to the outlet of the mercury treatment unit.
 NB: dl = detection limit; NI = no information provided.
 Source: [57, CAK TWG 2012]

Cross-media effects

Some raw materials and energy are consumed during decommissioning.

Technical considerations relevant to applicability

Generally, there are no technical restrictions to the applicability of this technique.

Economics

The costs for decommissioning are site-specific. Some examples are given below.

At the Arkema plant in Saint Auban (France), the total costs for decommissioning amounted to EUR 10 million. These costs included EUR 2.5 million for the dismantling of the cells, EUR 2.5 million for the dismantling of the other equipment and the building, as well as EUR 5 million for waste treatment and disposal [276, French Ministry 2010].

At the Borregaard plant in Sarpsborg (Norway), the total quantity of contaminated waste material was estimated at 1 750 m³, of which 50 % was contaminated process equipment, such as steel and rubber lined steel [227, de Flon 1998]. The costs for decommissioning are summarised in Table 4.12.

Table 4.12: Decommissioning costs at the Borregaard mercury cell plant in Sarpsborg (Norway) in 1997

Activity	Costs	
	million NOK 1997	million EUR ⁽¹⁾
Cell room (removal and bottling of mercury, dismantling of equipment, sand washing of walls, floor, ceiling)	3.6	0.5
Dismantling of pipelines and other equipment in cell room	1.9	0.2
Treatment of mercury-contaminated waste (washing, solidification, etc.)	1.5	0.2
Construction and building of landfill	9.0	1.1
Transport and filling into landfill	2.1	0.3
Extra analyses, measurements and safety equipment	0.5	0.06
Total	18.6	2.36

⁽¹⁾ Exchange rate of October 1997.
 Source: [227, de Flon 1998]

At the Chimcomplex plant in Borzești (Romania), the total costs for decommissioning, including equipment cleaning, mercury recovery and building confinement, amounted to EUR 250 000–300 000 [57, CAK TWG 2012].

At the Electroquímica de Hernani plant in Hernani (Spain), the total costs for decommissioning amounted to EUR 120 000, of which EUR 100 000 were related to the disassembling task, and EUR 20 000 were related to external waste management [275, ANE 2010].

The costs for decommissioning of the Ercros plant in Sabiñánigo (Spain) are summarised in Table 4.13.

Table 4.13: Decommissioning costs at the Ercros mercury cell plant in Sabiñánigo (Spain) in 2009

Activity	Costs in EUR
Civil work decontamination areas	90 000
Disassembling tasks, including labour	200 000
Labour in the decontamination area, classification, cleaning, etc.	25 000
Cranes, trucks, heavy machinery	120 000
External waste management and disposal	42 000
Mercury recovery	23 000
Total	500 000
<i>Source: [275, ANE 2010]</i>	

Driving force for implementation

The driving forces for implementation of this technique include:

- business decision to close the mercury cell plant;
- environmental legislation.

Example plants

More than 50 mercury cell plants were decommissioned in the EU-27 and EFTA countries from 1980 to 2010. A list can be found in [94, Euro Chlor 2009]. Example plants include:

- Arkema in Saint Auban (France), former mercury cell chlorine capacity 184 kt/yr, decommissioned in 2006 [276, French Ministry 2010];
- Borregaard in Sarpsborg (Norway), decommissioned in 1997;
- Chimcomplex in Borzești (Romania), decommissioned in 1996 [57, CAK TWG 2012];
- Electroquímica de Hernani in Hernani (Spain), former mercury cell chlorine capacity 15 kt/yr, decommissioned in 2002 [275, ANE 2010];
- Ercros in Sabiñánigo (Spain), former mercury cell chlorine capacity 25 kt/yr, decommissioned in 2009 [275, ANE 2010].

Reference literature

[1, Ullmann's 2006], [57, CAK TWG 2012], [59, Euro Chlor 2010], [87, Euro Chlor 2006], [91, Euro Chlor 2011], [92, Gluszczyk et al. 2007], [94, Euro Chlor 2009], [166, CEN 2001], [167, CEN 2005], [168, ISO 2004], [175, CEN 2012], [177, CEN 2002], [178, CEN 2002], [184, Euro Chlor 2008], [222, Euro Chlor 2007], [227, de Flon 1998], [271, CEN 2006], [274, Ancery 2011], [275, ANE 2010], [276, French Ministry 2010]

4.1.3.2 Wastes consisting of elemental mercury or wastes contaminated with mercury

Large amounts of wastes consisting of elemental mercury or wastes contaminated with mercury are generated during decommissioning. Mercury is classified as very toxic [[76, Regulation EC/1272/2008 2008](#)] and waste containing very toxic substances at concentrations $\geq 0.1\%$ is classified as hazardous [[145, Decision 2000/532/EC 2000](#)]. General techniques for the treatment of these wastes are described in Section 4.1.3.1, in the Waste Treatments Industries BREF [[268, COM 2006](#)] and the technical guidelines of the Basel Convention [[310, Basel Convention 2011](#)].

Most of the mercury incurred during decommissioning is in its elemental form (Section 3.5.11.3). Metallic mercury no longer used in the chlor-alkali industry is considered as waste [[279, Regulation EC/1102/2008 2008](#)]. The storage of metallic mercury that is considered as waste for up to one year is subject to the permit requirements of the Waste Framework Directive [[269, Waste Framework Directive 98/EC 2008](#)]. If the storage time exceeds one year, the provisions of the Landfill Directive apply [[281, Directive 1999/31/EC 1999](#)]. In addition, the provisions of the Seveso II and Seveso III Directives apply if the quantities of stored mercury exceed the threshold values in Annex I to these Directives. The Seveso II Directive is repealed with effect from 1 June 2015 [[280, Seveso II Directive \(96/82/EC\) 1996](#)], [[338, Directive 2012/18/EU 2012](#)]. Additional requirements for the temporary storage for more than one year of metallic mercury considered as waste are addressed in Directive 2011/97/EU amending the Landfill Directive 1999/31/EC. The latter Directive does not include criteria for the permanent storage of metallic mercury because additional assessments were deemed necessary. Furthermore, this Directive takes note of the research activities on safe disposal options including solidification of metallic mercury but deems that it is premature to decide on the large scale viability of such an option [[282, Directive 2011/97/EU 2011](#)]. An overview of available options for the storage of metallic mercury with or without solidification can be found in [[283, BiPRO 2010](#)] and [[284, Krehenwinkel 2011](#)].

4.2 Diaphragm cell plants

4.2.1 Techniques to reduce emissions of asbestos and to reduce the generation of asbestos-containing waste

Given that the use of asbestos diaphragms is not BAT, techniques to reduce emissions of asbestos and to reduce the generation of asbestos-containing waste are not described in Chapter 4. This information can be found in Annex 8.3

4.2.2 Asbestos-free diaphragms

Description

This technique consists in using asbestos-free diaphragms which are based on fluoropolymer fibres and metal oxide fillers (e.g. zirconium dioxide). A conversion to asbestos-free diaphragms may require new equipment for the preparation of the diaphragms, for brine purification, and for the protection of the cathode against corrosion during shutdowns.

Technical description

Extensive worldwide research and development has been performed by industry to replace asbestos in diaphragms with other materials. Around 1970, polytetrafluoroethylene (PTFE), developed for astronautics, appeared on the market. With its superior characteristics regarding stability against chlorine, caustic soda and other chemicals, as well as its dimensional stability, it was considered an ideal alternative to asbestos. Asbestos swells during operation in a diaphragm cell and this increases the energy demand. PTFE does not show this swelling effect, and therefore the energy demand would be lower. In addition, the high stability against chlorine and caustic soda should result in the diaphragm having a very long lifetime. Due to these advantages, the hope was to develop a long-lasting non-asbestos diaphragm with a low energy demand. A lot of research effort was made for a couple of years but because of the inherent hydrophobic nature of PTFE it was only possible to replace up to around 20 % of asbestos fibres with this material, and with only small improvements in energy savings and extension of the diaphragm lifetime. This so-called polymer modified asbestos (PMA) diaphragm was still in use in 2011. Research was also carried out with some non-asbestos materials in combination with PTFE, but no successful asbestos replacement could be developed. For these reasons, research and development activities were rather limited for a certain time at the beginning of the 1980s [31, Euro Chlor 2010].

Laboratory tests using non-asbestos diaphragms began again in the mid-1980s, following increased pressure to reduce the use and emissions of asbestos due to serious health concerns. For the commercially available diaphragm cells, suitable alternatives have been developed on an industrial scale with the objective of bringing the new asbestos-free diaphragm technique to the same commercial level as the PMA diaphragms. Some requirements for the asbestos-free diaphragms are [31, Euro Chlor 2010]:

- adaptability to different cell designs;
- same deposition procedures (under vacuum) as those used for making asbestos diaphragms;
- suitable permeability (prevent reaction of chlorine with OH^- , isolate chlorine from hydrogen for safety reasons);
- same cell liquor strength and caustic quality as asbestos diaphragms;
- chemical stability (inert to oxidation by chlorine, hypochlorite and chlorate; inert under acidic and strong alkaline conditions);
- mechanical strength;
- provision of a high current efficiency under a wide range of current density/brine flow conditions.

Research on asbestos-free diaphragms has been carried out with the objectives of [31, Euro Chlor 2010]:

- achieving an extended service life (longer than asbestos diaphragms);
- reducing electricity consumption;
- meeting safety and environmental needs.

In 2011, two asbestos-free diaphragms were applied on an industrial scale, although only one was used in the EU-27. The differences between the diaphragms lie in the way the hydrophobic PTFE fibres are treated and deposited in order to form a permeable and hydrophilic diaphragm, as well as the mineral fillers used [31, Euro Chlor 2010].

De Nora Tech's Polyramix[®]/PMX[®] diaphragms are composed of (1) fibres with a PTFE polymer backbone with zirconia (ZrO₂) particles embedded in and on the PTFE, and (2) free zirconia particles. Together with the replacement of the existing diaphragm cell cathodes (or, as a minimum, the inner assembly portion of the cathode), the PMX[®] diaphragms can directly replace other diaphragms in Hooker H-type or Diamond MDC-type cells [212, Florkiewicz 1997], [213, Florkiewicz and Curlin 1992].

For the preparation of the diaphragms, a nylon mesh is put on the steel cathode, which is then immersed in the suspension containing the fibres. For several hours, a vacuum is sucked through the cathode and the fibres deposit on the nylon mesh (Figure 4.2). Subsequently, the cathode box is placed in an oven overnight at a temperature of ~ 350 °C, at which temperatures the PTFE fibres melt on the surface to stick together. The thickness of the diaphragms is ~ 0.5 cm. After cooling down, the anode is carefully placed over the cathode without damaging the diaphragm. With older anode designs, the distance between the anode and diaphragms amounted to a few millimetres. Newer anode designs rely on an expandable anode, which results in a final gap of approximately 1 mm, thereby reducing the electrical resistance of the cell and the consumption of electricity. Finally, the diaphragm needs to be wetted out for approximately one day prior to being put into operation. At the end of their lifetime, the diaphragms are mechanically removed from the steel cathodes under dry conditions [118, Solvay 2011].



Figure 4.2: View of the deposition of an asbestos-free diaphragm on a cathode

PPG's Tephram[®] diaphragms are composed of three components: basecoat, topcoat, and dopant. The basecoat, containing PTFE fibres, PTFE microfibres, a perfluorinated ion-exchange resin

and other constituents, is vacuum deposited on the cathode screen. The PTFE fibres form the base mat and the microfibrils provide a suitable porosity. The ion-exchange resin contributes to the wettability of the PTFE mat. The topcoat, with inorganic particles (metal oxides such as zirconium oxide or titanium dioxide), is applied on the basecoat by vacuum deposition to achieve adequate permeability and uniformity. The third component, which contains soluble and insoluble materials such as magnesium hydroxide and magnesium aluminosilicates, is added to the anolyte during start-up and also intermittently during operation, to form a gel layer in the micropores of the diaphragm mat to improve the performance of the diaphragm. The final diaphragm is typically about 2.5 mm thick. Tephram[®] diaphragms have been used in Diamond MDC-type, Columbia N-type and Glanor cells [216, O'Brien et al. 2005, Section 4.7.6], [218, Ahmed and Foller 2003]

Achieved environmental benefits

The achieved environmental benefits of this technique include:

- prevention of asbestos emissions;
- prevention of the generation of asbestos-containing waste;
- reduction of energy consumption.

Environmental performance and operational data

PMX[®] fibres have a diameter of 10–100 µm and are 1 000–7 000 µm long, which renders them non-carcinogenic. Chrysotile asbestos fibres, for comparison, have a diameter of 0.1–0.3 µm and are 0.1–6.0 µm long [216, O'Brien et al. 2005, Section 4.7.6].

Non-asbestos diaphragms have demonstrated a number of advantages over asbestos diaphragms in chlor-alkali cell operation with high current density. A lifetime of at least five years can be considered average for an industrial cell room [31, Euro Chlor 2010], while the lifetime of polymer modified asbestos diaphragms in commercial diaphragm cells ranges from 200 to 500 days [1, Ullmann's 2006], [10, Kirk-Othmer 2002]. For example, the OxyChem plant (formerly Vulcan Chemicals) in Geismar/Louisiana (United States), fully converted since 1993, and the two Kem One (formerly Arkema) plants in Fos-sur-mer and Lavéra (France), fully converted since 2002, are achieving average diaphragm lives of greater than 3 000 days, while operating at an average current density of 2.55–2.65 kA/m². Demonstration blocks of 10 to 20 PMX[®] diaphragm cells in Europe have lasted over 10 years and the oldest PMX[®] diaphragm cell at an Arkema plant operated for more than 13 years before it was replaced on the occasion of a cathode leakage [31, Euro Chlor 2010].

In the case of non-asbestos diaphragms, the separator is therefore no longer the most short-lived component of the diaphragm cell. As the non-asbestos diaphragm is expected to last several years, the main cause of failure of the diaphragm cell is the gaskets (base covers and perimeter gaskets). These gaskets now pose the biggest challenge to overcome if a three to five year cell life is to be achieved [212, Florkiewicz 1997]. For this purpose, a company has developed a specific technique to change these gaskets without damaging the diaphragm and to restart the cell with the same separator [31, Euro Chlor 2010].

In addition to the long lifetimes, asbestos-free diaphragms show extreme stability with respect to load variations and outages. PMX[®] diaphragm cells operated with pure brine do not show any increase in energy consumption after a few years, even after repeated shutdowns. The operation of non-asbestos diaphragms may actually result in net energy savings. They can be used with a zero-gap cell design by using expandable anodes [31, Euro Chlor 2010]. In the case of asbestos diaphragms, the use of expandable anodes is hampered by the swelling of the diaphragm during operation, which leads to a pH increase at the anode, resulting in increased oxygen production and reduced current efficiency [313, Euro Chlor and Dow 2012]. The specific electrical energy consumption of cells with non-asbestos diaphragms is approximately 100–150 kWh/t Cl₂ produced lower than that of cells with asbestos diaphragms at the same current density (Section 3.3.4.3.3) [63, Euro Chlor 2011]. Approximately one third of this reduced energy consumption is due to the diaphragm itself, another third to a zero-gap configuration and

expandable anodes and another third to improved cathodes [300, Euro Chlor 2011]. For example, the conversion to asbestos-free diaphragms at Arkema also involved the replacement of anodes and cathodes by expandable anodes and better performing cathodes, resulting in an overall reduction of electricity consumption for the electrolysis of 3–4 % [31, Euro Chlor 2010].

Asbestos-free diaphragm cells may also be operated with higher cell liquor strength, leading to reduced steam consumption to concentrate the caustic. Furthermore, the brine can be acidified to reduce the oxygen content in the produced chlorine [31, Euro Chlor 2010].

Cross-media effects

Some raw materials and energy are consumed for the production of the diaphragms.

Polyramix[®] diaphragms require the use of biocides in the suspension to avoid fermentation of the biogum used to suspend the dense fibres in the depositing slurry bath. The waste water is fairly alkaline and contains organics from the suspension thickener. The effluent system therefore needs to be able to handle this organic load.

The Tephram[®] diaphragms require 'doping' with ancillary materials such as magnesium hydroxide and magnesium aluminosilicates during operation to maintain the required wettability and permeability.

Technical considerations relevant to applicability

Asbestos-free diaphragms can be applied in new and existing diaphragm cell plants. In some cases, the conversion to asbestos-free diaphragms requires new diaphragm preparation equipment, while in others the former asbestos equipment can be reused [31, Euro Chlor 2010].

Commercially available diaphragm cells can be operated in the current density range of 1.2–2.8 kA/m², depending on the cell type [1, Ullmann's 2006]. The lower limit of the current density is given by the minimum brine flowrate that allows a sufficient hydrostatic head of the anolyte versus the catholyte to be maintained in order to prevent the diffusion of hydrogen from the cathode compartment through the diaphragm into chlorine. If the current intensity is further reduced, the brine flowrate has to be maintained, thereby resulting in lower caustic concentrations in the cell liquor (down to ~ 7 wt-%). A possible way to address this issue is to adjust the porosity of the diaphragm [313, Euro Chlor and Dow 2012].

Dow is using its own, proprietary bipolar asbestos diaphragm cell design, which is optimised for low current densities of 0.55–0.7 kA/m² and which uses large active areas (~ 100 m² for a single bipolar element). The electrolyzers are operated at ~ 80 °C, which is lower than the more typical operating temperature of 95 °C for other cell types. Advantages of this design include simplicity, ruggedness, low electricity consumption and long lifetimes of the PMA diaphragms. However, investment costs are high due to the low chlorine production rate per surface area. In 2011, Dow reported that, despite a long history of research and development activities including several large production runs, no suitable alternative diaphragms had been found. Asbestos-free diaphragms available on the market were developed for the more usual higher current densities and are, according to Dow, not suitable for their bipolar cells. One of the limiting factors is the large diaphragm area which sets tighter requirements on diaphragm homogeneity, both for a single diaphragm and within a series [1, Ullmann's 2006], [31, Euro Chlor 2010], [111, Dow 2012], [215, German Ministry 2011].

Particular attention must be paid to the brine system, since poor brine will cause a non-asbestos diaphragm to plug at least as quickly as an asbestos diaphragm. In addition, the cathode must be protected from corrosion during shutdowns [31, Euro Chlor 2010]. Whenever the current is interrupted, a reverse current flows through the cell because of the presence of active chlorine species in the anolyte. As a result, the cathode becomes anodic for a brief period until all the active chlorine species are reduced to chloride. Also, following a shutdown, the hypochlorite in

the anolyte is transported through the diaphragm into the catholyte, raising its hypochlorite level to 0.3–5 g/l. As a result, corrosion of the steel cathode takes place and iron oxides plug the diaphragm. This results in tighter diaphragms, higher caustic strength, and lower efficiency. When the cell is put back into operation, the iron oxides are reduced to iron and become points for the evolution of hydrogen, leading to increased hydrogen levels in chlorine [216, O'Brien et al. 2005, Section 4.6.6]. Techniques to refresh plugged diaphragms and to remove iron are available (e.g. by washing with hydrochloric acid) [216, O'Brien et al. 2005, Section 4.7.6]. However, the preferred method of operation is to avoid these problems by using pure and in particular filtered brine, especially if vacuum salt from a caustic evaporator is used. Techniques to protect the cathode during shutdown include the injection of reducing agents and a polarisation rectifier [31, Euro Chlor 2010].

General Electric in Mount Vernon (United States), was fully converted to PMX[®] diaphragms at one time but problems with iron in the brine forced General Electric to switch back to PMA diaphragms. The brine contained high levels of iron and gluconate originating from the recycling of waste water from a polycarbonate production unit. The impurities plugged the diaphragms within 9–15 months, while the gluconate prevented any acid washing. The asbestos-free diaphragms were therefore not economical [221, Florkiewicz 1998].

Problems with iron impurities were also reported by the Zachem plant in Bydgoszcz (Poland) during test runs with asbestos-free diaphragms in 1999/2000. The plant recycled salt-containing waste water from other production units back into the brine system (Section 4.3.2.1.3). Zachem reported that the use of asbestos-free diaphragms would therefore require major changes to the brine treatment system [220, Polish Ministry 2011].

Economics

Economic benefits of using non-asbestos diaphragms come from [31, Euro Chlor 2010]:

- reduced operating costs due to lower cell voltage;
- reduced cell renewal costs due to longer lifetimes of the diaphragms and steel cathodes (fewer shutdowns lead to less corrosion); reduced waste handling and disposal costs due to asbestos-free materials.

Despite the higher purchase costs (up to 20 times the costs of a PMA diaphragm), the economic viability of using asbestos-free diaphragms has been proven industrially in several plants [31, Euro Chlor 2010]. In the case of the Dow plant in Stade, the economics of conversion to asbestos-free diaphragms are less favourable. Operating a plant at low current densities (0.55–0.7 kA/m²) implies higher material costs due to larger electrode areas compared to a plant operating at high current densities with the same production rate. In addition, the achieved asbestos diaphragm lifetimes of 5–10 years at these operating conditions are in the same order of magnitude as those of asbestos-free diaphragms [318, Dow 2012].

On-site capital requirements for a conversion remain highly site-specific and the configuration of the cells (cells with large active area, linked to the chlorine production per m² of diaphragm) may greatly influence the cost of a conversion. The additional equipment required for conversion may include a diaphragm preparation facility, a reducing agent injection system, and a polarisation rectifier to protect the cathodes against corrosion, as well as additional brine purification equipment [31, Euro Chlor 2010]. The total cost (everything included) for converting a diaphragm cell plant with a chlorine capacity of 160 kt/yr to PMX[®] diaphragms was reported to be EUR 1.4–2 million in 1999 [75, COM 2001].

Driving force for implementation

The driving forces for implementation of this technique include:

- environmental, as well as occupational health and safety legislation;
- reduction of costs related to energy consumption;
- reduction of costs related to cell maintenance.

Example plants

Approximately ten plants worldwide use asbestos-free diaphragms [215, German Ministry 2011]. Example plants include:

- Kem One (formerly Arkema) in Fos-sur-mer (France), chlorine capacity of diaphragm cell unit 150 kt/yr, cells: MDC-55, conversion to PMX[®] diaphragms in 2000 to 2002 [31, Euro Chlor 2010];
- Kem One (formerly Arkema) in Lavéra (France), chlorine capacity of diaphragm cell unit 175 kt/yr, cells: HC-4B, conversion to PMX[®] diaphragms in 2000 to 2002 [31, Euro Chlor 2010];
- Carbochloro in Cubatão/São Paulo (Brazil), chlorine capacity of diaphragm cell unit 140 kt/yr, cells: MDC-55, conversion announced for 2008 to 2009 [31, Euro Chlor 2010], [219, Carbochloro 2008];
- Hüls in Rheinfelden (Germany), full conversion to PMX[®] diaphragms in 1991, plant was shut down 1993 [221, Florkiewicz 1998];
- Mexichem in Coatzacoalcos/Vera Cruz (Mexico); chlorine capacity of diaphragm cell unit 264 kt/yr, cells: Glanor [31, Euro Chlor 2010];
- OxyChem (formerly Vulcan Chemicals) in Geismar/Louisiana (United States), chlorine capacity of diaphragm cell unit 273 kt/yr, cells: MDC-55; full conversion to PMX[®] diaphragms since 1993;
- Vencorex (formerly Perstorp) in Le Pont de Claix (France), chlorine capacity 170 kt/yr (only diaphragm cells), cells: H-4, HC-3B, conversion to PMX[®] diaphragms in 1999 to 2003 [31, Euro Chlor 2010];
- PPG in Lake Charles, Louisiana (United States), chlorine capacity of diaphragm cell unit ~ 1 100 kt/yr, cells: Glanor V-1161 and V-1244; full conversion of V-1244 cells (chlorine capacity ~ 680 kt/yr) to Tephram[®] diaphragms since 2003; full plant conversion to Tephram[®] diaphragms finalised in 2010 [217, PPG 2010], [218, Ahmed and Foller 2003];
- PPG in Natrium, West Virginia (United States), chlorine capacity of diaphragm cell unit 297 kt/yr, cells: MDC-55, N-3 and N-6; full conversion of N-6 cells (chlorine capacity 58 kt/yr) to Tephram[®] diaphragms since 1992; full plant conversion to Tephram[®] diaphragms nearly completed in 2010 [214, Dilmore and DuBois 1995], [217, PPG 2010], [218, Ahmed and Foller 2003];
- Sasol in Sasolburg (South Africa), chlorine capacity of diaphragm cell unit 92 kt/yr, cells: MDC-55 [31, Euro Chlor 2010];
- Solvay in Rheinberg (Germany), chlorine capacity of diaphragm cell unit 110 kt/yr, cells: DAT/DBT-43, conversion to PMX[®] diaphragms in 2011 to 2012 [118, Solvay 2011].

Reference literature

[1, Ullmann's 2006], [10, Kirk-Othmer 2002], [31, Euro Chlor 2010], [63, Euro Chlor 2011], [75, COM 2001], [111, Dow 2012], [118, Solvay 2011], [146, Arkema 2009], [212, Florkiewicz 1997], [213, Florkiewicz and Curlin 1992], [214, Dilmore and DuBois 1995], [215, German Ministry 2011], [216, O'Brien et al. 2005], [217, PPG 2010], [218, Ahmed and Foller 2003], [219, Carbochloro 2008], [220, Polish Ministry 2011], [221, Florkiewicz 1998], [300, Euro Chlor 2011], [313, Euro Chlor and Dow 2012], [318, Dow 2012]

4.2.3 Conversion of asbestos diaphragm cell plants to membrane cell plants

Description

This technique consists in converting asbestos diaphragm cell plants to membrane cell plants. A conversion to the membrane cell technique includes a change of electrolyzers, additional brine purification, additional brine dechlorination, inclusion of a cell room caustic soda recirculation

system, as well as a change of transformers and rectifiers. The caustic concentration unit usually also requires some adaptations.

Technical description

The important changes to an existing plant when converting from diaphragm cells to membrane cells are included in the following list [31, Euro Chlor 2010], [211, Dibble and White 1988]:

- change of electrolyzers;
- additional brine purification, including hardness removal ion-exchange techniques. A polishing filtration step is usually also necessary before the ion exchange. Modifications to brine treatment to control other impurities, such as sulphate, may also be required;
- additional brine dechlorination to protect the ion-exchange resin. It is necessary to complete the brine recirculation loop by adding primary and secondary dechlorination and possibly resaturation;
- inclusion of a cell room caustic soda recirculation system. If 50 wt-% product is required, the existing diaphragm cell caustic soda evaporator must be modified and simplified to accept high-strength, salt-free caustic soda;
- change of transformers, rectifiers, and other minor equipment of the cell room system.

At the BASF plant in Ludwigshafen (Germany), the conversion involved the following changes [31, Euro Chlor 2010]:

- addition of supplementary brine filtration unit and ion exchangers to remove calcium and magnesium (the sulphate and silica levels were controlled via purge);
- addition of a two-step brine dechlorination unit based on vacuum dechlorination and chemical dechlorination with sodium hydrogen sulphite;
- addition of some piping to close the brine loop;
- dismantling of all diaphragm cells and installation of new electrolyzers in the same cell room where the anolyte and catholyte tanks were installed;
- addition of a caustic loop;
- conversion of the old diaphragm cell liquor evaporation unit to produce vacuum salt;
- addition of a caustic evaporation unit.

At the Anwil plant in Włocławek (Poland), the conversion comprised the following changes [31, Euro Chlor 2010]:

- addition of a new brine purification unit;
- addition of a new brine dechlorination unit;
- addition of a new caustic soda evaporator;
- modification of the existing cell liquor evaporation unit to concentrate the diluted brine;
- replacement of the diaphragm electrolyzers by bipolar membrane electrolyzers.

Achieved environmental benefits

The achieved environmental benefits of this technique include:

- prevention of asbestos emissions;
- prevention of the generation of asbestos-containing waste;
- reduction of energy consumption.

Environmental performance and operational data

A technical advantage of the conversion is that membrane cells generally exhibit an increased tolerance to power fluctuations, which is especially attractive in regions with fluctuating energy prices [31, Euro Chlor 2010].

At the Anwil plant in Włocławek (Poland), the conversion led to a 50 % reduction in steam consumption and a 5 % reduction in electricity consumption, as well as the prevention of

asbestos emissions and asbestos waste generation. Furthermore, the plant eliminated the need to use liquid ammonia to purify the caustic soda [31, Euro Chlor 2010].

At the INEOS ChlorVinyls plant (formerly Norsk Hydro) in Rafnes (Norway), the conversion led to a reduction in electricity consumption of almost 15 % and in steam consumption of approximately 65 % [307, Hydro Polymers 2007].

Cross-media effects

Significant amounts of raw materials and energy are required for the installation of the new equipment.

Technical considerations relevant to applicability

Generally, there are no technical restrictions to the applicability of this technique.

Economics

The conversion of a diaphragm cell plant to a membrane cell plant can be an attractive choice because of the high energy efficiency and the pure 33 wt-% caustic produced directly from the cells. This is especially the case when there is a need for high-purity 50 wt-% caustic, due to the reduced costs of evaporation and the higher caustic quality of the membrane cell technique and/or when the diaphragm cell plant is operated at current densities $> 1.5 \text{ kA/m}^2$. At low current densities, the specific electricity consumption of a diaphragm cell plant can be lower than that of a membrane cell plant (Sections 3.3.4.3 and 4.3.2.3.1) [31, Euro Chlor 2010].

In comparison to the use of asbestos-free diaphragms (Section 4.2.2), the conversion to the membrane cell technique requires a large capital investment of at least EUR 300–400/t annual chlorine capacity. For example, the total investment cost for the conversion at the Anwil plant in Włocławek (Poland) was approximately PLN 230 million in 2004 to 2005 (equivalent to approximately EUR 60 million). The operating costs of the two options depend on steam and electricity costs, labour costs, and the required caustic quality [31, Euro Chlor 2010].

The final choice of a plant operator between asbestos-free diaphragms and the membrane cell technique will therefore depend on the situation at the individual site.

Driving force for implementation

The driving forces for implementation of this technique include:

- environmental, as well as occupational health and safety legislation;
- reduction of costs related to energy consumption;
- improved quality of produced caustic.

Example plants

- AkzoNobel in Bitterfeld (Germany), chlorine capacity 99 kt/yr (only membrane cells), shutdown of diaphragm cell plant in 1997, construction of membrane cell plant in 1998 to 2000;
- Anwil in Włocławek (Poland), chlorine capacity 214 kt/yr (only membrane cells), conversion in 2004/2005;
- BASF in Ludwigshafen (Germany), chlorine capacity of membrane cell unit 215 kt/yr, conversion in 2003;
- INEOS ChlorVinyls (formerly Norsk Hydro) in Rafnes (Norway), chlorine capacity 260 kt/yr (only membrane cells), conversion in 2005.

Reference literature

[31, Euro Chlor 2010], [211, Dibble and White 1988], [307, Hydro Polymers 2007]

4.3 Diaphragm and membrane cell plants

4.3.1 Environmental management systems

Environmental management systems (EMS) are of general relevance for the chemical industry and are not specific to the chlor-alkali industry. EMS are therefore described in the reference document on Common Waste Water and Waste Gas Treatment/Management Systems in the Chemical Sector (CWW BREF) [[124, EC 2003](#)].

Chlor-alkali plants are usually integrated in a larger chemical industrial park, which will often comprise several companies. An EMS therefore encompasses all production units of a specific company at a given site or may even cover a whole multi-operator site. An EMS may be part of a convention which is a contractual document dealing (or not) with environment, health and safety risks and which is established between two or more companies operating on the same site [[123, Gaucher et al. 2008](#)], [[124, EC 2003](#)].

In 2012, out of the total of 75 chlor-alkali manufacturing sites in the EU-27 and EFTA countries, 16 were accredited according to EMAS and 59 according to ISO 14001 [[9, Euro Chlor 2013](#)]. Euro Chlor previously set the target that by 2010 all of its full member companies (66 sites) should be accredited to at least ISO 14001 [[73, Debelle 2011](#)].

4.3.2 Techniques to reduce the consumption of raw materials

4.3.2.1 Salt

4.3.2.1.1 Choice of salt type

The different types of salt used in chlor-alkali plants (Section 2.5.1) all show advantages and disadvantages in terms of their overall environmental impact. An overview of applied processes and techniques for the production of sodium and potassium chloride can be found in [[66, Ullmann's 2010](#)] and [[12, Ullmann's 2000](#)], respectively.

All types of salt require energy for their extraction, purification and transport, which depends on the extraction techniques used, as well as on the means of transport and the distance from the salt source to the chlor-alkali plant.

Vacuum salt is the purest salt used in chlor-alkali plants, and is favourable in terms of the **plant** consumption of ancillary materials, the generation of brine filtration sludges, process stability and energy consumption. However, the production of vacuum salt requires considerable amounts of energy (Section 3.3.4.2), ancillary materials for chemical purification are needed, and wastes are generated **off site** [[66, Ullmann's 2010](#)]. Rock salt, salt from potash mining wastes and solution-mined brine are less pure than vacuum salt and thus require higher amounts of ancillary materials for brine purification and lead to higher amounts of brine filtration sludges (Table 3.22). When salt from potash mining wastes is used, no additional energy for mining is required and raw materials are saved. Moreover, its consumption contributes to the restoration of the original landscape [[27, ANE 2010](#)]. Solar salt uses the renewable energy from the sun for the evaporative step but additional purification is usually required.

Several of the factors concerning the overall environmental impact of the different types of salt are outside the scope of this document and depend on local conditions, such as the means of transport and the distance from the salt production to the chlor-alkali plant. Therefore, no proposals are made with respect to the use of a specific type of salt as a technique to consider in the determination of BAT.

4.3.2.1.2 Techniques to reduce the consumption of salt

In addition to the techniques described in the following Section 4.3.2.1.3, several of the techniques to reduce consumption of water (Section 4.3.2.2), to reduce emissions of chloride (Section 4.3.6.2) and to reduce emissions of chlorate (Section 4.3.6.4) also reduce salt consumption.

4.3.2.1.3 Recycling of waste water from other production processes

Description

This technique consists in recycling salt-containing effluents from other production processes to the brine system of the chlor-alkali plant.

Technical description

The treatment required for waste water recycling is plant-specific and depends on the impurities contained in the waste water.

At the AkzoNobel plant in Bitterfeld (Germany), a part of the chlorine is burnt with hydrogen to produce gaseous HCl, which is subsequently used to produce silicon tetrachloride, which is in turn used for the production of ultra pure quartz glass. The resulting hydrogen chloride from the last production step is absorbed in caustic soda, resulting in a saturated NaCl solution with different kinds of impurities (mainly based on silicon compounds). This brine is then treated to remove the impurities and recycled as feed to the electrolysis process [315, Euro Chlor 2011].

At the SABIC plant in Bergen op Zoom (Netherlands), waste water from the polycarbonate production unit undergoes a series of purification steps before it is recycled to the brine circuit [128, SABIC 2008]:

- isolation of brine from the reaction product using special decanters at the resin plant;
- removal of solvent via distillation at the resin plant (modified equipment);
- removal of suspended solids via filtration at the central waste water treatment plant (modified equipment);
- adsorption of phenolic compounds via active carbon beds at the central waste water treatment plant (modified equipment);
- destruction of carbonates via acidification (newly designed unit for this purpose);
- adsorption of nitrogen-containing components via special active carbon beds (newly designed unit for this purpose);
- adsorption of metal ions on ion adsorption resins in the chlor-alkali plant (modified equipment);
- removal of conductive components via special adsorption beds in the chlor-alkali plant (modified equipment).

Achieved environmental benefits

The achieved environmental benefits of this technique include:

- reduction of salt consumption;
- reduction of water consumption;
- reduction of chloride emissions.

Environmental performance and operational data

At the AkzoNobel plant in Bitterfeld (Germany), approximately 8–10 % of the consumed brine is obtained by neutralising a gaseous hydrogen chloride stream with sodium hydroxide [315, Euro Chlor 2011].

At the Arkema plant in Saint Auban (France), waste water generated during a chlorination process and containing hydrochloric acid is neutralised with caustic soda and fed back to the

electrolysis unit after being stripped of organic contaminants. If the waste water contains excess amounts of caustic soda, it is neutralised with hydrogen chloride [3, Euro Chlor 2011], [33, Euro Chlor 2011].

At the Dow plant in Stade (Germany), waste water generated during the production of propylene oxide is sent back for solution mining after biological and physico-chemical treatment. This results in savings of approximately 10 000 000 m³/yr of fresh water and the same volume of waste water not discharged [33, Euro Chlor 2011]. Previously, a total water consumption of 30 000 000 m³/yr was reported. Waste water recycling resulted in conservation of 7 000 000 m³/yr of river water and 600 000 t/yr of salt, as well as a 23 % reduction of annual salt discharge [129, Euro Chlor 2007].

At the SABIC plant in Bergen op Zoom (Netherlands), 73 % of the NaCl leaving the polycarbonate production unit is recycled, which is equivalent to vacuum salt savings and related emissions of approximately 72 000 t/yr. Moreover, water consumption is reduced by 225 000 m³/yr [128, SABIC 2008].

At the Zachem plant in Bydgoszcz (Poland), hydrochloric acid obtained during the production of epichlorohydrin and toluene di-isocyanate is neutralised with the caustic liquor from the diaphragm cells and recycled [220, Polish Ministry 2011].

Cross-media effects

Some raw materials and energy are consumed for the installation and operation of the additional waste water treatment units.

Technical considerations relevant to applicability

The recycling of salt-containing waste water is restricted by two major factors. First, it is necessary to ensure that no contaminants with a detrimental effect on the electrolysis process are introduced into the brine system. This includes heavy metals, which negatively affect the lifetime of the diaphragm or membrane, as well as the energy consumption, in particular for the membrane cell technique (Table 2.4). High residual concentrations of organic compounds are also unwanted in the membrane cell technique (Table 2.4) and may lead to the formation of halogenated organic compounds (Section 3.4.3.3.8). Second, the water balance of the electrolysis unit has to be respected [33, Euro Chlor 2011].

Economics

At the SABIC plant in Bergen op Zoom, investment costs for the waste water recycling system amounted to EUR 11 million. Annual cost savings due to the reduced consumption of salt and demineralised water are equal to EUR 3.8 million. This results in a payback time on investment costs of two and a half to three years [128, SABIC 2008].

Driving force for implementation

The driving force for implementation of this technique is a reduction of operating costs due to the reduced consumption of salt and water.

Example plants

- AkzoNobel in Bitterfeld (Germany), chlorine capacity 99 kt/yr;
- Arkema in Saint Auban (France), chlorine capacity 20 kt/yr;
- Dow in Stade (Germany), chlorine capacity 1 585 kt/yr;
- SABIC in Bergen op Zoom (Netherlands), chlorine capacity 89 kt/yr;
- Zachem in Bydgoszcz (Poland), chlorine capacity 72 kt/yr, plant was shut down in 2012.

Reference literature

[3, Euro Chlor 2011], [33, Euro Chlor 2011], [128, SABIC 2008], [129, Euro Chlor 2007], [220, Polish Ministry 2011], [315, Euro Chlor 2011]

4.3.2.2 Water

4.3.2.2.1 Overview

Water which is consumed in the production of chlor-alkali leaves the process either via the products (hydrogen and caustic solution) or as waste water (Section 3.3.2).

With regards to the generation of waste water, various techniques can be used to reduce water consumption and are described in the following sections. A general overview can be found in the CWW BREF [124, EC 2003] and in [132, Germany 2000].

4.3.2.2.2 Brine recirculation

Description

This technique consists in resaturating the depleted brine from the electrolysis cells with solid salt or by evaporation. The saturated brine is fed back to the cells.

Technical description

A detailed description of the brine recirculation system is given in Section 2.5.

Achieved environmental benefits

The achieved environmental benefits of this technique include:

- reduction of water consumption;
- reduction of salt consumption;
- reduction of chloride emissions.

Environmental performance and operational data

Almost all membrane cell plants in the EU-27 and EFTA countries use a brine recirculation system. The average volume of waste water discharged is approximately 2 tonnes per tonne of chlorine produced [73, Debelle 2011]. For comparison, 9–11 tonnes of water per tonne of chlorine produced are discharged as waste water when using a once-through brine process (Section 4.3.2.3.6).

Cross-media effects

Plants which use solution-mined brine need to evaporate water from the depleted brine for its recirculation. This requires significant additional energy (Section 4.3.2.3.6). Alternatively, the depleted brine can be reused for solution mining (Section 4.3.2.2.5).

Technical considerations relevant to applicability

Due to their inherent design, diaphragm cell plants do not use brine recirculation.

If the depleted brine of membrane cell plants is not resaturated and recirculated but instead is used in other production units, the overall water consumption of the site is not reduced (Section 4.3.2.2.6).

Economics

The reduction of operating costs due to the reduced consumption of salt and water renders brine recirculation economically favourable in most cases.

Driving force for implementation

The driving forces for implementation of this technique include:

- reduction of operating costs due to the reduced consumption of water and salt;
- limited availability of water resources;
- environmental legislation.

Example plants

Almost all membrane cell plants in the EU-27 and EFTA countries use a brine recirculation system.

Reference literature

[1, Ullmann's 2006], [10, Kirk-Othmer 2002], [17, Dutch Ministry 1998], [37, Euro Chlor 2010], [73, Debelle 2011]

4.3.2.2.3 Recycling of other process streams**Description**

This technique consists in feeding back process streams from the chlor-alkali plant to various steps of the process. Process streams which are usually recycled include the condensates from chlorine, caustic and hydrogen processing.

Technical description

A number of process streams originating in the chlor-alkali plant can be recycled [33, Euro Chlor 2011], [121, MicroBio 2012]:

- The condensates from chlorine processing are usually recycled in the brine.
- The condensates from hydrogen processing can be used to produce caustic or are recycled to the brine saturator.
- The condensates from caustic evaporation are usually recycled in the catholyte circuit of the membrane electrolysis unit, in the brine loop or used to dilute caustic if necessary.
- Diluted sulphuric acid from the chlorine drying unit can often be used (at least partially) to adjust the pH of the liquid effluents to be discharged. Alternatively, the acid may be reconcentrated and reused.
- The off-specifications caustic can be used for other purposes, such as pH adjustment or to feed the caustic production circuit.
- The chlorinated caustic effluent from the chlorine absorption unit can be recycled in the brine or for the production of saleable hypochlorite.
- The brine purge can be used to regenerate the ion-exchange resins from secondary brine purification, provided that the impurities contained in the brine, such as chlorate, do not damage the resins.
- Rinse water from the regeneration of the ion-exchange resins from secondary brine purification can be recycled to the brine saturator.

Achieved environmental benefits

The achieved environmental benefits of this technique include:

- reduction of water consumption;
- reduction of salt consumption (for some of the streams);
- reduction of chloride and sulphate emissions (for some of the streams).

Environmental performance and operational data

From chlorine processing, 200 kg of condensed water per tonne of chlorine cooled from 85 °C to 25 °C are typically recycled. From hydrogen processing, 50–100 kg of condensed water per tonne of chlorine produced are typically recycled, depending on the cooling intensity [3, Euro Chlor 2011].

Cross-media effects

Additional consumption of energy and raw materials result if process streams require treatment prior to their recycling. This might offset the environmental benefits, depending on the local conditions.

Technical considerations relevant to applicability

The recycling of process streams is limited by two factors, the purity requirements of the liquid stream to which the process stream is recycled and the water balance of the brine circuit (Section 4.3.2.1.3).

Economics

The reduction of operating costs due to the reduced consumption of salt and water renders the recycling of process streams economically favourable in most cases.

Driving force for implementation

The driving forces for implementation of this technique include:

- reduction of operating costs due to the reduced consumption of water and salt;
- limited availability of water resources;
- environmental legislation.

Example plants

Process streams are recycled to varying degrees in all chlor-alkali plants in the EU-27 and EFTA countries.

Reference literature

[33, Euro Chlor 2011], [121, MicroBio 2012]

4.3.2.2.4 Concentration of brine filtration sludges

Description

This technique consists in concentrating brine filtration sludges in filter presses, rotary drum vacuum filters or centrifuges. The residual water is fed back into the brine system.

Technical description

This technique avoids flushing the sludge with a weak hydrochloric acid solution to the waste water treatment unit, thereby reducing the consumption of water and acid and emissions of chloride (Sections 2.5.3.1 and 3.4.3.4).

Achieved environmental benefits

The achieved environmental benefits of this technique include:

- reduction of water consumption;
- reduction of acid consumption;
- reduction of chloride emissions.

Environmental performance and operational data

No information provided.

Cross-media effects

Some raw material and energy is used for the installation and operation of the sludge-concentration equipment.

Technical considerations relevant to applicability

Generally, there are no technical restrictions to the applicability of this technique.

In some cases, the filter cake from brine filtration is dry enough that no further concentration is required.

In the case of plants reusing waste water for solution mining (Section 4.3.2.2.5), the concentration of brine filtration sludges does not lead to reduced water consumption.

Economics

No information provided.

Driving force for implementation

The driving forces for implementation of this technique include:

- reduction of operating costs due to the reduced consumption of water and acid;
- environmental legislation.

Example plants

Concentration of brine filtration sludges is generally used by chlor-alkali plants [3, Euro Chlor 2011].

Reference literature

[3, Euro Chlor 2011]

4.3.2.2.5 Use of waste water for solution mining**Description**

This technique consists in treating waste water from the chlor-alkali plant and pumping it back to the salt mine for its reuse in solution mining.

Technical description

At the Dow plant in Stade (Germany), the treatment of waste water from the chlor-alkali plant generally involves stripping and chemical reduction with hydrogen sulphite. Some of the waste water streams are also directed to a calcium precipitation unit. Subsequently, the waste water is reused for solution mining [111, Dow 2012].

Achieved environmental benefits

The achieved environmental benefits of this technique include:

- reduction of water consumption;
- reduction of salt consumption;
- reduction of chloride emissions.

Environmental performance and operational data

At the Dow plant in Stade (Germany), all waste water generated in the chlor-alkali plant is treated and sent back for solution mining. No waste water is generated [57, CAK TWG 2012], [111, Dow 2012].

Cross-media effects

Some raw material and energy are used for the treatment of the waste water prior to recycling. Additional pipelines and energy are required to pump the waste water back to the mine. The additional consumption of energy is substantial if the mine is located at a significantly higher altitude than the plant.

This technique may lead to a poorer brine quality and therefore to a cell operation under non-optimum conditions (increased electricity consumption) [111, Dow 2012].

Technical considerations relevant to applicability

This technique is restricted to sites which use solution-mined brine as a raw material. Instead of its reuse for solution mining, some plants use their waste water in other production units (Section 4.3.2.2.6).

Economics

No information provided.

Driving force for implementation

The driving forces for implementation of this technique include:

- reduction of operating costs due to the reduced consumption of water and salt;
- environmental legislation.

Example plants

- Dow in Stade (Germany), chlorine capacity 1 585 kt/yr;
- Olchim in Râmnicu Vâlcea (Romania), chlorine capacity of membrane cell unit 105 kt/yr.

Reference literature

[57, CAK TWG 2012], [111, Dow 2012]

4.3.2.2.6 Use of waste water in other production units

The generation of waste water can be reduced by recycling process streams from the chlor-alkali plant to other production units. Examples of this technique are the recycling of waste water streams containing free chlorine (Section 4.3.6.3.7) and chlorate (Section 4.3.6.4.5).

4.3.2.2.7 Miscellaneous techniques

Other techniques to reduce water consumption include [124, EC 2003], [130, Austria 1996], [131, Germany 2003], [132, Germany 2000]:

- waste water-free processes for vacuum generation;
- waste water-free processes for exhaust air cleaning;
- reduction of brine purge volume by using vacuum salt;
- reduction of brine purge volume by using nanofiltration (Section 4.3.6.2.2);
- reduction of brine purge volume by using techniques to reduce chlorate emissions (Section 4.3.6.4).

Although residual levels of chlorine in process exhaust are removed by wet scrubbing with caustic, waste water is not necessarily generated because the produced bleach is sometimes used to feed the unit producing saleable hypochlorite or because it can be recycled to the brine system (Section 4.3.6.3.6).

The brine purge volume can be reduced by using vacuum salt, the production of which, however, requires significant amounts of energy for purification (Section 4.3.2.1.1).

4.3.2.2.8 Combination of techniques to reduce the generation of waste water

Description

Chlor-alkali plants generally use a combination of techniques to reduce the generation of waste water, depending on and according to local conditions.

Technical description

Individual techniques are described in Sections 4.3.2.2.2 to 4.3.2.2.7.

Achieved environmental benefits

The achieved environmental benefits of this technique include:

- reduction of water consumption/waste water generation;
- reduction of salt consumption;
- reduction of chloride emissions.

Environmental performance and operational data

During the period from 2002 to 2010, the average waste water volume of chlor-alkali plants in the EU-27 and EFTA countries oscillated between 1.87 and 2.04 tonnes per tonne of chlorine produced [73, Debelle 2011].

A suitable combination of techniques results in a generation of waste water volumes of 0.5–1 m³/t chlorine produced [131, Germany 2003].

Example data from diaphragm and membrane cell plants with a low generation of waste water are shown in Table 4.14.

Table 4.14: Example data from diaphragm and membrane cell plants with low generation of waste water in the EU-27 in 2009 to 2011

Plant, location	Techniques used	Reference year	Annual average generation of waste water in m ³ /t chlorine produced	
			Brine purge	Total process waste water ⁽¹⁾
Anwil in Włocławek (Poland)	Recycling of condensates, bleach and sulphuric acid	2009	0	0.26
BASF in Ludwigshafen (Germany)	Brine recirculation; recycling of condensates, bleach and sulphuric acid	2011	0.15	0.66
Dow in Stade (Germany)	Brine recirculation; use of waste water for solution mining	2009	0	0
Ercros in Sabinánigo (Spain)	Brine recirculation; recycling of condensates, bleach and sulphuric acid	2009	0	0.14
Vinnolit in Gendorf (Germany)	Brine recirculation; recycling of condensates, bleach and sulphuric acid; no waste water from primary and secondary brine purification	2011	0.09	0.07
Vinnolit in Knapsack (Germany)	Brine recirculation; recycling of condensates and sulphuric acid; no waste water from primary and secondary brine purification	2011	0.07	0.36

⁽¹⁾ Includes: brine purge/depleted brine; backwashing water from filters from primary brine purification; regeneration of ion-exchange resins from secondary brine purification (brine softening); condensates from chlorine cooling, hydrogen cooling and caustic evaporation; bleach from the chlorine absorption unit; sulphuric acid from chlorine drying.
Excludes: regeneration of ion-exchange resins for process water demineralisation; cooling water; sealing water from pumps; wash water; rainwater

Source: [57, CAK TWG 2012]

Cross-media effects

Cross-media effects of individual techniques are described in Sections 4.3.2.2.2 to 4.3.2.2.7.

Technical considerations relevant to applicability

Technical considerations of individual techniques are described in Sections 4.3.2.2.2 to 4.3.2.2.7.

Economics

Economics of individual techniques are described in Sections 4.3.2.2.2 to 4.3.2.2.7.

Driving force for implementation

The driving forces for implementation of these techniques include:

- reduction of operating costs due to the reduced consumption of water and often salt;
- limited availability of water resources;
- environmental legislation.

Example plants

- Anwil in Włocławek (Poland), chlorine capacity 214 kt/yr;
- BASF in Ludwigshafen (Germany), chlorine capacity 385 kt/yr;
- Dow in Stade (Germany), chlorine capacity 1 585 kt/yr;
- Ercros in Sabiñánigo (Spain), chlorine capacity 30 kt/yr;
- Vinnolit in Gendorf (Germany), chlorine capacity 180 kt/yr;
- Vinnolit in Knapsack (Germany), chlorine capacity 250 kt/yr.

Reference literature

[1, Ullmann's 2006], [57, CAK TWG 2012], [73, Debelle 2011], [75, COM 2001], [131, Germany 2003]

4.3.2.3 Energy

4.3.2.3.1 High-performance bipolar membrane cells

Description

This technique consists in using high-performance bipolar membrane cells which make use of a serial electrical arrangement and small gaps between the electrodes.

Technical description

At the stage of designing and building a new electrolysis unit, the electricity consumption of the electrical equipment (transformers, rectifiers and busbars) and the electrolyzers can be optimised. The most important factors influencing electricity consumption are the cell technique used and the nominal current density.

Membrane cells generally consume less electricity than diaphragm or mercury cells (Section 3.3.4.3). Within the membrane cell technique, bipolar electrolyzers lead to lower ohmic losses compared to monopolar electrolyzers (Section 2.4.3). Diaphragm cells may, however, have lower electricity consumption than bipolar membrane cells if operated at low current densities (Figure 3.2). However, the caustic produced in diaphragm cells is of a lower quality than that of membrane cells and needs to be concentrated to 50 wt-% to be traded as a commodity. For this reason, practically all new electrolysis units are based on the bipolar membrane cell technique.

At the initial design of an electrolysis unit, a decision has to be made regarding the nominal current density. Higher current densities lead to higher electricity consumption (Figure 3.2) and thus higher operating costs. On the other hand, production rates per cell increase with current density, resulting in reduced investment costs. For a given total production rate, the chosen current density determines the number of electrolyzers and cells (example in Table 4.15) [63, Euro Chlor 2011].

Table 4.15: Number of cells and electrolyzers as a function of current density for a bipolar membrane cell plant with a chlorine capacity of 100 kt/yr

Current density (kA/m ²)	Number of electrolyzers	Number of cells per electrolyser	Total number of cells	Production rate in t Cl ₂ per cell and year
3	7	164	1 148	87
4	5	172	860	116
5	4	172	688	145
6	4	143	572	175

Source: [63, Euro Chlor 2011]

Achieved environmental benefits

The achieved environmental benefit of this technique is a reduction of energy consumption.

Environmental performance and operational data

The membrane cell technique has developed continuously since its broadscale implementation in the 1980s. The initial developments focused on anode and cathode coatings, membrane types, reduction of the cathode-membrane gap, electrolyte circulation in the cells, and gas release from electrodes and membranes. In the 1990s, the electric resistance in the cell structure was decreased by gradually switching from monopolar to bipolar electrolyser configurations. Due to these developments, there was also an increase in the maximum current density which can be applied. The impact of these developments on the specific electricity consumption is shown in Figure 4.3. A consumption reduction of 8–11 % at current densities of 3–4 kA/m² can be achieved by replacing old bipolar electrolyzers (1985) with more recent ones (2008) [63, Euro Chlor 2011].

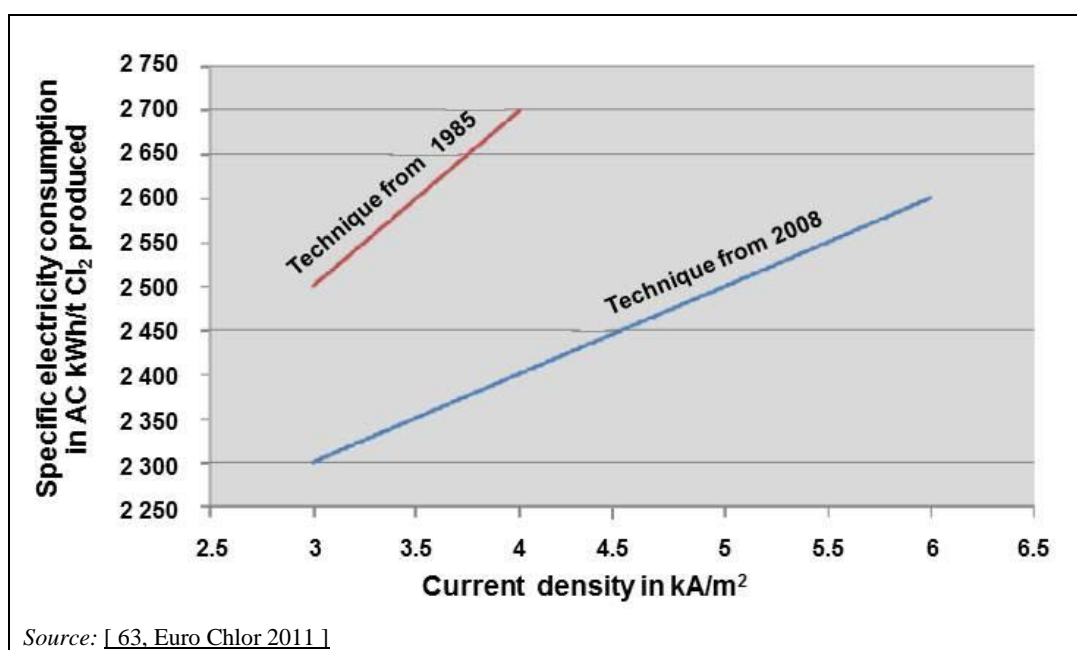

Figure 4.3: Impact of technological development of the bipolar membrane cell technique on specific electricity consumption and maximum current densities

Data on the electricity consumption of the latest bipolar membrane cell electrolyzers from different equipment suppliers under optimum start-up conditions are summarised in Table 4.16.

Table 4.16: Electricity consumption of bipolar membrane cell electrolyzers using the latest technique as a function of current density

Equipment provider	Unit	Current density in kA/m ²					
		3	4	5	6	7	8
Chlorine Engineers	DC kWh/t NaOH (100 %) produced ⁽¹⁾	1 890	1 950	2 000	2 060	2 110	2 170
INEOS		NI	NI	NI	2 100	NI	NI
Uhde		1 885	1 925	1 995	2 060	2 130	NI
Asahi Kasei		NI	1 955	NI	2 094	NI	NI
Chlorine Engineers	DC kWh/t Cl ₂ produced ⁽¹⁾ ⁽²⁾	2 130	2 200	2 260	2 320	2 380	2 450
INEOS		NI	NI	NI	2 370	NI	NI
Uhde		2 125	2 170	2 250	2 325	2 405	NI
Asahi Kasei		NI	2 205	NI	2 362	NI	NI

⁽¹⁾ For the start-up of a new plant under optimum conditions (e.g. brine quality, temperature, pressure), and depending on the type of membrane used. Excluding electricity losses caused by connections, rectifiers and transformers.
⁽²⁾ Assuming a production of 1.128 t NaOH (100 %)/t Cl₂ produced.
 NB: NI = no information provided.
 Source: [22, Uhde 2009], [133, Chlorine Engineers 2011], [134, INEOS 2011], [135, Asahi Kasei 2011]

Based on the information in Table 4.16 and assuming energy losses of 3 % due to electrical connections and current transformation/rectification (new electrical equipment), the expected electricity consumption values for new high-performance bipolar membrane cell electrolyzers under optimum start-up conditions can be derived and are summarised in Table 4.17.

Table 4.17: Expected electricity consumption of new bipolar membrane cell electrolyzers under optimum start-up conditions

Current density in kA/m ²	4	5	6	7
Electricity consumption in AC kWh/t Cl ₂ produced ⁽¹⁾	2 280	2 370	2 455	2 535

⁽¹⁾ Consumption values based on the production of chlorine, hydrogen and caustic soda for the start-up of a new plant under optimum conditions (e.g. brine quality, temperature, pressure), and depending on the type of membrane used. Assuming a production of 1.128 t NaOH (100 %)/t Cl₂ produced and energy losses of 3 % caused by connections, rectifiers and transformers (new electrical equipment). Excluding electricity consumption for chlorine liquefaction and auxiliary processes.
 Source: [112, Euro Chlor 2012]

Typically, the electricity consumption of a membrane cell unit increases by approximately 3–4 % after three years, due to the accumulation of impurities in the membrane and the ageing of the electrode coatings [1, Ullmann's 2006], [63, Euro Chlor 2011].

Cross-media effects

Raw materials and energy are consumed for the manufacture of the electrolyzers and the auxiliary equipment.

Technical considerations relevant to applicability

Generally, there are no technical restrictions to the applicability of this technique for new electrolysis units. In the case of an enlargement of an existing membrane cell unit, some modifications to auxiliary equipment might be necessary. Additional modifications are needed if the new electrolyzers are not or are only partially compatible with the existing ones. However, in the case of a replacement of an older membrane cell unit, not only the electrolyzers but also some of the auxiliary equipment will require replacement, especially when changing from a monopolar to a bipolar configuration. In the latter case, transformers, rectifiers and electrical facilities such as busbars cannot be reused and must be replaced. Many more adaptations are usually necessary in the case of a conversion of an existing mercury or diaphragm cell plant (Sections 4.1.2 and 4.2.3) [63, Euro Chlor 2011].

In some cases, robust operation of membrane cells with zero-gap structures (distance between electrodes ≤ 0.1 mm) is not possible due to a very poor salt quality. If a change of the salt source or further brine purification is too expensive, membrane cells with a narrow-gap structure will be employed instead [316, Euro Chlor 2012].

Despite the advantages of a bipolar configuration in terms of energy consumption, monopolar membrane cell electrolyzers might be used for new plants with a chlorine capacity of ≤ 20 kt/yr, as they are considered to be more robust and because the assembly can take place prior to shipping [293, Euro Chlor 2012].

Economics

Electricity accounts for about 50 % of the total cash production costs, which is the sum of the costs for raw materials, labour, maintenance, overheads and taxes [7, Euro Chlor 2010]. Typical production costs are shown in Table 4.18. Further information on investment costs can be found in Section 4.1.2.

Table 4.18: Typical production costs for a membrane cell plant with a chlorine production capacity of 500 kt/yr

Cost object	Unit	Unit/t Cl ₂ produced	EUR/unit	EUR/t Cl ₂ produced
Salt	t	1.7	30	51
Membranes	NI	NI	NI	20
Other raw materials	NI	NI	NI	32
Steam	t	2.08	18	37
Other utilities	NI	NI	NI	6
Electricity	AC kWh	3 000	0.07	210
Variable direct costs	NA	NA	NA	356
Operating costs	NA	NA	NA	6
Maintenance costs	NA	NA	NA	31
Plant overheads	NA	NA	NA	11
Taxes and insurances	NA	NA	NA	24
Fixed direct costs	NA	NA	NA	72
Total direct costs (variable+fixed)	NA	NA	NA	428
Corporate costs	NA	NA	NA	14
Total cash costs (direct + corporate)	NA	NA	NA	442
Depreciation	NA	NA	NA	121
Total production costs (cash + depreciation)	NA	NA	NA	563
NB: NA = not applicable; NI = no information provided.				
Source: [137, Euro Chlor 2010], [138, Prochemics 2007]				

At the planning and design stage of a new membrane cell unit, the economic optimum is sought by balancing investment and operational costs. The final result may be different due to variations of energy prices and investment costs in Member States and companies

[63, Euro Chlor 2011]. For example, electricity prices for an industrial consumption of 20 GWh/yr in EU Member States with chlor-alkali plants ranged from EUR 64.5/MWh in France to EUR 131.8/MWh in Italy in April 2011 (end-user prices excluding VAT) [139, Europe's Energy Portal 2011]. These figures are only indicative, because individual contracts with big consumers containing contract clauses on interruptibility and load-shedding could lead to lower prices.

The choice of design regarding the optimum current density is influenced by capital costs and electricity prices as shown in Figure 4.4. A current density of 4 kA/m² is the economic optimum for low relative capital costs and high electricity prices, while a current density of 6 kA/m² is the optimum for high relative capital costs and low electricity prices [63, Euro Chlor 2011].

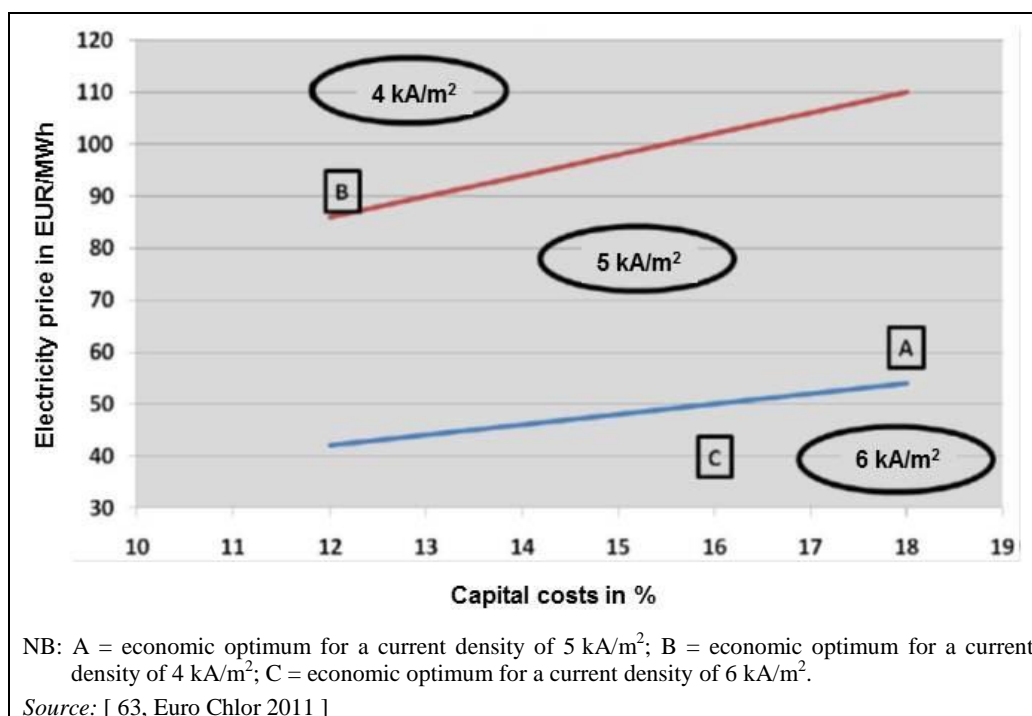

Figure 4.4: Choice of current density based on capital costs and electricity prices

After the optimisation of the nominal current density at the design stage of an electrolysis unit, the production rate and thus the corresponding operating current density is driven by the demand for the products. If there are variations in electricity prices according to the time of the day and/or the day of the week, the economic optimisation leads to load-shedding (variations of the instantaneous production rate) [300, Euro Chlor 2011].

A model calculation can be undertaken for the conversion of an existing electrolysis unit to a bipolar membrane cell unit using the latest technique. Assuming investment costs of EUR 500/t annual Cl₂ capacity, the simple payback times depending on electricity prices and savings in electricity consumption are shown in Table 4.19. For example, the conversion of a diaphragm or monopolar membrane cell plant with an electricity consumption of 2.8 AC MWh/t Cl₂ produced (the EU-27 and EFTA median for the electrolysis; Sections 3.3.4.3.3 and 3.3.4.3.4) to a new bipolar membrane cell plant with an electricity consumption of 2.4 AC MWh/t Cl₂ produced (at 6 kA/m²) would lead to electricity savings of 0.40 AC MWh/t Cl₂ produced. Electricity prices of EUR 50/MWh would then lead to a simple payback time of 24.9 years, while electricity prices of EUR 120/MWh would lead to a payback time of 10.4 years. In the case of a diaphragm cell plant concentrating the caustic to 50 wt-%, the payback time will be shorter, due to the reduced steam consumption. In the case of conversion of a mercury cell plant with an electricity consumption of 3.4 AC MWh/t Cl₂ produced (the EU-27 and EFTA median for the electrolysis), electricity savings of

1.0 MWh/t Cl₂ produced can be assumed. Electricity prices of EUR 50/MWh would then lead to a simple payback time of 10.0 years, while electricity prices of EUR 120/MWh would lead to a payback time of 4.2 years. However, the actual payback time will be longer due to the additional costs for steam.

Table 4.19: Cost calculation of simple payback times for the replacement of an electrolysis unit

Simple payback times in years for the replacement of an electrolysis unit											
Electricity savings in MWh/t Cl ₂ produced	Electricity costs in EUR/MWh										
	30	40	50	60	70	80	90	100	110	120	130
0.20	82.5	61.9	49.5	41.2	35.4	30.9	27.5	24.7	22.5	20.6	19.0
0.30	55.2	41.4	33.1	27.6	23.6	20.7	18.4	16.6	15.0	13.8	12.7
0.40	41.5	31.1	24.9	20.7	17.8	15.5	13.8	12.4	11.3	10.4	9.6
0.50	33.2	24.9	19.9	16.6	14.2	12.4	11.1	10.0	9.1	8.3	7.7
0.60	27.7	20.8	16.6	13.8	11.9	10.4	9.2	8.3	7.6	6.9	6.4
0.70	23.7	17.8	14.2	11.9	10.2	8.9	7.9	7.1	6.5	5.9	5.5
0.80	20.8	15.6	12.5	10.4	8.9	7.8	6.9	6.2	5.7	5.2	4.8
0.90	18.5	13.9	11.1	9.2	7.9	6.9	6.2	5.5	5.0	4.6	4.3
1.00	16.6	12.5	10.0	8.3	7.1	6.2	5.5	5.0	4.5	4.2	3.8
1.10	15.1	11.3	9.1	7.6	6.5	5.7	5.0	4.5	4.1	3.8	3.5
1.20	13.9	10.4	8.3	6.9	5.9	5.2	4.6	4.2	3.8	3.5	3.2
1.30	12.8	9.6	7.7	6.4	5.5	4.8	4.3	3.8	3.5	3.2	3.0
1.40	11.9	8.9	7.1	5.9	5.1	4.5	4.0	3.6	3.2	3.0	2.7
1.50	11.1	8.3	6.7	5.5	4.8	4.2	3.7	3.3	3.0	2.8	2.6
1.60	10.4	7.8	6.2	5.2	4.5	3.9	3.5	3.1	2.8	2.6	2.4
1.70	9.8	7.3	5.9	4.9	4.2	3.7	3.3	2.9	2.7	2.4	2.3
1.80	9.2	6.9	5.5	4.6	4.0	3.5	3.1	2.8	2.5	2.3	2.1
1.90	8.8	6.6	5.3	4.4	3.8	3.3	2.9	2.6	2.4	2.2	2.0
2.00	8.3	6.2	5.0	4.2	3.6	3.1	2.8	2.5	2.3	2.1	1.9

NB: The calculation is based on assumed investment costs for a new bipolar membrane cell unit of EUR 500/t annual Cl₂ capacity. Inflation and interest rates were not taken into account for the calculation.

The average requested payback time for energy saving equipment in industry is approximately three years [114, Delfrate and Schmitt 2010]. As can be seen from the aforementioned model calculations, the conversion of an existing electrolysis unit to another with lower energy consumption usually results in longer payback times.

Driving force for implementation

The driving forces for implementation of this technique include:

- business decision to increase the capacity of an existing plant;
- environmental legislation (for the conversion of a mercury cell plant);
- environmental, as well as occupational health and safety legislation (for the conversion of an asbestos diaphragm cell plant);
- improved quality of the caustic produced (for the conversion of a diaphragm cell plant);
- reduction of costs related to energy consumption.

Example plants

Example plants can be found among those that recently installed new membrane cell capacities:

- Ercros in Sabiñánigo (Spain), chlorine capacity 30 kt/yr, new membrane cell unit put into operation in 2009;
- Vinnolit in Gendorf (Germany), chlorine capacity 180 kt/yr, new membrane cell unit put into operation in 2009;

- Vinnolit in Knapsack (Germany), chlorine capacity 250 kt/yr new membrane cell unit put into operation in 2009.

Reference literature

[1, Ullmann's 2006], [7, Euro Chlor 2010], [22, Uhde 2009], [63, Euro Chlor 2011], [112, Euro Chlor 2012], [114, Delfrate and Schmitt 2010], [133, Chlorine Engineers 2011], [134, INEOS 2011], [135, Asahi Kasei 2011], [137, Euro Chlor 2010], [138, Prochemics 2007], [139, Europe's Energy Portal 2011], [300, Euro Chlor 2011]

4.3.2.3.2 High-performance membranes

Description

High-performance membranes used in membrane cells show low voltage drops and high current efficiencies, while ensuring mechanical and chemical stability under the given operating conditions.

Technical description

The membrane is the most critical component of the membrane cell technique. Its composition and structure is described in Section 2.4.2. Current density and cell voltage, and hence energy use, are greatly dependent on its quality. The ohmic drop through the membrane represents approximately 10–15 % of the total cell voltage and can increase during the life of a membrane, due to the accumulation of impurities. Manufacturers are continuously developing new high-performance membranes for use in narrow- and zero-gap electrolyzers (lower cell voltage, reduced energy use) [26, Euro Chlor 2010], [146, Arkema 2009], [333, Euro Chlor 2012].

The selection of the most suitable membrane for bipolar and monopolar, cells depends on a number of factors including [203, Eckerscham 2011]:

- electrolyser technology;
- power prices;
- durability;
- brine quality;
- customer specifications for caustic and chlorine;
- required lifetime of the membrane;
- energy consumption (current density);
- variations in electric load.

Achieved environmental benefits

The achieved environmental benefits of this technique include:

- reduction of energy consumption;
- reduction of chlorate emissions;
- reduction of salt and water consumption, as well as of chloride emissions, if the brine purge rate is determined by the chlorate concentration.

Environmental performance and operational data

New high-performance membranes show a cell voltage of approximately 3.0 V at a current density of 6.0 kA/m² (conditions: 0 mm gap, dimensionally stable anode, activated cathode, 32 wt-% NaOH, 200 g NaCl/l in the anolyte, 90 °C) and a current efficiency of > 95 %. The membrane lifetimes range between three and five years [26, Euro Chlor 2010], [136, Asahi Kasei 2008], [189, Nitini 2011]. In general, the cell voltage increases with current density and electrode distance. Membranes for monopolar electrolyzers show higher voltage drops than those for bipolar electrolyzers, due to the greater requirement for mechanical stability [26, Euro Chlor 2010], [188, DuPont 2006], [204, Asahi Glass 2011].

The electricity consumption of a membrane cell unit, as well as the formation of chlorate and oxygen, increases with the membrane age, due to the accumulation of impurities. If the brine purge rate is determined by the chlorate concentration, this may also lead to an increased consumption of water and salt [1, Ullmann's 2006], [63, Euro Chlor 2011], [121, MicroBio 2012].

The replacement of a membrane at the end of its service life by the best proven one compatible with the type of electrolyser used typically leads to electricity savings of ≤ 20 AC kWh/t Cl₂ produced [3, Euro Chlor 2011].

Cross-media effects

Some raw materials and energy are consumed for the manufacture of the membranes. The use of high-performance membranes may require additional brine treatment, which in turn may lead to an additional consumption of energy and ancillary materials and to the generation of additional waste.

Technical considerations relevant to applicability

Generally, there are no restrictions to the use of high-performance membranes in new membrane cells. Existing membrane cells can often be retrofitted, depending on the availability of improved membranes from the respective equipment provider under the given conditions [63, Euro Chlor 2011].

In some cases, the use of membranes with the lowest possible voltage drops is not possible due to insufficient chemical and/or mechanical strength [316, Euro Chlor 2012].

Economics

The average cost for membranes is approximately EUR 500/m². For a bipolar electrolyser operating at a current density of 6 kA/m² and a current efficiency of 95 %, the chlorine production rate is 64 t/(m²·yr). The average lifetime of a membrane is approximately four years. This results in a total chlorine production of 256 t/m² and specific membrane costs of EUR 2.0/t Cl₂ produced which represents about 1 % of the total variable costs for an Electrochemical Unit. If the membrane lifetime decreases to three years, this specific cost becomes EUR 2.6/t Cl₂ produced. For a monopolar membrane electrolyser operated at a current density of 3.5 kA/m², the specific costs are much higher (EUR 3.4/t Cl₂ produced). In practice, the aforementioned costs are double because the gaskets have to be simultaneously replaced with the membranes [26, Euro Chlor 2010].

When the costs for steam are higher than the costs for electricity, it is economically viable not to significantly reduce the cell voltage, since this would require compensation by additional heating of the brine with steam to maintain the operating temperature [26, Euro Chlor 2010].

Driving force for implementation

The driving forces for implementation of this technique include:

- replacement of membranes at the end of their lifetime;
- reduction of costs related to energy consumption;
- increased production rate;
- improvement of product quality;
- reduction of costs related to equipment and maintenance.

Example plants

High-performance membranes are generally used by membrane cell plants.

Reference literature

[3, Euro Chlor 2011], [22, Uhde 2009], [26, Euro Chlor 2010], [63, Euro Chlor 2011], [121, MicroBio 2012], [136, Asahi Kasei 2008], [188, DuPont 2006], [189, Nitini 2011], [203, Eckerscham 2011], [204, Asahi Glass 2011], [333, Euro Chlor 2012]

4.3.2.3.3 High-performance electrodes and coatings

Description

This technique consists in using electrodes and coatings with improved gas release (low gas bubble overpotential) and low electrode overpotentials.

Technical description

As in the development of high-performance membranes, manufacturers are continuously improving the performance of electrodes and coatings. Factors which are taken into account for the electrode structure include current distribution, gas release, ability to maintain structural tolerances, electrical resistance and the practicability of recoating. Coatings are optimised in terms of mechanical and (electro-)chemical robustness, as well as low overpotentials [21, Kirk-Othmer 1995].

At given anolyte conditions, a lower oxygen overpotential of a specific coating results in a lower production of chlorate. However, this does not change the current efficiency of the cells. While the formation of chlorate will be reduced, the formation of oxygen will increase [216, O'Brien et al. 2005, Section 7.5.9.4].

In the case of the diaphragm cell technique, the use of an expandable anode (Section 2.3.2) allows for the creation of a controlled 3-mm gap between the electrodes, thereby reducing energy consumption [21, Kirk-Othmer 1995]. Coatings used for anodes and cathodes are described in Section 2.3.2.

In the case of the membrane cell technique, the most important aspects of the electrode structures are the need to support the membrane and the gas release to the back of the electrode surface. The latter aims at reducing the electrical resistance caused by gas bubbles [1, Ullmann's 2006].

Achieved environmental benefits

The achieved environmental benefits of this technique include:

- reduction of energy consumption;
- reduction of chlorate emissions.

Environmental performance and operational data

The anode coatings of diaphragm cells have a lifetime of more than twelve years and the production of chlorine exceeds 240 t Cl₂/m² [1, Ullmann's 2006].

The typical lifetimes of anode and cathode coatings of membrane cells exceed eight years [22, Uhde 2009] [134, INEOS 2011].

The conversion to asbestos-free diaphragms at Arkema also involved the replacement of anodes and cathodes by expandable anodes and better performing cathodes, resulting in an overall reduction in electricity consumption for electrolysis of 3–4 % (Section 4.2.2) [31, Euro Chlor 2010]. The replacement of anodes in diaphragm cells by expandable anodes typically leads to electricity savings of ≤ 50 AC kWh/t Cl₂ produced [3, Euro Chlor 2011].

Cross-media effects

Some raw materials and energy are consumed for the manufacture of the electrodes and coatings.

Technical considerations relevant to applicability

Generally, there are no technical restrictions to the applicability of this technique for new electrolysis units. In the case of existing electrolysis units, some equipment suppliers offer the possibility to retrofit the cells [22, Uhde 2009]. The coatings can often be improved, depending on their availability from the respective equipment provider [63, Euro Chlor 2011].

The reduction of chlorate formation by using coatings with lower overpotential is restricted by the quality requirements of the produced chlorine [216, O'Brien et al. 2005, Section 7.5.9.4].

Economics

The costs for electrode recoatings may amount to several thousand EUR/m², depending on a potential removal of the mesh [3, Euro Chlor 2011].

Due to the investment costs, upgrades of electrodes and coatings are usually carried out when the electrodes require recoating.

Driving force for implementation

The driving forces for implementation of this technique include:

- recoating of electrodes;
- reduction of costs related to energy consumption;
- increased production rate;
- improvement of product quality;
- reduction of costs related to equipment and maintenance.

Example plants

- Kem One (formerly Arkema) in Fos-sur-mer (France), chlorine capacity of diaphragm cell unit 150 kt/yr;
- Kem One (formerly Arkema) in Lavéra (France), chlorine capacity of diaphragm cell unit 175 kt/yr.

Reference literature

[1, Ullmann's 2006], [3, Euro Chlor 2011], [21, Kirk-Othmer 1995], [22, Uhde 2009], [63, Euro Chlor 2011], [134, INEOS 2011], [216, O'Brien et al. 2005, Section 7.5.9.4]

4.3.2.3.4 High-purity brine**Description**

This technique consists in sufficiently purifying the brine to minimise contamination of the electrodes and diaphragms/membranes, which could otherwise increase energy consumption.

Technical description

Several types of impurities can have a detrimental effect on electrodes, diaphragms and membranes. The membrane cell technique is particularly sensitive to brine impurities (Table 2.4). The required brine purity is usually set out in the equipment specifications of the manufacturer.

Prior to designing the brine purification system, a full characterisation of the brine is usually carried out, followed by pilot trials for brine purification. Techniques for the removal of the most significant impurities via primary and secondary brine purification are applied in all chlor-alkali plants (Section 2.5.3). Some specific impurities such as strontium and aluminium can be accounted for during the design of the purification process. The temporary removal of mercury impurities might be necessary in the case of a conversion of a mercury cell plant to a membrane cell plant [143, Healy 2011].

Techniques to reduce the concentration of chlorate in the brine are described in Section 4.3.6.4, while the addition of barium salts for sulphate removal can be avoided by using nanofiltration (Section 4.3.6.2.2).

Achieved environmental benefits

The achieved environmental benefits of this technique include:

- reduction of energy consumption;
- reduction of chlorate emissions.

Environmental performance and operational data

No information provided.

Cross-media effects

Additional brine purification steps may lead to additional consumption of energy and ancillary materials and to the generation of additional waste.

Technical considerations relevant to applicability

Generally, there are no technical restrictions to the applicability of this technique.

Economics

Additional brine treatment leads to increased costs which may even exceed the savings due to reduced energy consumption and reduced maintenance costs. Sometimes it is more economical to select another salt source instead of modifying the brine purification.

Driving force for implementation

The driving forces for implementation of this technique include:

- reduction of costs related to energy consumption;
- reduction of costs related to equipment and maintenance.

Example plants

Primary brine purification is applied in all chlor-alkali plants. Secondary brine purification is applied in all membrane cell plants.

Reference literature

[3, Euro Chlor 2011], [143, Healy 2011]

4.3.2.3.5 Iron(III) meso-tartrate as an anti-caking agent

Description

This technique consists in using iron(III) *meso*-tartrate as an anti-caking agent instead of ferrocyanide whose decomposition products may damage the membrane and increase energy consumption.

Technical description

Sodium chloride is hygroscopic above 75 % relative humidity (critical humidity). Therefore, salt crystals can absorb enough moisture during storage to form a brine film on their surfaces. Subsequent water evaporation due to changes in temperature or air humidity causes recrystallisation of the brine film and the crystals bond together. The presence of small quantities of brine included in the crystals can also contribute to caking. Evaporated salt that exits the salt dryer at higher temperatures tends to undergo increased caking during cooling in silos. Caking hampers the handling of salt, in terms of loading/unloading and transport. To prevent caking, an aqueous ferrocyanide solution is frequently sprayed onto the salt. A final concentration of 2–20 ppmw of sodium ferrocyanide decahydrate ($\text{Na}_4[\text{Fe}(\text{CN})_6] \cdot 10 \text{H}_2\text{O}$) is

generally sufficient to prevent caking [66, Ullmann's 2010]. Ferrocyanide prevents caking by altering the crystallisation behaviour of sodium chloride [140, Giatti 2011].

The drawback of using ferrocyanide is that the complex is very stable, so the iron is not oxidised and precipitated as hydroxide during the primary brine purification. Ferrocyanide is therefore transferred to the electrolysis cell where it reacts with chlorine to form Fe(III) and cyanide. The latter is oxidised to cyanate, which may be further oxidised to ammonia [140, Giatti 2011]. Ammonia is an unwanted impurity in the brine, as it may lead to the formation of explosive nitrogen trichloride (Section 2.6.11.4). Iron is also unwanted in the membrane cell technique, as it deposits on the electrodes or on/in the membranes, leading to shorter lifetimes of electrodes and membranes, to reduced product qualities and to higher energy consumption (Table 2.4).

Ferrocyanide can be decomposed without the formation of nitrogen trichloride by adding chlorine to resaturated brine at temperatures higher than 80 °C and pH > 7, followed by primary purification to remove the liberated iron. However, this technique is rarely used due to the additional investment and operating costs [187, Debelle and Millet 2011], [315, Euro Chlor 2011].

Iron(III) *meso*-tartrate was introduced in 2004 as an alternative anti-caking agent. This complex is thermodynamically less stable so that iron is precipitated as hydroxide during primary brine purification. The residual tartrate is transferred to the electrolysis cells and fully oxidised to hydrochloric acid and carbon dioxide. No unwanted substances are formed [140, Giatti 2011].

Achieved environmental benefits

The achieved environmental benefits of this technique include:

- reduction of energy consumption;
- reduced formation of explosive nitrogen trichloride, which reduces the risk of accidental emissions if chlorine is liquefied.

Environmental performance and operational data

Test runs with ferrocyanide-containing brine at the AkzoNobel plant in Rotterdam (Netherlands) revealed a cell voltage increase of approximately 50 mV during the first month. No such increase was found with brine containing iron(III) *meso*-tartrate [140, Giatti 2011].

Cross-media effects

Some raw materials and energy are consumed for the production of iron(III) *meso*-tartrate. This anti-caking agent is biodegradable and decomposes quickly in soil or water [141, AkzoNobel 2011]. No halogenated organic compounds are formed in the brine circuit [140, Giatti 2011].

A drawback of the use of iron(III) *meso*-tartrate is that the iron content of the salt is increased by approximately 15 % compared to ferrocyanide, resulting in more solid waste from brine purification [315, Euro Chlor 2011].

Technical considerations relevant to applicability

Generally, there are no technical restrictions to the applicability of this technique.

The flow properties of iron(III) *meso*-tartrate deteriorate over time, therefore requiring careful stock control of the salt [316, Euro Chlor 2012].

Economics

Slightly higher amounts of iron(III) *meso*-tartrate are required compared to ferrocyanide. Cost savings due to a reduction of power consumption can be up to 5 % in the case of plants with brine acidification. Cost savings are negligible if the feed brine to the cells is alkaline [316, Euro Chlor 2012]. Further savings result from the longer lifetimes of electrodes and membranes and the reduced downtime due to maintenance, as well as increased product quality [141, AkzoNobel 2011].

Similar cost savings due to reduced energy consumption can also be achieved by a ferrocyanide decomposition unit [316, Euro Chlor 2012]. However, this technique is rarely used due to the additional investment and operating costs [315, Euro Chlor 2011].

In 2011, iron(III) *meso*-tartrate was only available in conjunction with the purchase of vacuum salt from a particular supplier.

Driving force for implementation

The driving forces for implementation of this technique include [141, AkzoNobel 2011]:

- reduction of costs related to energy consumption;
- reduction of costs related to equipment and maintenance;
- increased process safety.

Example plants

In 2011, AkzoNobel reported having used approximately 1 Mt/yr of vacuum salt with iron(III) *meso*-tartrate since 2005 in its own chlor-alkali plants [141, AkzoNobel 2011]. In 2010, a contract was signed between AkzoNobel and another European chlorine producer for 0.5 Mt/yr of vacuum salt with iron(III) *meso*-tartrate [142, AkzoNobel 2010].

Reference literature

[66, Ullmann's 2010], [140, Giatti 2011], [141, AkzoNobel 2011], [142, AkzoNobel 2010], [187, Debelle and Millet 2011], [315, Euro Chlor 2011], [316, Euro Chlor 2012]

4.3.2.3.6 Once-through brine system

Description

This technique consists in using a once-through brine system in which the depleted brine leaving the electrolysis cells is treated and discharged directly to a receiving water body instead of being reconcentrated and recirculated.

Technical description

A flow diagram of brine recirculation and once-through brine processes is shown in Figure 4.5.

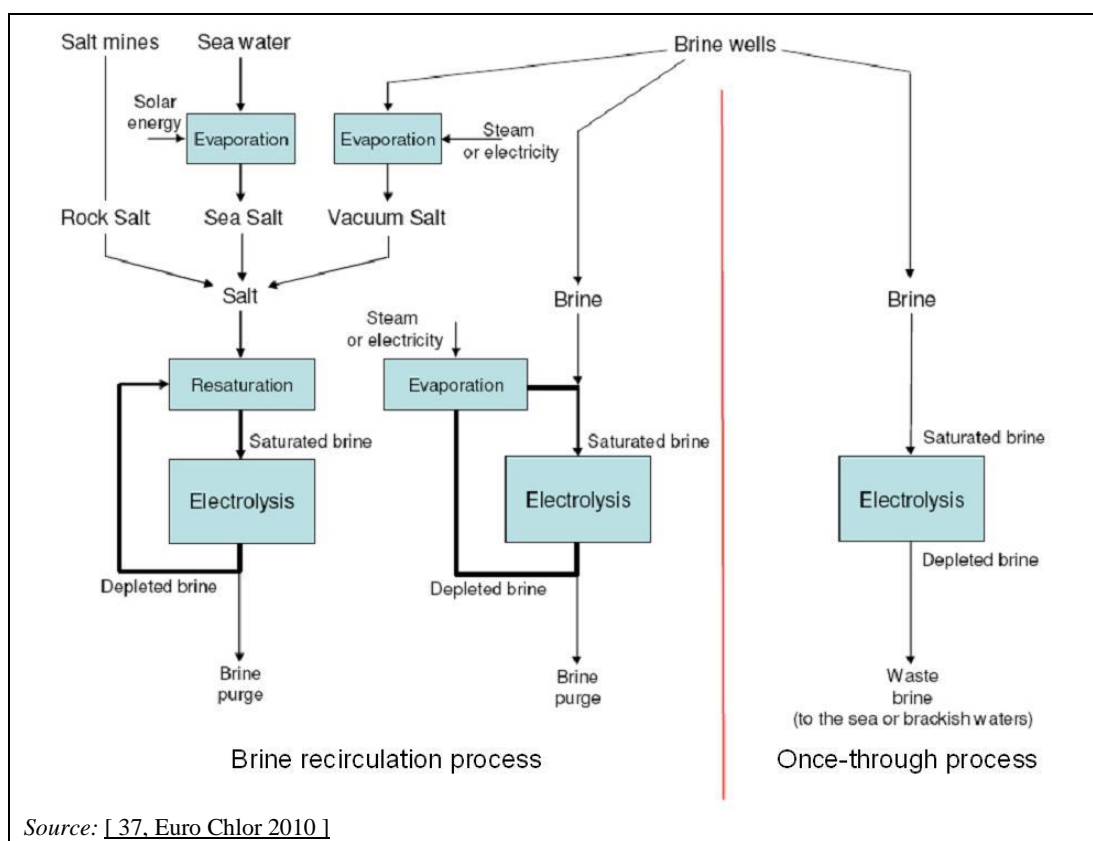

Figure 4.5: Flow diagram of brine recirculation and once-through brine processes

When solution-mined brine is used as a raw material for membrane cell plants, the once-through brine process allows for a reduction in energy consumption for the brine preparation. This is because three tonnes of water accompany each tonne of salt. With the usual brine recirculation process, there would be a need to remove that water to reconcentrate the depleted brine after electrolysis. This could be accomplished in a vacuum salt plant outside the electrolysis plant or in an evaporation unit integrated in the brine circuit of the electrolysis plant. When the once-through brine process is operated, this energy consumption can be avoided [37, Euro Chlor 2010].

Achieved environmental benefits

The achieved environmental benefit of this technique is a reduction in energy consumption.

Environmental performance and operational data

In a membrane cell plant, the water inputs to the brine circuit (via ancillary materials to the feed brine) are considerably lower than the water outputs (electro-osmosis, water in chlorine, brine purge). Indeed a considerable quantity of water (about two tonnes per tonne of chlorine) passes through the membrane from the anodic compartment to the cathodic compartment [37, Euro Chlor 2010]. Assuming a salt consumption of 1.7 tonnes per tonne of chlorine produced, this would result in about 3.2 tonnes of water to be evaporated per tonne of chlorine produced.

Evaporation could be carried out using steam in a multiple effect evaporation unit or using electricity via mechanical vapour recompression [37, Euro Chlor 2010]. Table 4.20 shows the related energy consumption figures.

Table 4.20: Energy consumption for brine reconcentration in membrane cell plants using solution-mined brine

Energy source	Unit	Multiple effect evaporation			Mechanical vapour recompression
		Number of effects			
		3	4	5	
Steam	t/t water evaporated	0.38	0.29	0.23	NA
	t/t Cl ₂ produced	1.25	0.93	0.75	NA
Electricity	kWh/t water evaporated	NA	NA	NA	45
	kWh/t Cl ₂ produced	NA	NA	NA	146
Primary energy ⁽¹⁾	GJ/t Cl ₂ produced	3.5	2.6	2.1	1.3

⁽¹⁾ Assuming an exergy of 2.5 GJ/t steam (at 10 bar and with condensate return at 90 °C), a steam generation efficiency of 90 % and a power generation efficiency of 40 %.
 NB: NA = not applicable.
 Source: [37, Euro Chlor 2010]

When the once-through brine process is operated, the energy consumption for brine reconcentration can be avoided [37, Euro Chlor 2010]. However, the related energy saving is reduced due to the fact that the full volume of fresh brine is preheated prior to electrolysis, while in brine recirculation plants only the make-up volume requires preheating [71, UK Environment Agency 2009]. In addition, the flowrate through the cells in plants with a once-through brine system is lower compared to plants with brine recirculation, in order to reduce raw material consumption. As a consequence, the temperature of the inflowing brine needs to be lower so that the cells are operated within their temperature limits. This effect leads to an increase in electricity consumption of approximately 3 % compared to plants with brine recirculation [3, Euro Chlor 2011].

Cross-media effects

A major disadvantage of the once-through brine process is that it uses about twice as much salt as a brine recirculation system, as half of it is discharged as depleted brine. Reported consumption values for once-through membrane cell plants amounted to 3.1 and 3.8 tonnes of salt per tonne of chlorine produced, compared to a median of 1.7 tonnes of salt per tonne of chlorine produced for plants with brine recirculation systems (Section 3.3.1) [57, CAK TWG 2012]. At the same time, 9–11 tonnes of water per tonne of chlorine produced are discharged which contain high concentrations of chloride.

In addition to the increased consumption of salt and water, a chlor-alkali plant with a once-through brine system shows significantly higher emission loads (in mass of pollutant per tonne of chlorine produced) compared to a plant with brine recirculation and with the same pollutant concentration in the effluent. In general, this concerns chlorate, bromate, halogenated organic compounds and chloride (approximately one tonne of chloride per tonne of chlorine produced), and in particular it concerns mercury in the case of mercury cell plants.

Technical considerations relevant to applicability

Generally, there are no technical restrictions to the applicability of this technique.

Economics

No information provided.

Driving force for implementation

The driving forces for implementation of this technique include:

- reduction of costs related to energy consumption for brine reconcentration;
- reduction of costs related to additional equipment necessary for brine recirculation.

Example plants

- Solvay in Póvoa de Santa Iria (Portugal), chlorine capacity 26 kt/yr;
- Ineos ChlorVinyls in Runcorn (United Kingdom), chlorine capacity of membrane cell unit 430 kt/yr.

Reference literature

[3, Euro Chlor 2011], [37, Euro Chlor 2010], [57, CAK TWG 2012], [71, UK Environment Agency 2009]

4.3.2.3.7 Use of hydrogen as a chemical reagent or as a fuel for combustion**Description**

These techniques consist in using the co-produced hydrogen from the electrolysis as a chemical reagent or fuel, instead of emitting it.

Technical description

The main utilisations of the co-produced hydrogen are [16, Agência Portuguesa do Ambiente 2010], [30, Euro Chlor 2010], [114, Delfrate and Schmitt 2010]:

- combustion to produce steam and/or electricity or to heat a furnace;
- chemical reactions such as:
 - production of ammonia;
 - production of hydrogen peroxide;
 - production of hydrochloric acid;
 - production of methanol;
 - reduction of organic compounds;
 - hydrodesulphurisation of petroleum;
 - hydrogenation of oils and greases;
 - chain termination in polyolefin production;
- production of electricity (and heat) in fuel cells.

At the Donau Chemie plant in Brückl (Austria), the hydrogen is used in stoichiometric excess to prevent emissions of chlorine in the production of hydrochloric acid in a chlorine-hydrogen burner at > 2000 °C, with subsequent absorption in demineralised water. The residual hydrogen is further scrubbed with caustic soda and then used to produce steam. The scrubbing solution is recycled to the hypochlorite production unit [314, Klima:aktiv 2008].

Achieved environmental benefits

The achieved environmental benefits of these techniques include:

- reduction of energy consumption;
- reduction of raw material consumption (if hydrogen would otherwise have to be produced by other techniques);
- reduction of hydrogen emissions (hydrogen could potentially act as an indirect greenhouse gas [335, IPCC 2007]).

Environmental performance and operational data

Current levels of emitted hydrogen as a share of the total hydrogen produced are presented in Section 3.4.6. On average, approximately 10 % of the hydrogen produced by chlor-alkali plants in the EU-27 and EFTA countries is emitted to the atmosphere. This corresponds to a use of 90 % of the co-produced hydrogen as a reagent or fuel [8, Euro Chlor 2011].

At the Donau Chemie plant in Brückl (Austria), the excess hydrogen from the hydrochloric acid production is treated for use as a fuel, resulting in savings of fuel oil of approximately 500 t/yr [314, Klima:aktiv 2008].

Cross-media effects

Some raw materials and energy are consumed if additional equipment is required to increase the share of used hydrogen.

Technical considerations relevant to applicability

An increase in the quantity of used hydrogen may require the installation of new equipment or the extension of existing equipment. Existing equipment may need to be adapted, as burning hydrogen leads to high temperatures [312, Euro Chlor and Spolchemie 2012].

The amount of co-produced hydrogen depends on the chlorine production rate, which often varies over time (e.g. load-shedding, see Section 4.3.2.3.1). Any use of the co-produced hydrogen needs to be compatible with these fluctuations [312, Euro Chlor and Spolchemie 2012].

During start-up and shutdown operations, the hydrogen produced usually does not have the required purity for its intended use. This is due to the fact that during plant shutdowns the relevant parts of the hydrogen network are flushed with nitrogen to prevent the formation of explosive gas mixtures (Section 3.4.7.1) [118, Solvay 2011], [333, Euro Chlor 2012].

Economics

The production of steam or chemicals depends on the existence of a respective demand. Although membrane cell plants often consume steam to bring the caustic produced to the commercial concentration of 50 wt-%, some have enough customers close to the production unit that directly use the 33 wt-% caustic from the cells [312, Euro Chlor and Spolchemie 2012].

Burning of the co-produced hydrogen to produce steam, which can then be used to generate electricity in gas turbines, requires considerable investments for boilers and turbines [312, Euro Chlor and Spolchemie 2012].

In the past, several companies bottled and marketed the co-produced hydrogen, but most of them have progressively sold this activity to specialised companies. In addition to the required investment (e.g. supplementary drying and purification of hydrogen, compressors, filling station, bottles) and operational costs, a commercial network with respective front- and back-offices, procedures for quality control, management of orders and deliveries, as well as accounting needs to be created. This is typically seen as unattractive for a 'non-core' business with a limited quantity of product compared to what industrial gas companies are handling [312, Euro Chlor and Spolchemie 2012].

At the Donau Chemie plant in Brückl (Austria), the payback time for the installation to treat the excess hydrogen from the hydrochloric acid production for use as a fuel was less than one year [314, Klima:aktiv 2008].

Driving force for implementation

The driving forces for implementation of these techniques include:

- reduction of costs related to energy consumption;
- reduction of costs related to equipment.

Example plants

All chlor-alkali plants in the EU-27 and EFTA countries use hydrogen to various degrees as a chemical reagent or fuel. Example plants include:

- Donau Chemie in Brückl (Austria), chlorine capacity 70 kt/yr.

Reference literature

[8, Euro Chlor 2011], [16, Agência Portuguesa do Ambiente 2010], [30, Euro Chlor 2010], [114, Delfrate and Schmitt 2010], [312, Euro Chlor and Spolchemie 2012], [314, Klima:aktiv 2008], [333, Euro Chlor 2012], [335, IPCC 2007]

4.3.3 Techniques for monitoring of emissions**4.3.3.1 Overview**

Generic issues of monitoring are described in the reference document on General Principles of Monitoring [70, COM 2003]. This section deals with specific issues of monitoring of emissions which are relevant to the chlor-alkali manufacturing industry. This includes the monitoring frequency and the available analytical methods. Some analytical methods are described in detail either because their use in the sector shows some peculiarities or because there are different methods used which can lead to different results. The monitoring of process parameters which are not linked to emissions is not covered in this section.

4.3.3.2 Common issues of all monitoring techniques

In order to avoid repetitions in the following sections, common issues for all monitoring techniques are described here.

Achieved environmental benefits

The achieved environmental benefit of monitoring is an improvement of environmental performance, by helping to maintain a proper operation of the plant, including its pollution prevention and control systems. Monitoring is a prerequisite for corrective actions.

Cross-media effects

Some equipment, ancillary materials and energy are required for the monitoring.

Technical considerations relevant to applicability

Generally, there are no technical restrictions to the applicability of monitoring techniques.

Driving force for implementation

The driving forces for implementation of this technique include:

- environmental legislation;
- process control.

4.3.3.3 Monitoring techniques and frequencies**Description**

Monitoring techniques and frequencies used vary considerably in chlor-alkali plants in the EU-27 and EFTA countries. The monitoring frequency is usually determined using a risk-based approach, which takes into account both the likelihood of exceeding an emission limit value and the resulting consequences [70, COM 2003].

Technical description

Table 4.21 provides an overview of monitoring techniques and frequencies.

Table 4.21: Monitoring techniques and frequencies for pollutants relevant to diaphragm and membrane cell plants

Environmental Medium	Substance(s)	Sampling point	Reported monitoring frequency ⁽¹⁾	Monitoring method	Standard/Analytical method
Air	Chlorine	Outlet of chlorine absorption unit	C , TPM, Q, SM, Y, 3Y	See Section 4.3.3.4	
	Chlorine dioxide		NRM	See Section 4.3.3.4	
Water	Bromate	Brine purge	TPM, M, SM ⁽²⁾	Ion chromatography	EN ISO 15061 [285, CEN 2001]
	Chlorate	Where the emission leaves the installation	D , W, TPM, M	Titration	[169, Ijspeerd et al. 1977]
				Ion chromatography	EN ISO 10304-4 [156, CEN 1999], [170, Desai et al. 1999], [171, Metrohm 2011]
	Chloride	Brine purge	D , W, TPM, M	Ion chromatography	EN ISO 10304-1 [172, CEN 2009]
				Flow analysis	EN ISO 15682 [173, CEN 2001]
				Silver nitrate titration (Mohr's method)	ISO 9297 [174, ISO 1989]
	Free chlorine	Close to the source/Where the emission leaves the installation	C , D , W, M	See Section 4.3.3.5	
	Halogenated organic compounds	Brine purge	D , W, M, SM ⁽²⁾	See Section 4.3.3.6	
	Sulphate	Brine purge	D , W, TPM, M	Ion chromatography	EN ISO 10304-1 [172, CEN 2009]
				Continuous flow analysis	ISO 22743 [176, ISO 2006]
Relevant heavy metals (e.g. nickel, copper)	Brine purge	W, TPM, M, Q, SM ⁽²⁾	Inductively coupled plasma optical emission spectrometry	EN ISO 11885 [339, CEN 2007]	
			Inductively coupled plasma mass spectrometry	EN ISO 17294-2 [340, CEN 2003]	

⁽¹⁾ Information taken from [57, CAK TWG 2012]. See also Chapter 3.
⁽²⁾ Data from less than 10 plants.

NB: 3Y = once every three years; C = continuous; D = daily; M = monthly; NI = no information provided; NRM = not routinely measured; Q = quarterly; SM = six-monthly; TPM = twice per month; W = weekly, Y = yearly. Letters in bold indicate measurement frequencies which are most commonly used.

Environmental performance and operational data

No information provided.

Economics

No information provided.

Example plants

Most of the parameters listed in Table 4.21 are frequently measured by diaphragm and membrane cell plants in the EU-27 and EFTA countries. Chlorine dioxide in air, as well as bromate and halogenated organic compounds in water, are less frequently measured.

Reference literature

[57, CAK TWG 2012], [70, COM 2003], [156, CEN 1999], [169, Ijspeerd et al. 1977], [170, Desai et al. 1999], [171, Metrohm 2011], [172, CEN 2009], [173, CEN 2001], [174, ISO 1989], [176, ISO 2006], [285, CEN 2001], [339, CEN 2007], [340, CEN 2003]

4.3.3.4 Monitoring of chlorine and chlorine dioxide in air

Issues of general relevance for all monitoring techniques are described in Section 4.3.3.2.

Description

Two categories of monitoring techniques for chlorine in air are generally used. The first is based on the absorption of chlorine in a liquid, with subsequent wet chemical analysis, while the second is based on direct measurements in the gas phase with electrochemical cells. Other oxidising species, such as chlorine dioxide, are frequently included in the measurement results, depending on the analytical method employed [67, Euro Chlor 2010].

Technical description

The absorption of gaseous chlorine in an aqueous solution is frequently carried out by using a solution of sulphamic acid (H_3NSO_3), leading to the formation of stable chloramines. The level of chloramines is subsequently determined with methods quantifying total chlorine, such as those using *N,N*-diethyl-1,4-phenylenediamine (DPD) (Section 4.3.3.5). Chloramines may also react with iodide in slightly acidic solution, resulting in the formation of tri-iodide, which can be measured photometrically. These two methods are applicable to chlorine concentrations of $0.30\text{--}7.0\text{ mg/m}^3$ ($0.1\text{--}2.3\text{ ppmv}$) with sampled air volumes of 15 l. Other oxidising species such as bromine and iodine are included in the measurement [67, Euro Chlor 2010].

Alternatively, the chloramines react with iodide to form iodine and chloride, with subsequent quantification of the latter using a chloride-selective electrode. The limit of quantification using this method is 0.14 ppmv when using sample volumes of 15 l, with an overall measurement uncertainty of $\pm 5\%$ in the range of $0.56\text{--}2\text{ ppmv}$. Other oxidising species interfere with the measurement [181, USDOL-OSHA 1991]. Chlorine and chlorine dioxide can be determined simultaneously by absorption in a potassium iodide solution, with subsequent titration using thiosulphate (iodometry) [182, USDOL-OSHA 2011]. Chlorine dioxide alone can be measured by absorption in a weak basic potassium iodide solution. Under these conditions, chlorite (ClO_2^-) is formed which can be quantified by ion chromatography (chlorite oxidises iodide only in acidic solutions). The limit of quantification of this method is 1 ppbv when using 120-l samples, and 18 ppbv when using 7.5-l samples, with an overall measurement uncertainty of $\pm 20\%$ in the range of $58\text{--}202\text{ ppbv}$ [183, USDOL-OSHA 1991].

Another possibility for measuring chlorine is its absorption in a solution containing methylorange. The bleaching of the latter is measured with photometry. The methylorange method can be used in the concentration range of $0.06\text{--}5\text{ mg/m}^3$, with an overall measurement uncertainty of $\pm 10\%$ at 4.5 mg/m^3 [179, VDI 1979]. Alternatively, absorption is carried out in a potassium bromide solution. The resulting bromine is quantified with iodometry. The bromide-iodide method can be used in a concentration range of $0.7\text{--}250\text{ mg/m}^3$ [180, VDI 1980].

Another option to measure chlorine is to pass the sample through a filter and dilute sulphuric acid into a dilute sodium hydroxide solution. Sodium thiosulphate is subsequently added to the latter solution and the resulting chloride is measured by ion chromatography. The analytical detection limit is approximately 0.1 ppm, equivalent to 0.3 mg/m^3 [337, US EPA 1988]. This

method is used in Flanders (Belgium) within a validated range of chlorine concentrations of 0.5–15 mg/m³ [151, VITO 2010].

Field and portable instruments for the direct monitoring of chlorine in air are usually based on electrochemical cells which measure all halogens. Some instruments are equipped with a pump to bring the ambient air to the sensor, while others are directly exposed to the air (mainly for field analysers and personal monitors) without the requirement for minimal air movement speed. Electrochemical cells can measure chlorine concentrations from < 1 to 100 mg/m³. The limit of detection is usually approximately 0.3 mg/m³, with a measurement uncertainty of approximately ± 5 % and a response time of approximately 10 seconds. In case of saturation of the sensor, some time is needed to recover the full sensitivity. Other oxidising species such as bromine and chlorine dioxide may be included in the measurement [67, Euro Chlor 2010]. Electrochemical cells are often used as detectors, to ensure that chlorine concentrations at the point of measurement do not exceed threshold values.

Gas detection tubes are another possibility for measuring chlorine and chlorine dioxide. A defined quantity of gas is suctioned through a tube containing a substance on a solid carrier material. The substance reacts by changing its colour, and the concentration of chlorine is then read off the colour scale on the tube. Detection limits are typically around 0.6 mg/m³ [154, Dräger 2009].

Other techniques such as UV-spectrophotometry, mass spectrometry, ion mobility spectrometry and papertape-based photometers may become of interest in the future [67, Euro Chlor 2010].

The calibration of the analytical techniques described above is usually based on molecular chlorine (oxidation number 0). Because of the fact that chlorine dioxide contains only one chlorine atom and its oxidation number is +IV, response factors differ. If both chlorine and chlorine dioxide are converted to chloride during the analytical measurement, then 1 mol of ClO₂ gives 5 / 2 = 2.5 times as much signal as 1 mol of Cl₂. In other words, 1 ppmv of ClO₂ leads to a measurement result of 2.5 ppmv of Cl₂. Taking into account the molecular weights, 1 mg/m³ of ClO₂ therefore leads to a measurement result of (2.5 × 70.90 / 67.45 =) 2.6 mg/m³ of Cl₂ [68, AkzoNobel 2007], [185, InfoMil 2011].

Environmental performance and operational data

Performance data of the different methods are included in their description in the preceding paragraphs.

Economics

Gas detection tubes are easy to operate and cheaper if monitoring is carried out occasionally [154, Dräger 2009].

Example plants

All chlor-alkali plants frequently monitor chlorine concentrations, including both channelled and diffuse emissions. Instead of exact measurements, chlorine detectors with threshold alarm values are often used (indicative monitoring).

Reference literature

[67, Euro Chlor 2010], [68, AkzoNobel 2007], [151, VITO 2010], [154, Dräger 2009], [179, VDI 1979], [180, VDI 1980], [181, USDOL-OSHA 1991], [182, USDOL-OSHA 2011], [183, USDOL-OSHA 1991], [185, InfoMil 2011], [337, US EPA 1988]

4.3.3.5 Monitoring of free chlorine in water

Issues of general relevance for all monitoring techniques are described in Section 4.3.3.2.

Description

Chlorine in effluents is usually measured as free or total chlorine. The analytical method used determines which other oxidising species are included in the analytical result.

Technical description

According to EN ISO 7393–1, –2 and –3, free chlorine includes hypochlorite, hypochlorous acid and dissolved elementary chlorine, while total chlorine also includes organic and inorganic chloramines. In addition, other oxidising species such as hypobromite, hypobromic acid, and dissolved elementary bromine are included in free chlorine, while bromamines are only included in total chlorine [162, CEN 2000], [163, CEN 2000], [164, CEN 2000].

The determination of free chlorine according to EN ISO 7393–1 is based on the reaction with *N,N*-diethyl-1,4-phenylenediamine (DPD) to form a red substance, which is then titrated with ammonium iron(II) sulphate (Mohr's salt) until the red colour disappears. Total chlorine can be determined by adding an excess of potassium iodide [162, CEN 2000]. EN ISO 7393–2 is based on the same chemical reactions but the resulting red substance is quantified by spectrometry or by comparison with permanent colour standards. The method is intended to be used for routine control purposes [163, CEN 2000]. EN ISO 7393–3 specifies a method for the determination of total chlorine by reaction with potassium iodide to form iodine, which is instantaneously reduced by a known excess of thiosulphate. The unreacted thiosulphate is titrated with potassium iodate [164, CEN 2000].

Another way to monitor emissions of free chlorine is to measure the reduction potential, for example by using DIN 38404–C 6 [272, DIN 1984] or OENORM M 6618 [273, ASI 2005] (indicative monitoring). The relationship between the reduction potential and the residual concentration of free chlorine strongly depends on the waste water matrix, but can be established empirically [118, Solvay 2011].

According to ISO 5667-3, the maximum storage time before measuring chlorine is five minutes [150, ISO 2003].

Environmental performance and operational data

The DPD method according to EN ISO 7393–1 and –2 is applicable to chlorine concentration ranges of 0.03–5 mg/l, while the iodometric method according to EN ISO 7393–3 is less sensitive, with typical chlorine concentration ranges of 0.7–15 mg/l [162, CEN 2000], [163, CEN 2000], [164, CEN 2000]. The use of DPD has been extensively tested. In particular, its ability to provide unambiguous determinations of free and total chlorine, as well as the possibility to measure mono- and dichloramine and nitrogen trichloride, is considered important [165, EA UK 2008].

Economics

No information provided.

Example plants

In Germany, regulatory measurements of free chlorine in membrane cell plants are carried out according to EN ISO 7393–1 [161, Germany 2004]. In Austria, EN ISO 7393–1 and –2 are used for the determination of free chlorine [160, Austria 1996].

Reference literature

[70, COM 2003], [150, ISO 2003], [160, Austria 1996], [161, Germany 2004], [162, CEN 2000], [163, CEN 2000], [164, CEN 2000], [165, EA UK 2008], [272, DIN 1984], [273, ASI 2005]

4.3.3.6 Monitoring of halogenated organic compounds in water

Issues of general relevance for all monitoring techniques are described in Section 4.3.3.2.

Description

Halogenated organic compounds in effluents are usually measured as AOX (adsorbable organically bound halogens) and EOX (extractable organically bound halogens). These parameters are quantitative surrogate parameters, as described in the reference document on General Principles of Monitoring [70, COM 2003].

Technical description

The most commonly used method to measure AOX is the EN ISO 9562 standard. It is based on the adsorption of halogenated organic compounds on activated carbon, which is subsequently washed and burnt in pure oxygen. The hydrogen chloride, hydrogen bromide and hydrogen iodide thus formed are absorbed in a solution and quantified by argentometry (e.g. by using microcoulometry). The method is applicable to test samples with AOX concentrations higher than 10 µg/l and chloride concentrations lower than 1 g/l [157, CEN 2004]. The use of this method for the analysis of waste water from chlor-alkali plants is impaired by the usually high chloride concentrations (Table 3.15). The standard allows sample dilution, but the resulting AOX concentrations may then be lower than the application limits of the standard.

An alternative method is to measure the EOX, which is based on a liquid-liquid extraction of the halogenated organic compounds with a non-polar solvent such as hexane, which is subsequently burnt in an oxyhydrogen torch. The hydrogen chloride, hydrogen bromide and hydrogen iodide thus formed are absorbed in a solution and quantified by argentometry (e.g. by using microcoulometry), photometry or by using ion-selective electrodes. The EOX method is not standardised on a European or international level, but some national standards in EU Member States exist, such as DIN 38409-H 4 [158, DIN 1984] and OENORM M 6614 [159, ASI 2001].

Another alternative consists in using a modified AOX method, which is described in the informative Annex A of the EN ISO 9562 standard. In this method, the halogenated organic compounds are first separated from inorganic halides by using solid phase extraction with a styrene-divinylbenzene copolymer. The resulting extract is subsequently analysed according to the traditional AOX method. The modified AOX method tolerates chloride concentrations of up to 100 g/l [157, CEN 2004].

Environmental performance and operational data

In 2011, a comparison of the three aforementioned monitoring methods for halogenated organic compounds in waste water from a membrane cell plant was carried out (Table 4.22).

Table 4.22: Concentrations of halogenated organic compounds in waste water from a membrane cell plant using three different monitoring methods

Parameter	Standard	Unit	Sampling date		
			21/01/2011	22/01/2011	23/01/2011
Chloride	NI	g/l	20	19.8	27.9
AOX	EN ISO 9562 (after dilution)	mg/l	0.84	4.15	10.1
EOX	NI	mg/l	0.026	0.020	0.14
AOX	Annex A of EN ISO 9562	mg/l	0.28	0.29	0.40
NB: NI = no information provided. Source: [155, WRUSS 2012]					

As can be seen from the table, the traditional AOX method resulted in large variations in the concentrations of halogenated organic compounds over a three-day period (a factor of more than 10), while these variations were much smaller when the EOX or modified AOX method were used. These large variations are unusual for waste water discharges from chlor-alkali plants and are probably due to the high chloride concentrations of the samples. It seems as if chloride affected the measurements even though the samples were diluted prior to analysis.

The EOX measurements led to lower concentrations of halogenated organic compounds than the modified AOX method, very likely because only non-polar compounds are extracted from the aqueous phase.

Economics

The costs for the modified AOX method according to Annex A of EN ISO 9562 are approximately three times higher than for the traditional AOX method [160, Szolderits 2012].

Example plants

In Germany, regulatory measurements of halogenated organic compounds in chlor-alkali plants are carried out by using the AOX method according to EN ISO 9562 when chloride concentrations are below 5 g/l, and by using the modified AOX method according to the informative Annex A of EN ISO 9562 when chloride concentrations are above 5 g/l [161, Germany 2004]. In Austria, the modified AOX method according to Annex A of EN ISO 9562 has been used for waste water from chlor-alkali plants since 2012 [160, Szolderits 2012].

Reference literature

[70, COM 2003], [155, WRUSS 2012], [157, CEN 2004], [158, DIN 1984], [159, ASI 2001], [160, Szolderits 2012], [161, Germany 2004]

4.3.4 Techniques to prevent or to limit the environmental consequences of accidents and incidents

Description

The techniques described in this section aim at preventing or reducing emissions of chlorine to air and water from accidents and incidents.

Technical description

Chlorine is amongst other things classified as toxic if inhaled and very toxic to aquatic life [76, Regulation EC/1272/2008 2008]. Chlor-alkali plants fall under the scope of the Seveso II and Seveso III Directives if chlorine is present in quantities equal to or in excess of 10 t. The Seveso II Directive is repealed with effect from 1 June 2015. The Directive requires the operator to take all measures necessary to prevent major accidents involving dangerous substances and to limit their consequences for human health and for the environment. In particular, a major-accident prevention policy needs to be designed and implemented. If chlorine is present in quantities equal to or in excess of 25 t, the Directive also requires the operator to produce a safety report and an internal emergency plan [280, Seveso II Directive (96/82/EC) 1996], [338, Directive 2012/18/EU 2012]. Although a large majority of the chlor-alkali plants in the EU-27 and EFTA countries falls under the scope of the Seveso Directives, some smaller plants do not.

In hazard and risk assessment studies, the design of chlor-alkali plants and equipment and the operating and maintenance routines are examined in detail to reduce the risks for human health and for the environment as much as possible. The most important substance to consider is chlorine. Preventative techniques are the most important, although corrective and emergency techniques are also of importance. The design principles of the plant, scheduled maintenance and inspection, procedures and instrumentation (control systems) for operating the unit are covered, as well as hardware. An overview is given, below, of potential techniques that can be

applied to reduce the risks of operating a chlor-alkali plant, including the storage and loading of products. The required combination of techniques will depend on the local situation.

General techniques

General techniques to prevent or reduce chlorine emissions from accidents and incidents are related to the appropriate design and implementation of a safety management system. The principles of such a system are described in the EFS BREF [323, EC 2006] and in Annex III to the Seveso Directives [280, Seveso II Directive (96/82/EC) 1996] [338, Directive 2012/18/EU 2012].

In the chlor-alkali plant (all areas)

- i. In the chlor-alkali plant, techniques to prevent or reduce chlorine emissions from accidents and incidents include: correct choice of construction materials, based on the state of the chlorine (wet or dry, gas or liquid, pressure, temperature), e.g. carbon steel for dry gaseous or liquid chlorine, titanium or plastics for wet chlorine [56, Euro Chlor 2008], [326, Euro Chlor 2009];
- ii. regular inspections of equipment;
- iii. automated process control systems;
- iv. continuous detection of chlorine with threshold alarm values in the vicinity of chlorine-containing equipment and at the site boundaries; the chlorine detection system is periodically inspected and connected to an emergency power supply [325, InfoMil 2012];
- v. monitoring and control of substances that might lead to explosive mixtures;
- vi. continuous monitoring of hydrogen in gaseous chlorine from the cell room and after each liquefaction step [56, Euro Chlor 2008];
- vii. maintaining the hydrogen concentration in gaseous chlorine below 4 vol-% by limiting the ratio to which chlorine is liquefied, by adding dry dilution air (or nitrogen), or by reacting the hydrogen to hydrochloric acid [3, Euro Chlor 2011], [56, Euro Chlor 2008];
- viii. periodic monitoring of nitrogen trichloride in liquid chlorine [56, Euro Chlor 2008];
- ix. maintaining the nitrogen trichloride concentration in liquid chlorine below 20 mg/kg by using the techniques described in Section 4.3.5.3 [35, Euro Chlor 2012], [56, Euro Chlor 2008];
- x. maintaining temperatures of wet chlorine above 15 °C, to prevent the formation of chlorine hydrates [54, Euro Chlor 2010];
- xi. maintaining temperatures of dry chlorine during compression below 120 °C, to prevent chlorine-iron fires, unless the compressor is manufactured using special material that is suitable for higher temperatures [56, Euro Chlor 2008];
- xii. maintaining the water content in chlorine after drying below 20 mg/kg (including liquid chlorine) [56, Euro Chlor 2008];
- xiii. collection and direction of all chlorine-containing waste gases from sources such as brine dechlorination, chlorine liquefaction, storage and loading to the chlorine absorption unit, including during maintenance and emergency venting (Section 4.3.5.1);
- xiv. backup power supply systems to vital equipment in case the grid power fails;
- xv. manual emergency push buttons.

In the storage area

Frequently used techniques to prevent or reduce chlorine emissions from accidents and incidents in the storage area include [40, Euro Chlor 2002], [41, Euro Chlor 2002], [56, Euro Chlor 2008], [328, HSE 2009]:

- i. limitation of the overall liquid chlorine inventory to the minimum strictly necessary (e.g. by designing separate smaller production lines);
- ii. good pipework design to minimise its liquid chlorine content;
- iii. simplified layout to reduce the number of valves, pipes and connections;
- iv. appropriate design of storage tanks;
- v. stock tanks with pressure indicators, as well as weight or level indicators, all connected to an alarm system;
- vi. relief systems on each storage tank which:
 - (a) are connected to the chlorine absorption unit;
 - (b) may contain a buffer tank to ensure that the maximum relief flow is compatible with the chlorine absorption unit;
 - (c) contain a gas/liquid separator if the relief might contain a liquid;
 - (d) consist of two bursting discs placed back to back or of a relief valve that is protected against corrosion from chlorine by a bursting disc upstream; alternatively, the relief valve can be lined with a chlorine-resistant fluoropolymer so that no bursting disc is required;
 - (e) contain a high-pressure alarm installed between the two bursting discs or between the bursting disc and the valve;
- vii. placing of all storage tanks in a liquid tight bund of sufficient volume to take up the contents of the largest storage tank;
- viii. spare storage capacity in liquid chlorine storage tanks to accept liquid chlorine from any other storage tank; alternatively double-walled storage tanks in the case of low-temperature storage;
- ix. storage at low temperature (pressure below 2.5 bar) for large storage capacities and storage at ambient temperature (pressure above 2.5 bar) for small storage capacities.

Other examples of preventative and corrective or emergency techniques are given in Table 4.23.

Table 4.23: List of some preventative and corrective or emergency techniques associated with the storage of liquid chlorine

Storage tank hazards	Examples of preventative techniques	Examples of corrective or emergency techniques
Vessel failure due to overpressurisation (vapour padding/inert gases)	<ul style="list-style-type: none"> Physical tank protection Maintain stock tank pressure below the maximum admissible pressure 	<ul style="list-style-type: none"> High-pressure alarms on stock tanks Relief systems at appropriate settings and capacities
Vessel failure due to overpressurisation (liquid overfill)	<ul style="list-style-type: none"> Pump maximum discharge pressure at less than maximum admissible system pressure Design standards of pump, pipework and vessels 	<ul style="list-style-type: none"> Two independent level/weight alarms on receiving tank Pump trips at high level and/or pressure Pump can be tripped remotely
Internal explosion due to build-up of NCl_3	<ul style="list-style-type: none"> Never allow liquid chlorine to evaporate completely to dryness Brine quality control Monitoring of NCl_3 in liquid chlorine 	NI
Internal explosion due to hydrogen	<ul style="list-style-type: none"> No direct connection between a chlorine storage tank and a chlorine gas stream containing hydrogen Continuous purge of inert gas to storage tanks and from there to chlorine absorption unit 	NI
Internal explosion due to contamination with organics	<ul style="list-style-type: none"> Avoidance of use of solvents or organic drying agents 	NI
Internal explosion due to contamination with oil	<ul style="list-style-type: none"> Avoidance of use of oil or hydrocarbon greases Use of oil-free compressors in padding gas system 	NI
Fire due to chlorine/iron reaction	<ul style="list-style-type: none"> Use of appropriate materials Avoidance of 'hot work' areas (e.g. welding, burning) No flammable liquids or materials in the surroundings of storage areas 	NI
Corrosion due to chlorine/water reaction; internal corrosion	<ul style="list-style-type: none"> Check tare weight of tank Moisture control system in padding gas system Prevention of possible back-flow 	<ul style="list-style-type: none"> Alarm on padding gas moisture indicator Response by process operators to evidence of ferric chloride Chlorine monitors on cooling water side of heat exchangers (e.g. indirect via reduction potential)
Corrosion due to diluted sulphuric acid; internal corrosion	<ul style="list-style-type: none"> Check concentration of sulphuric acid after filtration Minimise content of sulphuric acid after drying chlorine gas Moisture control system 	<ul style="list-style-type: none"> Response by process operators to evidence of ferric sulphate
External corrosion	<ul style="list-style-type: none"> All stock tanks operated at temperatures below zero are insulated Vapour barriers 	<ul style="list-style-type: none"> Pressure vessel inspections include selective removal of insulation to permit inspection of external surfaces
Low temperature thermal stress	<ul style="list-style-type: none"> Tanks have to be stress-relieved to prevent failure from high induced stress Avoidance of excessive physical force on valves Use of steel resilient at low temperature ($-40\text{ }^\circ\text{C}$) 	NI
Pump failure	<ul style="list-style-type: none"> Pump design specifications respected 	<ul style="list-style-type: none"> Chlorine detectors installed close to the pump
NB: NI = no information provided.		
Source: [56, Euro Chlor 2008], [324, Euro Chlor 2003]		

In the loading area

In any **liquid** chlorine loading (or unloading) system, the weakest link is the connection between the static plant and the mobile tank.

Only a risk assessment study, proper to each installation, can give the most likely causes of accidents and incidents during loading and the most appropriate techniques to prevent and reduce chlorine emissions from them. Frequently used techniques include [327, Euro Chlor 2012], [328, HSE 2009]:

- i. provision of a loading platform with at least two easy accesses via staircases;
- ii. placing of the mobile tank on a weighbridge to allow control during the operation and prevent overfilling;
- iii. appropriate connection between the storage tank and the mobile tank:
 - (a) use of articulated arms with a diameter of 25–50 mm, flexible hoses made of high nickel alloys with diameters of up to 50 mm, flexible steel pipes in mild steel with diameters of up to 50 mm or flexible copper pipes with diameters of up to 25 mm;
 - (b) avoidance of use of PTFE hoses;
- iv. remotely or automatically controlled valves on the mobile tank and between the storage tank and the flexible connection; remotely controlled valves can be closed from two different locations; automatically controlled valves close automatically upon pressure drop or chlorine release;
- v. purging of the connections with dry inert gas after use and storage under inert gas to prevent corrosion due to atmospheric moisture.

Other examples of preventative and corrective or emergency techniques are given in Table 4.24.

Table 4.24: List of some preventative and corrective or emergency techniques at loading areas of a chlor-alkali plant

Loading area hazards	Examples of preventative techniques	Examples of corrective or emergency techniques
Tank overfill	<ul style="list-style-type: none"> • Continuous measurement of the total weight of the mobile tank on a weighbridge • Automatic closure of filling valve at the end of the loading operation • Check-weighing on a second weighbridge after the loading operation 	<ul style="list-style-type: none"> • Warning for loading deviations and irregularities • Automatic pump shutdown • Chlorine detectors connected to alarms in the control room • Remotely controlled shutdown valves • Emergency procedures
Tank overpressurisation during filling	<ul style="list-style-type: none"> • Venting procedure to remove inert gases 	<ul style="list-style-type: none"> • Supply pump can be tripped manually or from control room
Corrosion due to chlorine/water reaction	<ul style="list-style-type: none"> • Check tare weight of tank • Moisture control system in padding gas system • Prevention of possible back-flow 	<ul style="list-style-type: none"> • Moisture analysis in chlorine gas and padding gas, with alarm • Response by process operators to evidence of ferric chloride in valves • Suction failure alarm in vent gas scrubbing system
Fire due to chlorine/iron reaction	<ul style="list-style-type: none"> • Use of appropriate materials • Avoidance of 'hot work' areas (e.g. welding, burning) • No flammable liquids or materials in the surroundings of loading areas 	NI
Fire due to contaminants (oil, organics)	<ul style="list-style-type: none"> • Avoidance of use of hydrocarbon oils, greases and solvents • Use of oil-free compressors in padding gas systems 	NI
Internal corrosion	<ul style="list-style-type: none"> • Moisture control system in liquid chlorine • Recognition of wet ferric chloride on valves by process operator 	NI
Collision with other rail/road tanks	<ul style="list-style-type: none"> • Applying the brakes of the transport vehicle and blocking the road or railway track during loading • Prevention of runaway rail wagons or tankers getting into filling area by interlocked rail retarders • Alarms linked to rail retarders 	<ul style="list-style-type: none"> • Emergency shut-off valves on storage tanks and mobile tanks initiated by push buttons
Rupture of the filling pipe	<ul style="list-style-type: none"> • Containment of the loading installation • Use of articulated arms or correctly specified flexible hoses and coils for chlorine transfer • Maintenance and inspection procedures 	<ul style="list-style-type: none"> • Emergency shut-off valves • Connection of dissipated chlorine gas from the transport vehicle to the chlorine destruction unit
Liquid chlorine in vent	<ul style="list-style-type: none"> • Alarm on mobile tank overfill • Definition of loading weight 	<ul style="list-style-type: none"> • Liquid chlorine in vent detector (alarm/trip) to alert operator • Increasing venting rate and draining liquid to vented tanks
Back-flow of chlorine into padding gas system	<ul style="list-style-type: none"> • Differential pressure control system on gas supply • Venting of mobile tank after filling to avoid subsequent overpressurisation due to warm-up 	<ul style="list-style-type: none"> • High and low pressure alarms on padding gas system • Padding gas chlorine detector and differential pressure control

NB: NI = no information provided.
Source: [324, Euro Chlor 2003], [327, Euro Chlor 2012]

Achieved environmental benefits

The achieved environmental benefits of these techniques are the prevention and reduction of chlorine emissions from accidents and incidents.

Environmental performance and operational data

No information provided.

Cross-media effects

Some raw materials and energy are consumed for the installation and operation of the techniques. Low-temperature storage requires the use of refrigerants, such as ammonia, carbon dioxide, chlorine or HFCs (Section 4.3.5.4). Thus, fugitive emissions of the employed refrigerant may occur. Furthermore, low-temperature storage requires more energy than storage at ambient temperature.

Technical considerations relevant to applicability

Generally, there are no technical restrictions to the applicability of these techniques.

Economics

The overall costs for techniques to prevent and reduce chlorine emissions from accidents and incidents depend on the site-specific combination that is used. Examples are given for some applied techniques [75, COM 2001]:

- SABIC (formerly General Electric Plastics) in Bergen op Zoom (Netherlands), where chlorine is used for the synthesis of phosgene: The cryogenic storage of chlorine includes two tanks with a capacity of 58 t each and one emergency tank. All tanks are kept at -34 °C and atmospheric pressure. The whole storage is contained inside a building of 8 000 m³. The chlorine absorption unit is 11 m high and 1.8 m in diameter. A fan allows a continuous venting of 5 000 m³/h. The estimated investment costs of the storage built in 1988 were approximately EUR 4.3 million (NLG 10 million, exchange rate 1998) and the estimated maintenance costs were approximately 2 % of the building costs.
- INEOS ChlorVinyls (formerly ICI) in Wilhelmshaven (Germany), large-quantity chlorine storage: Two tanks with a capacity of 1 600 t each and one emergency tank. Chlorine is stored in steel tanks enclosed within a shell constructed of a steel/polyurethane/aluminium sandwich material. This storage was built in the 1970s and cost approximately EUR 7.7 million (approximately DEM 15 million). This storage was the solution at that time to a specific situation; today it might not have been built for such large quantities.
- Arkema (formerly ATOCHEM) in Jarrie (France), loading area: Containment of a separate loading area (2 × 58 t railway tanks), chlorine absorption unit and water spray equipment. The costs were approximately EUR 1.5 million (September 1998).

Driving force for implementation

The driving forces for implementation of this technique include:

- environmental legislation;
- occupational health and safety legislation;
- safeguarding of invested capital.

Example plants

Techniques to prevent or reduce chlorine emissions from accidents and incidents are used by all chlor-alkali plants in the EU-27 and EFTA countries. The options chosen by the operator differ, depending on the plant location (proximity of residential areas for example), the stored quantities on site and/or the quantity of chlorine directly consumed.

Reference literature

[3, Euro Chlor 2011], [35, Euro Chlor 2012], [40, Euro Chlor 2002], [41, Euro Chlor 2002], [54, Euro Chlor 2010], [56, Euro Chlor 2008], [75, COM 2001], [280, Seveso II Directive (96/82/EC) 1996], [323, EC 2006], [324, Euro Chlor 2003], [325, InfoMil 2012], [326, Euro Chlor 2009], [327, Euro Chlor 2012], [328, HSE 2009], [338, Directive 2012/18/EU 2012]

4.3.5 Techniques to reduce emissions to air

4.3.5.1 The chlorine absorption unit

Description

This technique consists in reducing channelled emissions of chlorine to air by using a wet scrubber containing an alkaline solution (e.g. caustic soda) and using either packed towers or ejector systems.

Technical description

A general description of a wet scrubber can be found in the CWW BREF [124, EC 2003].

The purpose of the chlorine absorption unit is to avoid large emissions of chlorine gas to the environment during irregular plant operation and/or emergencies, and to treat all chlorine-containing waste gases during normal operation. The most common way to destroy the chlorine is to absorb it in weak caustic soda to produce sodium hypochlorite. The chemical reactions taking place are described in Section 2.6.12.2.

The absorption system can make use of batch or continuous systems, as well as of packed columns or ejectors [192, Euro Chlor 2011]:

- Packed columns are usually based on a countercurrent flow, with the chlorine gas entering the bottom of the column and the scrubbing solution entering the top. They have the advantage of larger scrubbing liquid retention volumes and good mass transfer. In case of emergencies, they can continue to absorb chlorine from a pressure relief system using scrubbing liquid stored in a gravity-fed head tank, even if the electricity supply fails. However, packed columns require an additional fan for sucking the chlorine vent and are more susceptible to plugging.
- Ejectors based on the Venturi principle use a high-pressure liquid stream to create a vacuum which sucks the chlorine into the eductor where it reacts with the scrubbing solution. They have the advantage of being simple, as only one pump is needed for the scrubbing liquid transport and gas suction. In addition, they remain effective at low and high chlorine concentrations in the vent gases and are less sensitive to salt deposition. However, ejectors show high power consumption and the mass transfer is limited to a single stage per unit, so that multiple stages or a combination with packed columns are usually required to provide adequate chlorine removal.

Figure 4.6 provides an example of a possible layout of a chlorine absorption unit with two absorption columns, while Figure 4.7 provides an example of an ejector system connected to an absorption column.

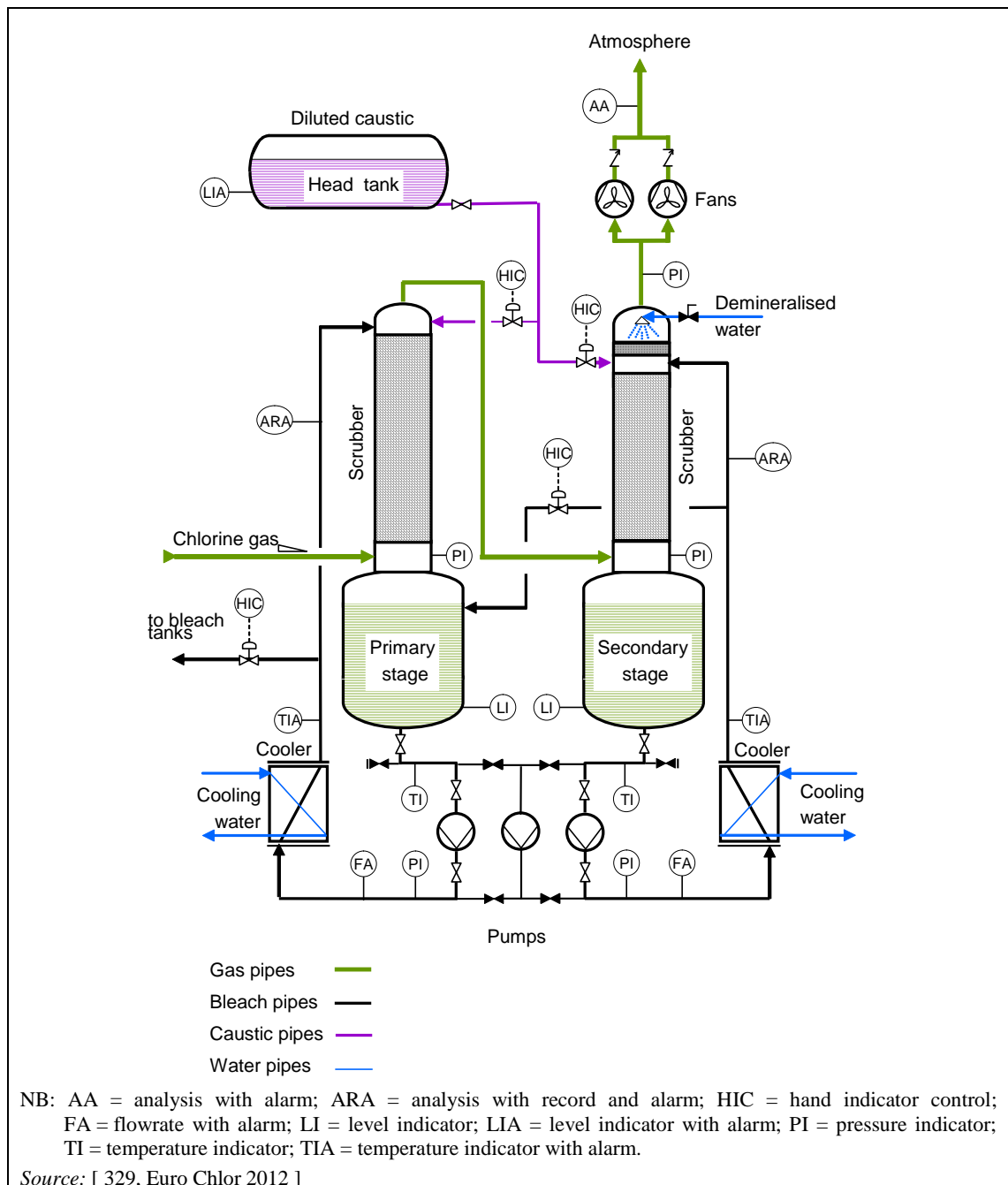

Figure 4.6: Flow diagram of a possible layout of a chlorine absorption unit with two absorption columns

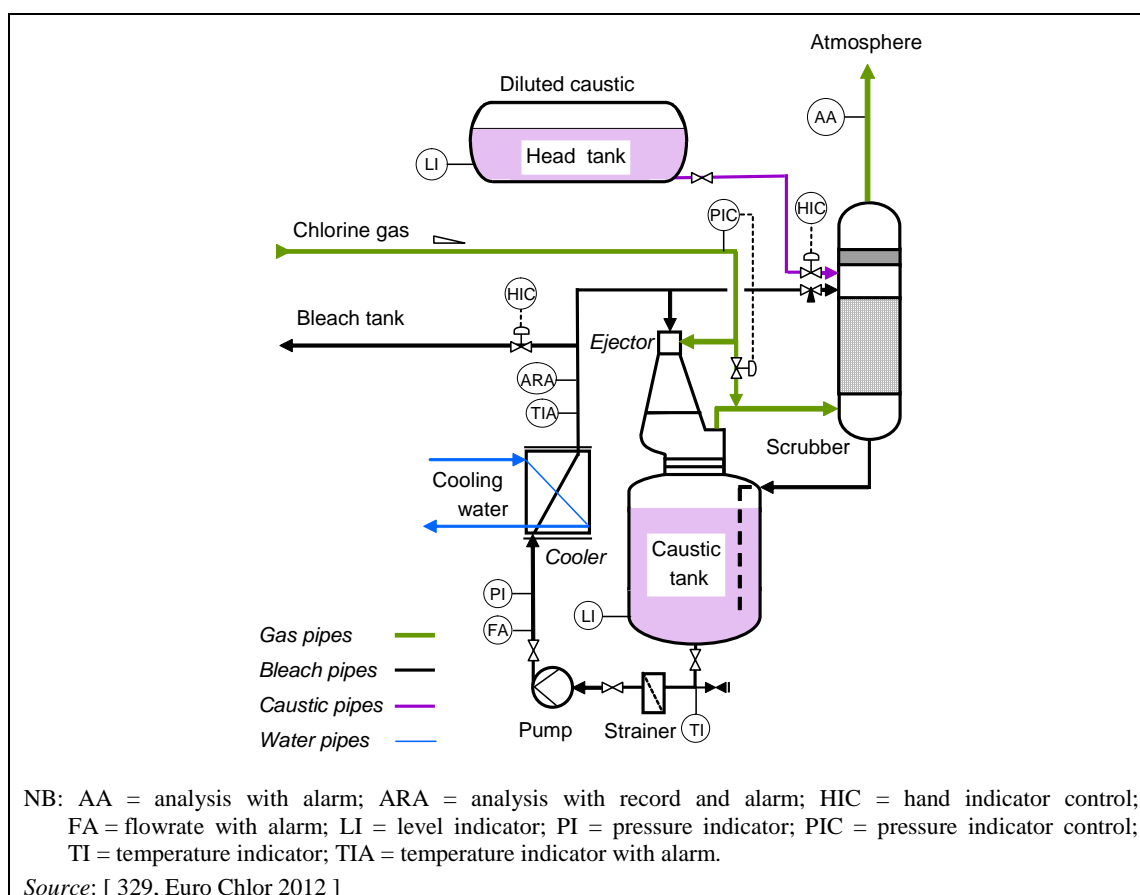

Figure 4.7: Flow diagram of a possible layout of a chlorine absorption unit with an ejector system connected to an absorption column

The design of an absorption system requires clear specifications of:

- the maximum quantity of chlorine;
- the composition of the gas stream;
- the maximum instantaneous flow.

Information on the composition of the gas stream includes temperature and pressure ranges, as well as the concentration ranges of other substances which may affect the process by, for example, reacting with the caustic soda (e.g. CO_2), potentially forming explosive gas mixtures (e.g. H_2) or altering the heat balance of the system (e.g. due to the condensation of water vapour from the gas stream, due to water evaporation from the scrubbing solution, and due to dilution with water) [192, Euro Chlor 2011].

In general, the size of the chlorine absorption unit is not linked to the chlorine production capacity of the plant but instead to the gas flow, which is mainly defined by the flow of inert gas injected to keep the hydrogen concentration below the explosivity limits. The majority of the plants work with gas flows of 2 000–8 000 m^3/h [336, Euro Chlor 2012].

The proper design, maintenance and operation of the chlorine absorption unit are based on a risk assessment study to avoid the discharge of major amounts of chlorine to the atmosphere during all possible situations. This can be achieved by, depending on the technique [192, Euro Chlor 2011]:

- sizing of the absorption unit for a worst case scenario (derived from a risk assessment), in terms of produced chlorine quantity and flowrate (absorption of the full cell room production for a sufficient duration until the plant is shut down);

- ii. sizing of the scrubbing liquid supply and storage capacity so as to ensure an excess at all times;
- iii. sizing of the column so as to prevent flooding at all times;
- iv. preventing the ingress of liquid chlorine into the absorption unit, for example by using knock-out pots in cases where some liquid chlorine can be present in the vent;
- v. preventing the backflow of scrubbing liquid into the chlorine system by using devices such as hydraulic guards and knock-out pots;
- vi. preventing the precipitation of solids in the absorption unit by choosing an appropriate scrubbing liquid; maintaining the sodium chloride content below 22 wt-% when using 18–22 wt-% sodium hydroxide;
- vii. using heat exchangers in the circulating absorbent to limit the temperature below 55 °C at all times to prevent the excessive formation of chlorate;
- viii. supplying dilution air to prevent the formation of explosive gas mixtures after chlorine absorption;
- ix. using construction materials which withstand the extremely corrosive conditions at all times;
- x. using backup equipment, such as an additional scrubber in series with the one in operation, an emergency tank with scrubbing liquid feeding the scrubber by gravity, standby and spare fans, standby and spare pumps;
- xi. providing an independent backup system (e.g. diesel generators or direct current batteries with an inverter) for critical electrical equipment such as the gas suction system, the scrubbing liquid circulation pumps, the key instruments for process control and the lighting;
- xii. providing an automatic switch to the backup system in case of emergencies, including periodic tests on this system and the switch;
- xiii. providing process control by monitoring the following parameters in connection with an alarm system:
 - (a) chlorine in the outlet of the scrubber and the surrounding area;
 - (b) temperature of the scrubbing liquids;
 - (c) reduction potential and alkalinity of the scrubbing liquids;
 - (d) suction pressure;
 - (e) flowrate of scrubbing liquids;
 - (f) pressures of pumping solutions, as well as chlorine process and relief headers;
 - (g) differential pressure at the inlet and outlet of packed columns;
 - (h) liquid levels in the storage and reaction tanks.

Achieved environmental benefits

The achieved environmental benefit of this technique is a reduction of emissions of chlorine and other oxidants to air.

Environmental performance and operational data

The environmental performance of a chlorine absorption unit basically depends on its layout, in the sense that the design determines the average concentration at the outlet [192, Euro Chlor 2011]. Current emission levels of chlorine from the absorption unit are presented in Table 3.23. The lowest maximum concentration reported was 0.05 mg/m³, and the lowest annual average concentration 0.024 mg/m³. Taking into account data reported as ranges and annual averages, it can be estimated that chlorine emissions from the absorption units covered by the survey were in 9 % of the cases ≤ 0.2 mg/m³ during normal operation, in 30 % of the cases ≤ 0.5 mg/m³, in 55 % of the cases ≤ 1.0 mg/m³, in 67 % of the cases ≤ 2.0 mg/m³ and in 76 % of the cases ≤ 3.0 mg/m³ [57, CAK TWG 2012]. Example data from well-performing plants are shown in Table 4.25.

Table 4.25: Example data from plants with low chlorine emissions from the chlorine absorption unit in the EU-27 in 2007 to 2011

Plant, location	Design of chlorine absorption unit	Chlorine concentrations in mg/m ³ ⁽¹⁾	Reference year	Reference conditions
AkzoNobel in Rotterdam-Botlek (Netherlands)	NI	< 0.1–1	2010	Continuous monitoring with electrochemical cells
CABB in Gersthofen (Germany)	Two ejectors and one absorption column	0.18–0.20	2007	Three individual measurements (half-hourly) with methyl orange method on one day at full plant load
Chimcomplex in Borzești (Romania)	NI	0.05–0.5	2009	Periodic measurements (half-hourly)
Dow in Schkopau (Germany)	Two ejectors and one absorption column	0.04–0.12	2008	Three individual measurements (half-hourly) with methyl orange method on one day at full plant load
		0.16–0.18	2011	
Hispanic in Martorell (Spain)	Two absorption columns	< 0.02–0.54	2011	Measurements every two weeks
MicroBio in Fermoy (Ireland)	Two absorption columns	< 0.6	2008 to 2011	Weekly measurements (half-hourly) with gas detection tubes; concentrations always below detection limit of 0.6 mg/m ³
PCC Rokita in Brzeg Dolny (Poland)	NI	0.02–0.05	2008	Two measurements per year
Solvay in Rheinberg (Germany)	Three absorption columns	0.3–0.4	2010	Three individual measurements (half-hourly) with methyl orange method on one day at full plant load
Solvay in Rosignano (Italy)	NI	0.21–0.35	2008	Two measurements (three-hourly) per year
Zachem in Bydgoszcz (Poland)	Three absorption columns	0.024 ⁽²⁾	2011	Measurement (half-hourly) with methyl orange method on one day

⁽¹⁾ Data refer to standard conditions (273.15 K, 101.3 kPa) after deduction of the water content at the outlet of the chlorine absorption unit.
⁽²⁾ Annual average value.
 NB: NI = no information provided.
 Source: [57, CAK TWG 2012]

For a plant with a typical gas flow of 3 000 m³/h, a reduction of the average chlorine concentration from 3 to 1 mg/m³ would result in an absolute reduction of chlorine emissions of approximately 53 kg/yr. If instead of an average chlorine concentration of 3 mg/m³, the plant usually achieved a chlorine concentration below 1 mg/m³ and only during 10–20 % of the time a concentration of 3 mg/m³ (high concentrations compared to the annual average usually occur when high hypochlorite concentrations are reached), then the absolute reduction of chlorine emissions would be approximately 5–10 kg/yr [336, Euro Chlor 2012]

The absorption unit at the AkzoNobel plant in Bitterfeld (Germany) is required to have the capacity to absorb the full cell room chlorine production for eight minutes, including during power failure. During this period, the plant has to be shut down. The permit furthermore requires the permanent availability of caustic soda in sufficient quantity and concentration, as well as redundant pumps for the scrubbing solution [69, Regierungspräsidium Dessau 1999].

Cross-media effects

Considerable quantities of raw materials and energy are consumed for the installation and operation of the absorption unit. The main ancillary material consumed is the corrosive scrubbing liquid (i.e. the caustic soda solution).

The bleach (solution of sodium hypochlorite) produced by the chlorine absorption unit usually has too low a concentration of active chlorine to be sold, but it can be used to feed the commercial hypochlorite production unit. In this case, no further emissions occur, although the consumer might discharge free chlorine from the bleach. When there is no demand for bleach and it cannot be recycled (Section 4.3.6.3.6), it has to be destroyed before it can be discharged. The effluent from the bleach destruction may have an adverse effect on the recipient water, depending on the technique used (Section 4.3.6.3).

Technical considerations relevant to applicability

Generally, there are no technical restrictions to the applicability of this technique. The achievement of lower residual chlorine concentrations in an existing plant generally requires the installation of an additional absorption column or ejector. Furthermore, additional pumps, pipes, tanks with scrubbing liquid, heat exchangers and instrumentation are needed and the performance of the fans needs to be increased to overcome the additional pressure drop [336, Euro Chlor 2012].

Economics

During the design stage of a new plant, lower chlorine emissions from the chlorine absorption unit can be achieved at a marginal cost increase, for example by increasing the height of the internal packing of the columns. However, reducing chlorine emissions in existing plants requires the installation of an additional absorption column or ejector at considerable costs [336, Euro Chlor 2012].

At the Solvay plant in Santo André (Brazil), investment costs for a new chlorine absorption unit with two stages amounted to approximately EUR 2.0 million in 2009 [336, Euro Chlor 2012].

At the AkzoNobel plant in Rotterdam-Botlek (Netherlands), the chlorine absorption unit was upgraded in 2000 to reduce emissions of chlorine from approximately 3 mg/m³ to less than 1 mg/m³. Investment costs amounted to approximately EUR 1.5 million. At that time, the plant had a chlorine capacity of 350 kt/yr, which was increased in the following years to 630 kt/yr without the need for further modification of the chlorine absorption unit, as the emissions of chlorine were still below 1 mg/m³ at its outlet [336, Euro Chlor 2012].

Driving force for implementation

The driving force for implementation of this technique is environmental, as well as health and safety legislation.

Example plants

All existing plants are equipped with chlorine absorption units. Example plants include:

- AkzoNobel in Rotterdam-Botlek (Netherlands), chlorine capacity 637 kt/yr;
- CABB in Gersthofen (Germany), chlorine capacity 45 kt/yr;
- Chimcomplex in Borzești (Romania), chlorine capacity 93 kt/yr;
- Dow in Schkopau (Germany), chlorine capacity 250 kt/yr;
- Hispavic in Martorell (Spain), chlorine capacity 218 kt/yr;
- MicroBio in Fermoy (Ireland), chlorine capacity 9 kt/yr;
- PCC Rokita in Brzeg Dolny (Poland), chlorine capacity 125 kt/yr;
- Solvay in Rheinberg (Germany), chlorine capacity 220 kt/yr;
- Solvay in Rosignano (Italy), chlorine capacity 150 kt/yr;
- Solvay in Santo André (Brazil), chlorine capacity 150 kt/yr;
- Zachem in Bydgoszcz (Poland), chlorine capacity 72 kt/yr, plant was shut down in 2012.

Reference literature

[57, CAK TWG 2012], [69, Regierungspräsidium Dessau 1999], [192, Euro Chlor 2011], [329, Euro Chlor 2012], [336, Euro Chlor 2012]

4.3.5.2 Scrubbing with hydrogen peroxide to reduce emissions of chlorine dioxide

Description

This technique consists in reducing emissions of chlorine dioxide to air from the chlorine absorption unit by using hydrogen peroxide. This can be achieved in a separate scrubber or by adding peroxide dosing equipment to the chlorine absorption unit.

Technical description

A general description of a wet scrubber can be found in the CWW BREF [124, EC 2003].

Small amounts of chlorine dioxide can be emitted to air from the chlorine absorption unit. Chlorine dioxide can be formed via two paths, one being a side reaction of chlorine or hypochlorous acid with chlorite (chlorite originates from the disproportionation of hypochlorite, see Section 2.6.12.2) [185, InfoMil 2011], [191, Lassche 2011], [192, Euro Chlor 2011], [193, Jia et al. 2000], [194, Gordon and Tachiyashiki 1991]:

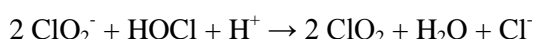
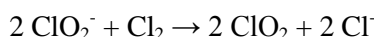

The formation of chlorine dioxide via this reaction is favoured by higher temperatures. It is also favoured by pH values below 7, where dissolved molecular chlorine or hypochlorous acid dominates over hypochlorite. These pH values can be caused by an insufficient surplus of sodium hydroxide to absorb chlorine, often due to local concentration gradients. Moreover, higher concentrations of non-condensable gases, such as oxygen and nitrogen in the waste gas, lead to increased stripping [185, InfoMil 2011], [191, Lassche 2011], [194, Gordon and Tachiyashiki 1991].

The other path of chlorine dioxide formation is the acidic reduction of chlorate [34, Solvay 2010], [192, Euro Chlor 2011]:

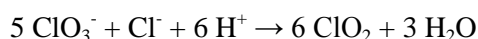

This reaction may take place during brine dechlorination in the case of high chlorate concentrations or during acidic chlorate reduction (Section 4.3.6.4.3) in the case of low temperatures and high concentrations of hydrochloric acid [192, Euro Chlor 2011].

Chlorine dioxide hardly dissolves in the produced bleach and is therefore continuously stripped out with the waste gas. The monitoring equipment usually measures both chlorine and chlorine dioxide (Section 4.3.3.4). Chlorine dioxide can be destroyed with hydrogen peroxide to produce chlorite, the latter remaining in the bleach [185, InfoMil 2011], [191, Lassche 2011]:



At the AkzoNobel plant in Rotterdam (Netherlands), a separate hydrogen peroxide scrubber was installed, while at the AkzoNobel plants in Delfzijl (Netherlands) and Ibbenbüren (Germany), peroxide dosing equipment was added to the chlorine absorption unit. In the latter case, the dosage of hydrogen peroxide is controlled by an analyser in the waste gas which starts when the chlorine dioxide concentration exceeds 0.7 mg/m^3 . The hydrogen peroxide is stored in an intermediate bulk container, which is placed on a liquid impermeable floor. The hydrogen peroxide has a concentration of approximately 35 wt-%. The inflow takes place automatically

via a pump and a flexible pipeline, which is connected to the circulation flow of the secondary chlorine scrubber, immediately after the cooler. A check valve prevents backflow. The pump is indirectly controlled by the signal from the chlorine analyser, resulting in a pulse dose. A continuous dosage is not possible because the chlorine dioxide concentration is not constant and the hydrogen peroxide concentration in the bleach needs to be as low as possible to increase the lifetime of the cooler and to maintain the quality of the produced bleach [68, AkzoNobel 2007], [185, InfoMil 2011].

Achieved environmental benefits

The achieved environmental benefit of this technique is a reduction of chlorine dioxide emissions to air.

Environmental performance and operational data

At the AkzoNobel plant in Delfzijl (Netherlands), hydrogen peroxide is added to the chlorine absorption unit. This reduces the chlorine dioxide concentration from 9–22 mg/m³ in untreated vent gas (corresponding to loads of 2.3–5.5 g/h and 0.18–0.44 g/t annual chlorine capacity) to less than 0.4 mg/m³ (corresponding to loads of 0.1 g/h and 8 mg/t annual chlorine capacity) at a flowrate of approximately 250 m³/h [68, AkzoNobel 2007], [185, InfoMil 2011].

Cross-media effects

Some raw materials and energy are consumed for the installation and operation of the scrubber or dosing equipment. In particular, the technique requires hydrogen peroxide that, depending on the concentration, can be oxidising and irritant/corrosive. The estimated consumption of 35 wt-% H₂O₂ at the AkzoNobel plant in Delfzijl (Netherlands) is approximately 2 m³ per month. In the case of a separate scrubber, waste in the form of a chlorite/chlorate containing hydrogen peroxide solution is generated [68, AkzoNobel 2007], [185, InfoMil 2011].

Technical considerations relevant to applicability

Generally, there are no technical restrictions to the applicability of this technique. The peroxide dosing equipment has the advantage that only a small modification of the system is needed compared to a separate scrubber [68, AkzoNobel 2007], [185, InfoMil 2011].

Economics

If hydrogen peroxide is not yet used in the chlor-alkali plant, specific equipment needs to be installed. The installation of peroxide dosing equipment requires lower investment costs than a separate scrubber [68, AkzoNobel 2007], [185, InfoMil 2011].

Driving force for implementation

The driving force for implementation of this technique is environmental legislation.

Example plants

- AkzoNobel in Delfzijl (Netherlands), chlorine capacity 121 kt/yr;
- AkzoNobel in Ibbenbüren (Germany), chlorine capacity 125 kt/yr;
- AkzoNobel in Rotterdam-Botlek (Netherlands), chlorine capacity 637 kt/yr.

Reference literature

[34, Solvay 2010], [68, AkzoNobel 2007], [185, InfoMil 2011], [191, Lassche 2011], [192, Euro Chlor 2011], [193, Jia et al. 2000], [194, Gordon and Tachiyashiki 1991]

4.3.5.3 Carbon tetrachloride-free chlorine purification and recovery

Description

This technique consists in preventing emissions of carbon tetrachloride to air by using carbon tetrachloride-free techniques for the elimination of nitrogen trichloride and for the recovery of chlorine from the tail gas of the liquefaction unit.

Technical description

In 2011, three chlor-alkali plants in the EU-27 were using carbon tetrachloride for the extraction of nitrogen trichloride (NCl_3) from chlorine and/or for the recovery of diluted chlorine from waste gas (Section 3.4.4.2.4) [61, DG CLIMA 2012]. Worldwide, carbon tetrachloride was reported to be used in 2006 by nine plants to manage nitrogen trichloride and by a further three to manage tail gas emissions [322, UNEP 2008].

Carbon tetrachloride is classified as toxic and has a high ozone depletion potential ($\text{ODP} = 1.1$) [76, Regulation EC/1272/2008 2008], [78, Regulation EC/1005/2009 2009]. Although its use is generally prohibited, an exemption is granted for its use as a process agent for the aforementioned applications in installations already existing on 1 September 1997 [78, Regulation EC/1005/2009 2009]. Plants that are allowed to use ozone-depleting substances as process agents are listed in Commission Decision 2010/372/EU. The confidential annex to this decision sets maximum quantities that may be used for make-up and emitted for each of the undertakings concerned [294, Decision 2010/372/EU 2010]. However, other alternatives which do not use CCl_4 are available and applicable to existing plants.

First of all, if chlorine can be used directly without liquefaction it may not be necessary to remove the NCl_3 . A preventative technique to avoid the accumulation of NCl_3 is to ensure low concentrations of ammonium (and other nitrogen-containing compounds which may lead to the formation of NCl_3) in the raw materials, for example by using vacuum salt without ferrocyanides (Section 4.3.2.3.5). Potential nitrogen sources are described in Section 2.6.11.4. Another technique is to purify the brine by removing ammonium ions (for example by the stripping of ammonia with air under alkaline conditions or by chlorination of ammonia to monochloramine or molecular nitrogen at a pH higher than 8.5) [35, Euro Chlor 2012], [36, Euro Chlor 2010], [201, Piersma 2001], [216, O'Brien et al. 2005, Section 9.1.11.2C].

Available techniques for NCl_3 destruction, not using CCl_4 , include [35, Euro Chlor 2012], [201, Piersma 2001]:

- elimination from gaseous chlorine by reaction with hydrochloric acid ($\text{NCl}_3 + 4 \text{HCl} \rightarrow \text{NH}_4\text{Cl} + 3 \text{Cl}_2$)
- destruction in gaseous chlorine ($2 \text{NCl}_3 \rightarrow \text{N}_2 + 3 \text{Cl}_2$) by using:
 - UV radiation (dry chlorine; wavelength range 360–479 nm);
 - thermal treatment at temperatures of 95–100 °C;
 - activated carbon filters (filters also remove other impurities);
- destruction in liquid chlorine ($2 \text{NCl}_3 \rightarrow \text{N}_2 + 3 \text{Cl}_2$) by thermal treatment at 60–70 °C.

Several methods are available for handling the residual gas (non-condensables such as CO_2 , O_2 , N_2 and H_2 saturated with chlorine) leaving the liquefaction unit. The most common is absorption in caustic soda to produce sodium hypochlorite (Section 4.3.5.1). The product, depending on the market, is often saleable. Recycling of the hypochlorite to the brine system or to other process streams on the site is also sometimes possible. If the hypochlorite cannot be used, it is destroyed using the techniques described in Section 4.3.6.3. Other methods include the manufacture of HCl , FeCl_3 or ethylene dichloride.

Achieved environmental benefits

The achieved environmental benefit of this technique is the prevention of carbon tetrachloride emissions.

Environmental performance and operational data

At the INEOS ChlorVinyls plant (formerly Hydro Polymers) in Stenungsund (Sweden), the use of CCl_4 for purification purposes was abandoned before 2000. Since then, the gaseous chlorine is sent directly to the VCM plant, where NCl_3 is decomposed at an elevated temperature. This method is a standard technique for plants with integrated VCM production [75, COM 2001].

At the AkzoNobel plants in Delfzijl and Rotterdam-Botlek (Netherlands), the use of carbon tetrachloride stopped during the first decade of the 21st century in parallel with the installation of new membrane cell units. In both plants, the intake of nitrogen compounds with the raw materials was reduced. Furthermore, the plants were designed so as to avoid NCl_3 accumulation above critical limits. Finally, the possibility to thermally destruct NCl_3 in liquid chlorine exists, but is rarely used [202, AkzoNobel 2010].

Cross-media effects

No cross-media effects occur when chlorine is directly used without liquefaction. Reducing the intake of nitrogen compounds with the raw materials (salt, water, ancillary materials) should lead to only minor cross-media effects, except where additional purification steps are necessary. However, some ancillary materials and energy are consumed if ammonium is removed from the brine or if nitrogen trichloride is destroyed after its formation. The stripping of ammonia requires additional treatment of the waste gases. The destruction of NCl_3 to nitrogen and chlorine is strongly exothermic and may require additional safety measures. When using radiation, a low hydrogen content in chlorine has to be ensured to avoid the risk of explosions [36, Euro Chlor 2010].

If there is no market for the bleach produced from the absorption of the tail gas, some energy and ancillary materials are required for its treatment (Section 4.3.6.3).

Technical considerations relevant to applicability

Generally, there are no technical restrictions to the applicability of this technique.

Economics

Depending on the plant design, some equipment may require replacement.

Driving force for implementation

The driving force for implementation of this technique is environmental legislation.

Example plants

- Carbon tetrachloride-free chlorine liquefaction and purification processes are applied in nearly all chlor-alkali plants in the EU-27 and EFTA countries;
- AkzoNobel in Delfzijl (Netherlands), chlorine capacity 121 kt/yr;
- AkzoNobel in Rotterdam-Botlek (Netherlands), chlorine capacity 637 kt/yr;
- INEOS ChlorVinyls (formerly Hydro Polymers) in Stenungsund (Sweden), chlorine capacity 120 kt/yr.

Reference literature

[35, Euro Chlor 2012], [36, Euro Chlor 2010], [61, DG CLIMA 2012], [75, COM 2001], [76, Regulation EC/1272/2008 2008], [78, Regulation EC/1005/2009 2009], [198, WMO 2006], [201, Piersma 2001], [202, AkzoNobel 2010], [216, O'Brien et al. 2005, Section 9.1.11.2C], [294, Decision 2010/372/EU 2010]

4.3.5.4 Use of refrigerants without ozone depletion potential and with low global warming potential

Description

This technique consists in using refrigerants with zero ozone depletion potential (ODP) and low global warming potential (GWP < 150) for chlorine liquefaction. Suitable refrigerants include ammonia, carbon dioxide, chlorine and water.

Technical description

The choice of refrigerant for chlorine liquefaction depends on the pressure. Hydrochlorofluorocarbons (HCFCs), hydrofluorocarbons (HFCs), chlorine and ammonia are frequently used if the temperatures are below -10 °C (Section 2.6.8). HCFCs have the disadvantage of depleting the ozone layer when released to the atmosphere. They also show considerable GWP. The use of HCFCs is generally prohibited, but reclaimed or recycled HCFCs may be used for the maintenance or servicing of existing refrigeration equipment until 31 December 2014 [78, Regulation EC/1005/2009 2009]. HFCs have the disadvantage of possessing a much higher GWP than alternative refrigerants such as ammonia, carbon dioxide, chlorine and water. Regulation EC/842/2006 contains provisions aiming at containing, preventing and thereby reducing emissions of HFCs. The regulation also covers preparations containing fluorinated greenhouse gases, except where the total GWP of the preparation is less than 150 [295, Regulation EC/842/2006 2006]. In 2012, the European Commission published a proposal for a new regulation on fluorinated greenhouse gases, including restrictions for some types of equipment containing HFCs with a GWP of 150 or more [341, COM 2012].

Table 4.26 summarises the advantages and disadvantages of refrigerants frequently used in chlor-alkali plants for chlorine liquefaction.

Table 4.26: Advantages and disadvantages of refrigerants frequently used in chlor-alkali plants for chlorine liquefaction

Refrigerant	Advantages	Disadvantages
Ammonia (R-717)	Excellent thermodynamic and thermophysical properties, inexpensive, ODP = 0, GWP = 0	Toxic, flammable, explosive if mixed with chlorine, two cooling circuits required
Carbon dioxide (R-744)	Non-toxic, non-flammable, inexpensive, ODP = 0, GWP = 1	Asphyxiant, low critical temperature
Chlorine	No cross-contamination	Larger amounts of chlorine in the production unit
HCFC-22 (R-22, chlorodifluoromethane)	Non-toxic, non-flammable	ODP = 0.055 ⁽¹⁾ , GWP = 1 810 ⁽²⁾ , to be replaced by 31 December 2014
HFC-134a (R-134A, 1,1,1,2-tetrafluoroethane)	Non-toxic, non-flammable, equipment can be reused when changing from HCFC-22	GWP = 1 300 ⁽³⁾
R-404A: • 44.0 wt % HFC-125 • 52.0 wt-% HFC-143a • 4.0 wt-% HFC-134a	Non-toxic, non-flammable, equipment can be reused when changing from HCFC-22	GWP = 3 784 ⁽³⁾
R-410A: • 50.0 wt-% HFC-32 • 50.0 wt-% HFC-125	Non-toxic, non-flammable, zeotropic mixture (but very small temperature glide)	GWP = 1 975 ⁽³⁾
R-422A: • 85.1 wt % HFC-125 • 11.5 wt-% HFC-134a • 3.4 wt % R-600a	Non-toxic, non-flammable, equipment can be reused when changing from HCFC-22	GWP = 3 043 ⁽³⁾
R-507A: • 50.0 wt-% HFC-125 • 50.0 wt-% HFC-143a	Non-toxic, non-flammable, azeotropic mixture, equipment can be reused when changing from HCFC-22	GWP = 3 850 ⁽³⁾
Water (R-718)	Non-toxic, non-flammable, inexpensive (no vapour-compression refrigeration cycle), ODP = 0	High boiling and freezing point, therefore higher pressures for liquefaction needed

⁽¹⁾ [78, Regulation EC/1005/2009 2009].
⁽²⁾ GWP refers to a time horizon of 100 years [198, WMO 2006].
⁽³⁾ Calculated from the weighted average of the individual components [295, Regulation EC/842/2006 2006]:
• HFC-32 (difluoromethane), GWP = 550 [295, Regulation EC/842/2006 2006];
• HFC-125 (pentafluoroethane), GWP = 3 400 [295, Regulation EC/842/2006 2006];
• HFC-134a (1,1,1,2-tetrafluoroethane), GWP = 1 300 [295, Regulation EC/842/2006 2006];
• HFC-143a (1,1,1-trifluoroethane), GWP = 4 300 [295, Regulation EC/842/2006 2006];
• R-600A (isobutane), GWP ~ 4 (indirect GWP referring to a time horizon of 100 years) [152, Linde 2010].
NB: GWP = global warming potential; ODP = ozone depletion potential.
Source: [57, CAK TWG 2012], [78, Regulation EC/1005/2009 2009], [152, Linde 2010], [198, WMO 2006], [200, UBA DE 2011], [270, Orica 2011], [295, Regulation EC/842/2006 2006], [296, Euro Chlor 2012]

Achieved environmental benefits

The achieved environmental benefits of this technique include:

- prevention of emissions of ozone-depleting substances;
- prevention of emissions of substances with high global warming potential.

Environmental performance and operational data

At the Dow plant in Stade (Germany), chlorine is used as the refrigerant [199, Bezirksregierung Lüneburg 1997].

At the Orica plants in Melbourne and Sydney (Australia), the chlorine gas is liquefied by carbon dioxide evaporating at -45 °C and the carbon dioxide is in turn recondensed by an ammonia

refrigeration unit operating at $-52.6\text{ }^{\circ}\text{C}$ saturated suction temperature and $40\text{ }^{\circ}\text{C}$ condensing temperature. Because ammonia and chlorine are so reactive, they are physically separated from each other in the plant and in the refrigeration system. The ammonia refrigeration system is designed to provide cooling to a carbon dioxide thermosiphon loop, which then provides cooling to the chlorine liquefaction process. The advantage of the thermosiphon system is that there are no moving parts or additional energy inputs. The brake horsepower of the refrigeration system ranges from 4.4 to 4.5 per tonne of refrigeration (equivalent to $\sim 3.3\text{ kW}$ per tonne of refrigeration). The liquefied chlorine is stored at $-41\text{ }^{\circ}\text{C}$ and atmospheric pressure [270, Orica 2011].

Cross-media effects

Additional raw materials and energy are consumed if an existing liquefaction unit is replaced. Some other cross-media effects are listed in Table 4.26.

Technical considerations relevant to applicability

Generally, there are no technical restrictions to the use of substances with an ODP = 0 and a GWP < 150 in new plants. For existing plants, the replacement of HCFCs/HFCs by other refrigerants usually requires a major rebuild of the liquefaction unit, which might be impeded by the limited space on the site, in particular during the transition phase (i.e. when the new liquefaction unit is built, while the old one is still in operation) [153, Spolchemie 2012].

Economics

For existing plants, a change of refrigerant from HCFCs/HFCs to chlorine, water, ammonia or carbon dioxide usually requires a major rebuild of the liquefaction unit. The costs for a plant with a chlorine capacity of approximately 60 kt/yr were very roughly estimated to be several hundred million CZK (CZK 400 million is equivalent to EUR 16 million; EUR/CZK = 24.87, currency conversion date May 2012) [153, Spolchemie 2012].

Driving force for implementation

The driving force for implementation of this technique is environmental legislation.

Example plants

- Dow in Stade (Germany), chlorine capacity 1585 kt/yr, use of chlorine as refrigerant [199, Bezirksregierung Lüneburg 1997];
- Orica in Melbourne (Australia), chlorine capacity 31 kt/yr, use of carbon dioxide and ammonia as refrigerants [238, Clews 2001];
- Orica in Sydney (Australia), chlorine capacity 31 kt/yr, use of carbon dioxide and ammonia as refrigerants [238, Clews 2001];
- SABIC in Bergen op Zoom (Netherlands), chlorine capacity 89 kt/yr, use of ammonia and carbon dioxide as refrigerants [57, CAK TWG 2012];
- Solvay in Torrelavega (Spain), chlorine capacity 63 kt/yr, use of ammonia and carbon dioxide as refrigerants [57, CAK TWG 2012];
- Vinnolit in Gendorf (Germany), chlorine capacity 180 kt/yr, use of water as refrigerant [57, CAK TWG 2012].

Reference literature

[57, CAK TWG 2012], [78, Regulation EC/1005/2009 2009], [152, Linde 2010], [153, Spolchemie 2012], [198, WMO 2006], [199, Bezirksregierung Lüneburg 1997], [200, UBA DE 2011], [238, Clews 2001], [270, Orica 2011], [295, Regulation EC/842/2006 2006]

4.3.6 Techniques to reduce emissions to water

4.3.6.1 Techniques to reduce emissions of sulphate

4.3.6.1.1 Overview

In addition to the technique described in the following Section 4.3.6.2.2, the recycling or reuse of spent sulphuric acid from chlorine drying (Section 4.3.7) and the use of non-sulphur-containing reducing agents to reduce emissions of free chlorine (Sections 4.3.6.3.3 to 4.3.6.3.6) also reduce sulphate emissions.

4.3.6.1.2 Crystallisation of sodium sulphate

Description

This technique consists in crystallising and recovering sodium sulphate from the brine purification in the case of membrane cell plants and from the caustic soda evaporators in the case of diaphragm cell plants.

Technical description

A general description of crystallisation can be found in the CWW BREF [124, EC 2003].

The sulphate concentration in the brine depends on the quality of the salt used and needs to be carefully controlled to prevent damage to anodes and membranes (Section 3.4.3.3.2 and Table 2.4). This is usually achieved by purging a part of the brine (sometimes using nanofiltration to produce a concentrated stream, see Section 4.3.6.2.2) or by precipitation as barium sulphate. The latter technique requires the use of expensive barium salts, which additionally are detrimental to membranes if not completely removed from the brine (Section 4.3.6.2.2).

An alternative to these techniques is to crystallise sodium sulphate, which is a saleable product after purification. Sodium sulphate can crystallise in its anhydrous form Na_2SO_4 , as decahydrate $\text{Na}_2\text{SO}_4 \cdot 10 \text{H}_2\text{O}$, as a mixed salt with NaCl, or as a mixed salt with NaCl and NaOH, depending on the temperature and composition of the solution [1, Ullmann's 2006], [205, Ullmann's 2000].

Crystallisation of sodium sulphate can in principle be achieved by cooling the brine or by evaporating the excess water. However, the sulphate concentrations in depleted or resaturated brine are far below the solubility limit of sodium sulphate, so a large amount of water would need to be evaporated before crystallisation starts. Therefore, crystallisation is only an option if solution-mined brine is used as a raw material and the depleted brine is reconcentrated by evaporation, or if sodium sulphate can be crystallised from a concentrated side-stream, such as the concentrate of a nanofiltration unit (Section 4.3.6.2.2) [127, Eckert 2010], [293, Euro Chlor 2012].

In the diaphragm cell technique, pure sodium sulphate can be recovered from the cell liquor if the caustic solution is concentrated in an evaporator [1, Ullmann's 2006].

Achieved environmental benefits

The achieved environmental benefits of this technique include:

- reduction of sulphate emissions;
- reduction of consumption of raw materials and energy (compared to other processes to produce sodium sulphate).

Environmental performance and operational data

At the AkzoNobel plant in Bitterfeld (Germany), solution-mined brine is used as a raw material for the membrane cells. The depleted brine is reconcentrated in a four-stage evaporator. Sodium chloride crystallises in the second and third stages and is reused for brine resaturation, while sodium sulphate crystallises in the fourth stage and is subsequently purified and sold [69, Regierungspräsidium Dessau 1999]. The plant reports an annual average sulphate emission load of 0.72 kg/t annual chlorine capacity [57, CAK TWG 2012].

Cross-media effects

Some raw materials and energy are consumed for the crystallisation and purification of sodium sulphate. Cooling of the brine stream to crystallise sodium sulphate, with subsequent reheating of the brine, is energy-intensive. Brine resaturation with evaporators also consumes considerable amounts of energy.

Technical considerations relevant to applicability

No information provided.

Economics

No information provided.

Driving force for implementation

The driving forces for implementation of this technique include:

- necessity to remove sulphate from the brine to protect the equipment;
- generation of a saleable by-product.

Example plants

- AkzoNobel in Bitterfeld (Germany), chlorine capacity 99 kt/yr

Reference literature

[1, Ullmann's 2006], [57, CAK TWG 2012], [69, Regierungspräsidium Dessau 1999], [127, Eckert 2010], [205, Ullmann's 2000]

4.3.6.2 Techniques to reduce emissions of chloride

4.3.6.2.1 Overview

In addition to the technique described in the following Section 4.3.6.2.2, several of the techniques to reduce the consumption of salt (Section 4.3.2.1.3), to reduce the consumption of water (Section 4.3.2.2) and to reduce emissions of chlorate (Section 4.3.6.4) also reduce chloride emissions.

4.3.6.2.2 Nanofiltration

Description

In chlor-alkali plants with brine recirculation, sulphate builds up and needs to be removed (Table 2.4 and Section 3.4.3.3.2). This is most commonly achieved by purging a part of the brine, or to a lesser extent by precipitation of barium sulphate. As an alternative, nanofiltration can be used to concentrate sulphate in the brine purge, whereby either 1) the waste water volume and the chloride emission loads are reduced, or 2) the use of barium salts is avoided. Nanofiltration is a specific type of membrane filtration with membrane pore sizes of approximately 1 nm.

Technical description

A general description of nanofiltration can be found in the CWW BREF [124, EC 2003].

Before entering the nanofiltration unit, the depleted brine is pretreated by pH adjustment, cooling, removal of residual chlorine, and filtration, in order to guarantee the long-term performance of the membranes. The pretreated brine is then fed at high pressure to the filtration unit, which is operated in cross-flow mode and usually consists of several stages. The nanofiltration membrane has charged groups which selectively reject multivalent anions, such as sulphate. On the other hand, monovalent ionic species, such as chloride and chlorate from the feed brine, pass through the membrane into the permeate, which is low in sulphate. The permeate from each stage is collected and recirculated to the brine resaturation unit. As water and NaCl pass through the membrane, the portion of the brine which remains becomes enriched in sulphate, reaching a final concentration after several stages of more than 100 g/l Na₂SO₄. Since the sulphate concentration in the final concentrate is high, a very low volume is purged from the brine, resulting in low chloride emissions [125, Aker Chemetics 2010]. The sulphate from the concentrate may be crystallised as solid Na₂SO₄. [127, Eckert 2010].

Achieved environmental benefits

The achieved environmental benefits of this technique include:

- reduction of chloride emissions, if the brine purge rate is determined by the sulphate concentration;
- reduction of the consumption of salt, water and ancillary materials, if the brine purge rate is determined by the sulphate concentration;
- avoidance of handling of toxic barium compounds;
- prevention of barium sulphate waste generation.

Environmental performance and operational data

According to a manufacturer, nanofiltration units are generally designed to meet a Na₂SO₄ concentration of > 100 mg/l in the final concentrate [127, Eckert 2010].

Compared to the brine purge method, the volumetric flow of the purge stream can be reduced by up to 90 % if the purge rate is determined by the sulphate concentration, thereby reducing emission loads of chloride from this process step by the same percentage. The overall salt consumption may be reduced by 20 % or more, depending on the sulphate content of the raw material. The consumption of demineralised water is also reduced. The reduced salt consumption leads to reduced levels of impurities such as calcium and magnesium in the brine, which reduces the consumption of ancillary materials during primary brine treatment.

Compared to the barium precipitation method, nanofiltration eliminates the need for handling toxic barium salts and for barium sulphate sludge disposal. In addition, residual barium impurities in the brine which are not precipitated as sulphate may damage the membranes in membrane cells, leading to reduced lifetimes and increased energy consumption (Table 2.4). [125, Aker Chemetics 2010]. In this respect, one membrane supplier reported that barium (plus iodine) is the brine impurity with the worst impact on cell voltage [72, Nishio 2011]. However, membrane specifications concerning barium can also be met by a proper design and operation of the sulphate precipitation step and of the secondary brine treatment (ion exchange) [216, O'Brien et al. 2005, Sections 7.5.5.1 and 7.5.7.2B].

The first full-scale nanofiltration system was put into operation in 1997. Since then, more than 70 systems have been installed worldwide. The lifetime of the nanofiltration membranes usually exceeds 18 months. The required power for the high-pressure pump(s) ranges from 20 to 150 kW [127, Eckert 2010].

At the Solvic chlor-alkali plant in Jemeppe (Belgium), a nanofiltration unit with a sulphate removal capacity of 190 kg/h was put into operation in 2004. Sulphate is concentrated in three steps up to approximately 70 g/l, at approximately 40 bar. The energy consumption is

approximately 5 kWh/t chlorine produced. The lifetime of the expensive membranes is one to two years. Due to the purity of the incoming brine, no backwashing is necessary. Rinsing with water is only employed in the case of plant shutdowns [34, Solvay 2010].

Cross-media effects

Some raw materials and energy are consumed for the production of the nanofiltration units. During operation, electricity is consumed for the high-pressure pumps. Compared to sulphate removal via precipitation with barium salts, higher emissions of sulphate to water occur.

Technical considerations relevant to applicability

The technique is applicable to new and existing membrane cell plants with brine recirculation. Diaphragm cell plants do not recirculate brine and sulphate is usually removed during caustic concentration.

If the brine purge rate is determined by the concentration of impurities other than sulphate (e.g. chlorate, silica or iodine), nanofiltration does not reduce this rate.

Economics

The investment costs depend on plant-specific factors such as annual chlorine capacity and the sulphate content of the salt. Operational costs are mostly related to electricity consumption for the pumps and to the replacement of the membranes [127, Eckert 2010]. More detailed figures are not available.

The use of nanofiltration leads to considerable savings, resulting from either 1) the reduced consumption of salt, demineralised water and ancillary materials, or 2) the elimination of the need to purchase expensive barium salts and to dispose of barium sulphate sludges. Examples for cost savings, as provided by an equipment supplier, are summarised in Table 4.27.

Table 4.27: Examples of operational cost savings for plants replacing brine purge or barium sulphate precipitation by nanofiltration

Cost savings for plants with brine purge							
Membrane cell plant capacity		Sulphate content of salt	Reduction of salt consumption	Cost savings due to reduced salt consumption ⁽¹⁾		Cost savings due to reduced water and ancillary materials consumption	
t NaOH/d	t Cl ₂ /yr ⁽²⁾	wt-%	%	USD/yr ⁽²⁾	EUR/yr ⁽³⁾	USD/yr ⁽²⁾	EUR/yr ⁽³⁾
1 000	324 000	0.25	8	1 300 000	1 700 000	200 000	270 000
500	162 000	0.5	17	1 500 000	2 000 000	200 000	270 000
200	67 700	0.5	17	600 000	800 000	90 000	120 000
Cost savings for plants with barium sulphate precipitation							
Membrane cell plant capacity		Sulphate content of salt	BaCl ₂ consumption	Operating costs for BaSO ₄ precipitation		Cost savings due to improved energy efficiency ⁽⁴⁾	
t NaOH/d	t Cl ₂ /yr ⁽⁵⁾	wt-%	t/d	USD/yr ⁽²⁾	EUR/yr ⁽³⁾	USD/yr ⁽²⁾	EUR/yr ⁽³⁾
1 000	324 000	0.25	8	1 500 000	2 000 000	300 000	400 000
500	162 000	0.5	8	1 500 000	2 000 000	150 000	200 000
200	67 700	0.5	3.5	625 000	830 000	60 000	80 000

⁽¹⁾ Assuming salt costs of USD 30/t (equivalent to EUR 40/t).
⁽²⁾ Original currency.
⁽³⁾ Currency conversion date May 2010 (EUR/USD = 1.325 6).
⁽⁴⁾ No energy savings can be expected in comparison to a properly designed and operated barium sulphate precipitation unit.
⁽⁵⁾ Assuming a production of 1.128 t NaOH (100 %)/t Cl₂ produced.
Source: [125, Aker Chemetics 2010]

As a result of the savings, typical payback times are in the range of one to three years [125, Aker Chemetics 2010]. In the case of plants operating with salt with a low sulphate content (< 0.1 wt-%), nanofiltration is usually not economical [127, Eckert 2010], [333, Euro Chlor 2012].

At the Solvic chlor-alkali plant in Jemeppe (Belgium), a payback time of less than two years was reported, as the plant reduced its own production of vacuum salt [34, Solvay 2010].

Driving force for implementation

The driving forces for implementation of this technique include:

- reduction of operating costs, due to the reduced consumption of salt, water and ancillary materials;
- reduction of operating costs, due to reduced amount of waste for disposal.

Example plants

- More than 70 plants worldwide and more than 10 plants in Europe [126, Lashkari and Drackett 2011];
- Solvic in Jemeppe (Belgium), chlorine capacity 174 kt/yr.

Reference literature

[34, Solvay 2010], [72, Nishio 2011], [124, EC 2003], [125, Aker Chemetics 2010], [126, Lashkari and Drackett 2011], [127, Eckert 2010], [216, O'Brien et al. 2005], [333, Euro Chlor 2012]

4.3.6.3 Techniques to reduce emissions of free chlorine

4.3.6.3.1 Overview

The chlor-alkali industry potentially discharges waste water containing free chlorine. The analytical method used determines which oxidising species are comprised in the analytical result (Section 4.3.3.5).

All water streams that have been in contact with chlorine and/or bromine may contain free chlorine. In the chlor-alkali plants these streams are:

- the purge from the brine circuit;
- the condensate from the chlorine gas cooling;
- the bleach (sodium hypochlorite) produced by the chlorine absorption unit.

The free chlorine can be destroyed by [192, Euro Chlor 2011]:

- chemical reduction (Section 4.3.6.3.3);
- catalytic decomposition (Section 4.3.6.3.4);
- thermal decomposition (Section 4.3.6.3.5);
- acidic decomposition (Section 4.3.6.3.6).

In some cases, combinations of techniques are used, such as catalytic fixed-bed reduction with chemical reduction [207, Stitt et al. 2001], [208, Johnson Matthey 2009].

4.3.6.3.2 Common issues for all techniques to reduce emissions of free chlorine

In order to avoid repetitions in the following sections, common issues for all techniques to reduce emissions of free chlorine are described here.

Technical Description

The treatment of waste water streams containing free chlorine is usually carried out as close as possible to the source, to prevent stripping and/or the formation of halogenated organic compounds (Section 3.4.3.3.4).

Achieved environmental benefits

The achieved environmental benefit of the techniques described in Sections 4.3.6.3.3 to 4.3.6.3.6 is a reduction of emissions of free chlorine.

Environmental performance and operational data

Current emission levels of free chlorine in waste water at the outlet of the electrolysis unit are presented in Section 3.4.3.3.4.

Cross-media effects

Some equipment, ancillary materials and energy are required for the reduction of emissions. All reactions leading to the destruction of free chlorine are exothermic and require careful process control. Cross-media effects specific to the technique used are described in Sections 4.3.6.3.3 to 4.3.6.3.6.

Technical considerations relevant to applicability

Generally, there are no technical restrictions to the applicability of techniques to reduce emissions of free chlorine. If this is not the case for a specific technique, this is mentioned in Sections 4.3.6.3.3 to 4.3.6.3.6.

Driving force for implementation

The driving force for implementation of the techniques described in Sections 4.3.6.3.3 to 4.3.6.3.6 is environmental legislation.

Example plants

Almost all existing plants in the EU-27 and EFTA countries use techniques to reduce the concentration of free chlorine at the outlet of the chlor-alkali unit.

4.3.6.3.3 Chemical reduction

Description

This technique consists in destroying free chlorine by reaction with reducing agents, such as sulphite and hydrogen peroxide, in stirred tanks.

Technical Description

A general description of chemical reduction can be found in the CWW BREF [124, EC 2003].

Chemical reducing agents such as sulphur dioxide (SO₂), sodium sulphide (Na₂S), sodium sulphite (Na₂SO₃), sodium thiosulphate (Na₂S₂O₃) or hydrogen peroxide (H₂O₂) are used to destroy the free chlorine. The chlorine or hypochlorite is reduced to chloride (Cl⁻). The choice of the chemical reducing agent is influenced by cost, availability, and ease of handling. Depending on the reducing agent, the following reactions take place [2, Le Chlore 2002], [207, Stitt et al. 2001]:

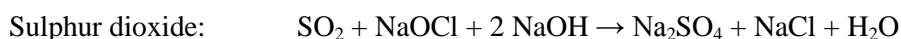

Sodium sulphite: $\text{Na}_2\text{SO}_3 + \text{NaOCl} \rightarrow \text{Na}_2\text{SO}_4 + \text{NaCl}$

Sodium thiosulphate: $2 \text{Na}_2\text{S}_2\text{O}_3 + \text{NaOCl} + \text{H}_2\text{O} \rightarrow \text{Na}_2\text{S}_4\text{O}_6 + \text{NaCl} + 2 \text{NaOH}$

Hydrogen peroxide: $\text{H}_2\text{O}_2 + \text{NaOCl} \rightarrow \text{O}_2 + \text{NaCl} + \text{H}_2\text{O}$

Chemical reducing agents have the advantage of also reacting with chloramines and bromamines.

Sufficient residence time and an excess of reducing agents are required to ensure the complete destruction of free chlorine [17, Dutch Ministry 1998]. In order to control the heat of the exothermic reaction, diluted solutions are used to limit the temperature to about 50 °C. For example, to reduce 1 kg of chlorine absorbed, 4.45 kg of reactive agent $\text{Na}_2\text{S}_2\text{O}_3$ or 89 kg of diluted 5 wt-% solution are required [2, Le Chlore 2002].

Environmental performance and operational data

The efficiency of the reaction depends on the amount and type of chemical used. In general, chemical reduction can reduce the concentration of free chlorine to levels < 0.5 mg/l [3, Euro Chlor 2011].

Current emission levels of free chlorine to water are presented in Table 3.16. The lowest maximum concentration reported was < 0.03 mg/l, and the lowest annual average concentration 0.02 mg/l. Taking into account data reported as ranges and annual averages, it can be estimated that emissions of free chlorine from the plants covered by the survey were in 29 % of the cases ≤ 0.1 mg/l during normal operation, in 42 % of the cases ≤ 0.2 mg/l, and in 52 % of the cases ≤ 0.5 mg/l [57, CAK TWG 2012]. Example data from well-performing plants are shown in Table 4.28.

Table 4.28: Example data from chlor-alkali plants with low emissions of free chlorine to water in the EU-27 in 2008 to 2011

Plant, location	Concentrations in mg/l (¹)	Reference year	Reference conditions
AkzoNobel in Bitterfeld (Germany)	< 0.2	2010	Periodic measurements, grab samples
CABB in Gersthofen (Germany)	< 0.1	2009–2011	Measurement with DPD and titration
Cimcomplex in Borzești (Romania)	< dl–0.05	2009	Measurement three times a day
Donau Chemie in Brückl (Austria)	< 0.03	2008	dl = 0.03 mg/l
Solvin in Antwerp-Lillo (Belgium)	< 0.1	2008	Daily measurement
Oltchim in Râmnicu Vâlcea (Romania)	< 0.02–0.047	2011	Measurement three times a day, dl = 0.02 mg/l, data refer to membrane cell unit
Syndial in Assemini (Italy)	0.1–0.2	2009	NI
TKI Hrastnik in Hrastnik (Slovenia)	0.03–0.05	2009	NI

(¹) Data refer to the outlet of the chlor-alkali plant.
 NB: dl = detection limit; NI = no information provided.
 Source: [57, CAK TWG 2012]

Membrane cell plants and other plants using secondary brine purification have to ensure that the depleted brine is completely dechlorinated, to prevent damages to the ion-exchange resins

(Section 2.5.4). If necessary, the brine is purged after the (total) dechlorination unit of the brine circuit.

Cross-media effects

Many of the reducing agents require careful handling. Sulphur dioxide is classified as toxic. When using sodium sulphide, the pH of the solution requires careful monitoring to avoid the formation of very toxic hydrogen sulphide. Hydrogen peroxide can be oxidising and irritant/corrosive, depending on the concentration [76, Regulation EC/1272/2008 2008].

Chemical reduction leads to the formation of chloride and, depending on the reducing agent, to the formation of oxy sulphur compounds (for example SO_4^{2-}). The use of sodium sulphide leads to the formation of elemental sulphur in the form of very fine particles. The amount of products formed depends on the amount of free chlorine to be reduced.

Any residual reducing agent in the effluent due to an overstoichiometric dosage increases the chemical oxygen demand (COD) of the waste water [17, Dutch Ministry 1998].

Economics

The cost of traditional chemical destruction of free chlorine is mainly related to the cost of chemicals. When the amount of free chlorine to be destroyed is low, chemical destruction is usually the least expensive option.

Whenever large amounts of free chlorine have to be destroyed (for example, in bleach destruction), catalytic or thermal destruction may be more economical [17, Dutch Ministry 1998].

Some economic data for chemical reduction with hydrogen peroxide are shown in Section 4.3.6.3.4.

Example plants

Many plants use classic chemical reduction to remove free chlorine from the waste water streams.

Reference literature

[1, Ullmann's 2006], [2, Le Chlore 2002], [3, Euro Chlor 2011], [17, Dutch Ministry 1998], [57, CAK TWG 2012], [76, Regulation EC/1272/2008 2008], [124, EC 2003], [207, Stitt et al. 2001]

4.3.6.3.4 Catalytic decomposition

Description

This technique consists in converting free chlorine to chloride and oxygen by using nickel-, iron- or cobalt-based catalysts. Catalytic decomposition can be carried out in fixed-bed reactors or with a catalyst slurry.

Technical description

The catalytic decomposition occurs according to the following overall reaction:

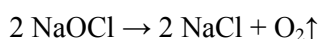

This decomposition reaction generally occurs in hypochlorite solutions, albeit too slowly to remove free chlorine in technical systems. The reaction is accelerated by metal catalysts, lower pH values and higher temperatures (Section 2.6.12.2). Depending on the conditions, hypochlorite may instead decompose to chloride and chlorate (Section 4.3.6.3.5).

Some systems operate with a catalyst slurry, which uses solutions of nickel, iron or cobalt compounds added to the waste water in stirred or agitated tanks [208, Johnson Matthey 2009]. Metal concentrations are typically 20 mg/l [2, Le Chlore 2002]. The high pH value of the solution causes the metal ions to precipitate as their hydroxides, which are then removed and regenerated. Alternatively, a fine dispersion of an insoluble metal compound can be used, which removes the need for the catalyst regeneration stage. In both cases, the catalyst must be allowed to settle before the supernatant water can be discharged, to avoid emissions of heavy metals. The reaction time combined with the settling of the catalyst takes several days [208, Johnson Matthey 2009]. The catalyst activity decreases from batch to batch, although it is unclear whether this is due to deactivation of the catalyst or loss of metal [75, COM 2001].

Other systems operate with the catalyst on a fixed-bed reactor (Figure 4.8). The catalyst used is a nickel oxide promoted with iron on an alumina support. The design of the reactor is modular. The gravity-fed hypochlorite solution flows countercurrently with respect to the evolving oxygen [206, Denye et al. 1995], [207, Stitt et al. 2001], [208, Johnson Matthey 2009].

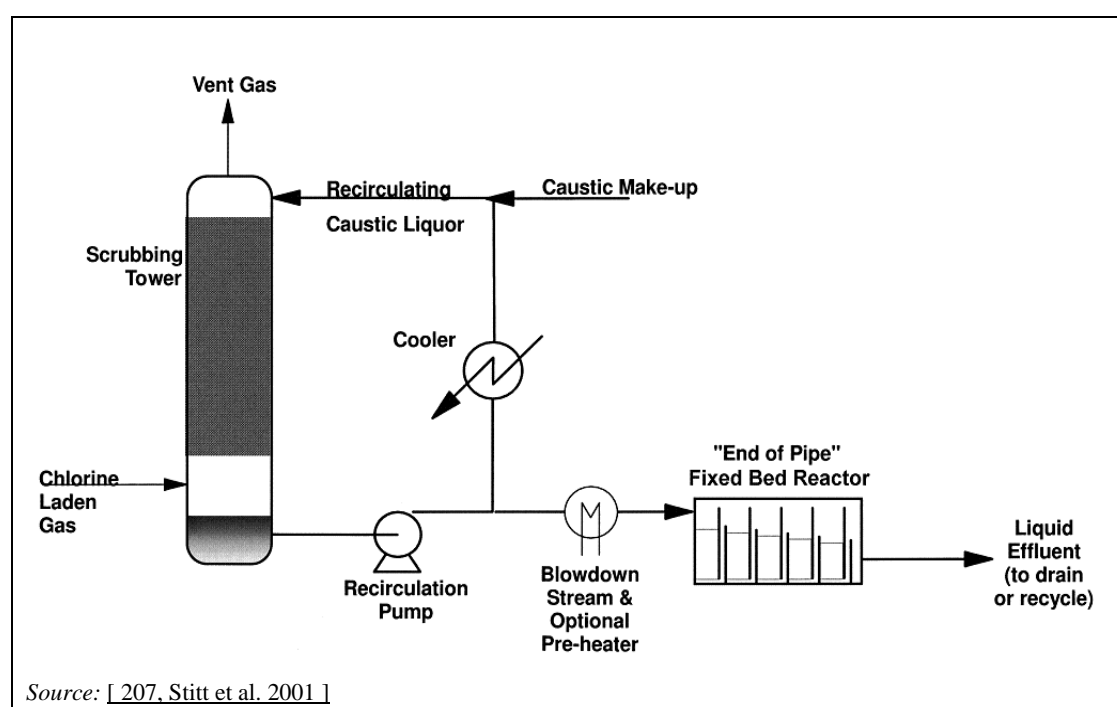

Figure 4.8: Flow diagram of a catalytic decomposition fixed-bed reactor process installed on the blowdown stream of a chlorine absorption unit

Catalytic fixed-bed decomposition is often used as a single end-of-pipe technique (Figure 4.8), but it can also be combined with chemical reduction. In this case, the outflow of the fixed-bed reactor is further treated with reducing agents. This technique is typically used for retrofitting plants which already use chemical reduction. Another possibility is to integrate the catalytic fixed-bed decomposition in the liquid recirculation loop of the chlorine absorption unit. The advantage of this process option is improved safety, due to a reduction of the recirculating hypochlorite [207, Stitt et al. 2001], [208, Johnson Matthey 2009].

In some cases, it is possible to recycle the effluent from the reactor back to the brine system. It is then necessary to control the concentration of chlorate and other impurities, in particular for the membrane cell technique. Chlorate may be formed in the chlorine absorption unit, depending on the hypochlorite ion concentration in the caustic scrubber recirculation liquor and the temperature in the scrubber itself [75, COM 2001].

Environmental performance and operational data

With a catalytic fixed-bed reactor, a hypochlorite solution of up to 150 g/kg can be treated in a single pass to free chlorine levels of less than 1 mg/kg in the pH range of 9–14 at ambient pressure and temperatures of 10–60 °C. The outlet concentration essentially depends on the number of installed catalytic beds. Since the reactor has a fixed bed configuration, no emissions of metals occur, contrary to classic catalytic decomposition. The lifetime of the catalyst is reported to be several years. This technique also reduces the levels of hypobromite, but not of chlorate or bromate. Moreover, the produced oxygen (i.e. the intermediate atomic oxygen on the catalyst surface) may react with organic compounds, thereby reducing the chemical oxygen demand (COD) [75, COM 2001], [206, Denye et al. 1995], [208, Johnson Matthey 2009].

Cross-media effects

A potential emission of heavy metals occurs in systems using a catalyst slurry. In systems with a fixed bed configuration, no emissions of heavy metals occur, as the catalyst is fixed in the bed. In both cases, the spent catalysts can usually be recycled. Otherwise, they become hazardous waste [206, Denye et al. 1995], [208, Johnson Matthey 2009].

Economics

The costs of a catalytic decomposition fixed-bed system will mainly depend on the quantity of free chlorine to be treated. Investment costs for a new decomposition unit were reported to be in the same order of magnitude as for a new chemical reduction unit. Operating costs are mostly linked to the catalyst, but also include electricity for pumps and steam for preheating, if necessary. A cost example is shown in Table 4.29 [208, Johnson Matthey 2009]. The flowrates and hypochlorite concentrations before treatment are typical for a plant with a chlorine capacity of approximately 100 kt/yr. The hypochlorite concentration after treatment is too high for discharges of the waste water to the environment or a sewerage system. The waste water therefore requires further treatment, if not recycled back to the brine system.

Table 4.29: Typical operating costs for partial hypochlorite destruction using catalytic fixed-bed decomposition or chemical reduction

Hypochlorite concentration		Flowrate	Catalytic fixed-bed decomposition		Chemical reduction	
Before treatment	After treatment		Typical costs for catalyst		Typical costs for H ₂ O ₂	
g/kg		m ³ /h	GBP/yr ⁽¹⁾	EUR/yr ⁽²⁾	GBP/yr ⁽¹⁾	EUR/yr ⁽²⁾
100	1	5	80–90	89–100	850–950	950–1 060
50	1	10	90–100	100–111	800–900	890–1 000

⁽¹⁾ Original currency.
⁽²⁾ Currency conversion date May 2009 (EUR/GBP = 0.898 75).
Source: [208, Johnson Matthey 2009]

Example plants

Fixed-bed catalytic decomposition has been installed in seven chlor-alkali plants worldwide since 1993 [258, Johnson Matthey 2011]:

- Shin-Etsu Chemicals in Naoetsu (Japan), chlorine capacity 45 kt/yr, catalytic decomposition put into operation in 1993;
- Sasol (formerly Polifin) in Sasolburg (South Africa), chlorine capacity 145 kt/yr, catalytic decomposition put into operation in 1994;
- Mitsui Toatsu in Nagoya (Japan), catalytic decomposition put into operation in 1996;
- Solvic in Jemeppe (Belgium), chlorine capacity 174 kt/yr, catalytic decomposition put into operation in 1997;
- Hanwha Chemical in Yeosu (South Korea), chlorine capacity 664 kt/yr, catalytic decomposition put into operation in 2005;

- Tsurumi Soda in Yokohama (Japan), catalytic decomposition put into operation in 2008;
- Shintech in Plaquemine, Louisiana (United States), chlorine capacity 418 kt/yr, catalytic decomposition put into operation in 2008 and 2010 (two units).

Besides the above-mentioned chlor-alkali plants, the catalytic fixed-bed decomposition process has been installed at approximately 30 other industrial sites where there is a need for bleach destruction [258, Johnson Matthey 2011].

Reference literature

[2, Le Chlore 2002], [17, Dutch Ministry 1998], [75, COM 2001], [206, Denye et al. 1995], [207, Stitt et al. 2001], [208, Johnson Matthey 2009], [258, Johnson Matthey 2011].

4.3.6.3.5 Thermal decomposition

Description

This technique consists in converting hypochlorite to chloride and chlorate by thermal decomposition at approximately 70 °C. The resulting effluent requires further treatment to reduce emissions of chlorate and bromate (Section 4.3.6.4).

Technical description

Decomposition of free chlorine (especially hypochlorite (OCl⁻)) can be achieved by acidifying the waste water to pH 6–7 and heating to approximately 70 °C. By this means, hypochlorite reacts to form chlorate (ClO₃⁻) and hydrochloric acid (HCl), according to the overall reaction [17, Dutch Ministry 1998]:

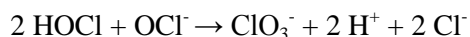

Environmental performance and operational data

The destruction efficiency of hypochlorite in the AkzoNobel plant in Delfzijl (Netherlands) was 95 %. Residual concentrations in the effluent were nevertheless high and most samples contained free chlorine in the range of 500–2 000 mg/l [17, Dutch Ministry 1998].

Cross-media effects

Thermal decomposition produces chlorate and hydrochloric acid. Depending on the amount of bromine compounds in the treated water, bromate may also be formed.

Economics

Whenever large amounts of free chlorine have to be destroyed (for example, in bleach destruction), thermal destruction may be more economical than chemical reduction [17, Dutch Ministry 1998].

Example plants

Thermal decomposition of free chlorine was used until 1999 at the AkzoNobel plant in Delfzijl (Netherlands), which at that time was a diaphragm cell plant with a chlorine capacity of 130 kt/yr. The technique was abandoned because regular discharges from the hypochlorite destruction unit were prohibited. The plant then started to recycle hypochlorite back to the brine system (Section 4.3.6.3.6) [210, Beekman 2001].

Reference literature

[17, Dutch Ministry 1998], [210, Beekman 2001]

4.3.6.3.6 Acidic decomposition

Description

This technique consists in decomposing hypochlorite by acidification, with a subsequent release and recovery of chlorine. Acidic decomposition can be carried out in a separate reactor or by recycling of the waste water to the brine system.

Technical description

If the quantities are low, the hypochlorite produced can be recycled to the brine at a low pH level (Section 4.3.2.2.3). The following reaction takes place:



In diaphragm cell plants, the recycling of hypochlorite has the additional advantage that any chlorate or bromate which may be contained therein (e.g. as a result of side reactions in the absorption unit, see Section 2.6.12.2) migrates through the diaphragm to the catholyte compartment of the cell, where it may be reduced with nascent hydrogen at the cathode according to the following overall reaction [210, Beekman 2001]:

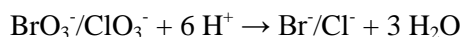

Environmental performance and operational data

In 1999, the AkzoNobel plant in Delfzijl (Netherlands) started to recycle hypochlorite from the chlorine absorption unit back to the brine feed. At that time, the plant was a diaphragm cell plant and the chlorine absorption unit was fed with the caustic liquor from the diaphragm cells. The hypochlorite produced therefore had a lower concentration of free chlorine and a higher concentration of sodium chloride compared to the more typical 18–22 wt-% sodium hydroxide scrubbing solution. All hypochlorite produced was then recycled, whereby emissions of chlorate or bromate from the chlorine absorption or hypochlorite destruction unit completely ceased. At the cathode, bromate was completely reduced to bromide, while chlorate was only partially reduced. This led to slightly increased levels of bromide and chlorate in the cell liquor, which was, however, offset by a slightly higher chlorine production (0.1 %) [210, Beekman 2001].

Cross-media effects

This technique leads to additional acid consumption.

Technical considerations to applicability

The degree of recycling of waste water to the brine circuit is restricted by the water balance of the plant. Impurities contained in the recycled hypochlorite can affect the electrolysis process and the quality of the products.

Economics

At the AkzoNobel plant in Delfzijl (Netherlands), acidic decomposition proved to be the most economic solution, compared to chemical and catalytic reduction. The costs for additional acid amounted to approximately NLG 100 000, corresponding to approximately EUR 45 000 [210, Beekman 2001].

Example plants

AkzoNobel in Delfzijl (Netherlands) has used acidic decomposition since 1999. At that time, the plant was based on the diaphragm cell technique and had a chlorine capacity of 130 kt/yr.

Reference literature

[17, Dutch Ministry 1998], [210, Beekman 2001]

4.3.6.3.7 Use of waste water streams containing free chlorine in other production units

Description

This technique consists in recycling waste water streams containing free chlorine to other production units. There are two reported uses of free chlorine in this regard: treatment of cooling water and treatment of ammonia/ammonium-containing waste waters.

Technical description

Free chlorine is frequently used as a biocide for the cooling water to reduce or prevent fouling [109, European Commission 2001]. By using waste water streams containing free chlorine from the chlor-alkali plant, the consumption of virgin reagents can be reduced.

At the Solvay plant in Póvoa de Santa Iria (Portugal), a residual level of free chlorine of 10 mg/l in the waste water from the chlor-alkali plant is maintained when it is reused to treat ammonia/ammonium-containing waste water from the sodium carbonate plant [110, Euro Chlor 2013]. The removal of ammonia/ammonium via chlorination is described in Section 4.3.5.3.

Achieved environmental benefits

The achieved environmental benefits of this technique include:

- reduction of emissions of free chlorine;
- overall reduction of raw material and energy consumption;
- overall reduction of chloride emissions due to reduced waste water volumes.

Environmental performance and operational data

No information provided.

Cross-media effects

There are no additional cross-media effects for a site that can make use of waste water of this quality.

Technical considerations relevant to applicability

The use of this technique is restricted to sites which can make use of the waste water streams of this quality in other production units.

Economics

Savings result from the reduced consumption of raw materials and energy.

Driving force for implementation

The driving force for implementation of this technique is a reduction of operating costs, due to the reduced consumption of raw materials and energy.

Example plants

- Solvay in Póvoa de Santa Iria (Portugal), chlorine capacity 26 kt/yr.

Reference literature

[109, European Commission 2001], [110, Euro Chlor 2013]

4.3.6.4 Techniques to reduce emissions of chlorate

4.3.6.4.1 Overview

Chlorate is formed in the electrolysis cell, either via anodic oxidation of hypochlorous acid or via disproportionation of hypochlorous acid (Section 2.1). Chlorate may also be formed in the chlorine absorption unit (Section 2.6.12.2) or during the thermal treatment of waste water containing free chlorine (Section 4.3.6.3.5). Bromate may be formed by the same mechanisms, depending on the level of bromide impurities in the salt.

Chlorate and bromate build up during brine recirculation but are unwanted compounds in the electrolysis process because they may damage equipment and reduce the caustic soda quality (Section 3.4.3.3.5). They leave the brine system via the brine purge. This and other waste water streams containing free chlorine are usually treated prior to discharge into the environment or a sewer system. However, techniques that reduce the levels of free chlorine do not reduce the levels of chlorate or bromate (Section 4.3.6.3). Techniques to reduce emissions of chlorate and bromate include [49, Euro Chlor 2010]:

- high-performance membranes (Section 4.3.2.3.2);
- high-performance coatings (Section 4.3.2.3.3);
- high-purity brine (Section 4.3.2.3.4);
- brine acidification (Section 4.3.6.4.2);
- acidic chlorate reduction (Section 4.3.6.4.3);
- catalytic chlorate reduction (Section 4.3.6.4.4);
- recycling of the brine purge to other production units (Section 4.3.6.4.5).

All these techniques are process-integrated techniques. They aim at reducing the chlorate formation, decomposing chlorate once it is formed, or at using the produced chlorate for other purposes. The techniques are often used in combination.

Current emission levels of chlorate and bromate in waste water at the outlet of the electrolysis unit are presented in Section 3.4.3.3.5. A more detailed analysis revealed that emissions of chlorate from the membrane cell plants covered by the survey were in 17 % of the cases ≤ 100 g/t chlorine produced during normal operation, in 39 % of the cases ≤ 200 g/t chlorine produced, in 56 % of the cases ≤ 300 g/t chlorine produced, in 67 % of the cases ≤ 500 g/t chlorine produced and in 73 % of the cases ≤ 1000 g/t chlorine produced [57, CAK TWG 2012]. Example data from well-performing plants are shown in Sections 4.3.6.4.2, 4.3.6.4.3 and 4.3.6.4.4.

4.3.6.4.2 Brine acidification

Description

This technique consists in acidifying the brine prior to electrolysis, in order to reduce the formation of chlorate and bromate.

Technical description

As seen in the equations in Section 2.1, the formation of chlorate and bromate is reduced by lowering the pH value. In addition, the formation of oxygen is also reduced.

Without acidification, the pH value in the anolyte compartment of membrane cells is approximately 4, due to the disproportionation (dismutation) of chlorine in water and the migration of hydroxide ions from the catholyte compartment through the membrane (about 3–7 % of the hydroxide produced migrates through the membrane, depending on the age and state of the membrane). With acidification, the pH value is typically around 2 [34, Solvay 2010].

Achieved environmental benefits

The achieved environmental benefits of this technique include:

- reduction of chlorate emissions;
- reduction of chloride emissions due to reduced brine purge volumes, if the brine purge rate is determined by the chlorate concentration;
- reduction of water consumption, if the brine purge rate is determined by the chlorate concentration.

Environmental performance and operational data

By using brine acidification, the formation of sodium chlorate can be reduced from approximately 2–3 kg NaClO₃/t Cl₂ produced to < 1 kg NaClO₃/t Cl₂ produced [317, Euro Chlor and ANE 2012]. This corresponds to a reduction from approximately 1.6–2.4 kg ClO₃⁻/t Cl₂ produced to < 0.8 kg ClO₃⁻/t Cl₂ produced.

Example data from well-performing plants using brine acidification are shown in Table 4.30.

Table 4.30: Example data from membrane cell plants using brine acidification with low emissions of chlorate to water in the EU-27 in 2009 to 2011

Plant, location	Emission loads in g/t chlorine produced ⁽¹⁾	Reference year	Year of commissioning	Reference conditions ⁽²⁾
AkzoNobel in Delfzijl (Netherlands)	104	2010	2005	Weekly measurement
AkzoNobel in Rotterdam-Botlek (Netherlands)	135	2010	2006	Monthly measurement
Anwil in Włocławek (Poland)	16.4 ⁽³⁾	2009	2006	Half-yearly measurement with ion chromatography
BASF in Ludwigshafen (Germany)	300	2011	2003	Weekly measurement with ion chromatography
INEOS ChlorVinyls in Rafnes (Norway)	351	2011	2006	Daily measurement with ion chromatography
Vinnolit in Gendorf (Germany)	270 ⁽³⁾	2011	2009	Daily measurement
Vinnolit in Knapsack (Germany)	270 ⁽³⁾	2011	2009	Daily measurement

⁽¹⁾ Annual average values at the outlet of the chlor-alkali plant.
⁽²⁾ Half of the plants use vacuum salt, while the other half use rock salt or solution-mined brine.
⁽³⁾ Plant uses both brine acidification and acidic reduction (Section 4.3.6.4.3).
Source: [57, CAK TWG 2012]

The concentration of oxygen in chlorine can be reduced from 1.5–2.0 vol-% to approximately 0.5–1.0 vol-% by brine acidification [317, Euro Chlor and ANE 2012].

Brine acidification does not lead to overall improved energy efficiency. While it is true that more chlorine is produced in the cells upon brine acidification, the hydrochloric acid needs to be produced or purchased elsewhere, leading to additional energy consumption [216, O'Brien et al. 2005, Section 7.5.6], [317, Euro Chlor and ANE 2012].

Cross-media effects

Additional hydrochloric acid is consumed to lower the pH value.

Technical considerations relevant to applicability

The degree of brine acidification is limited by the resistivity of the equipment used (e.g. membranes and anodes). In membrane cell plants, the limitation is usually set by the membranes. Lowering the pH increases the risk that precipitations of impurities such as iron and aluminium occur inside the membrane, which would otherwise occur outside near the surface (Figure 4.9). In addition, pH values that are too low lead to irreversible modifications of the membrane [34, Solvay 2010], [72, Nishio 2011].

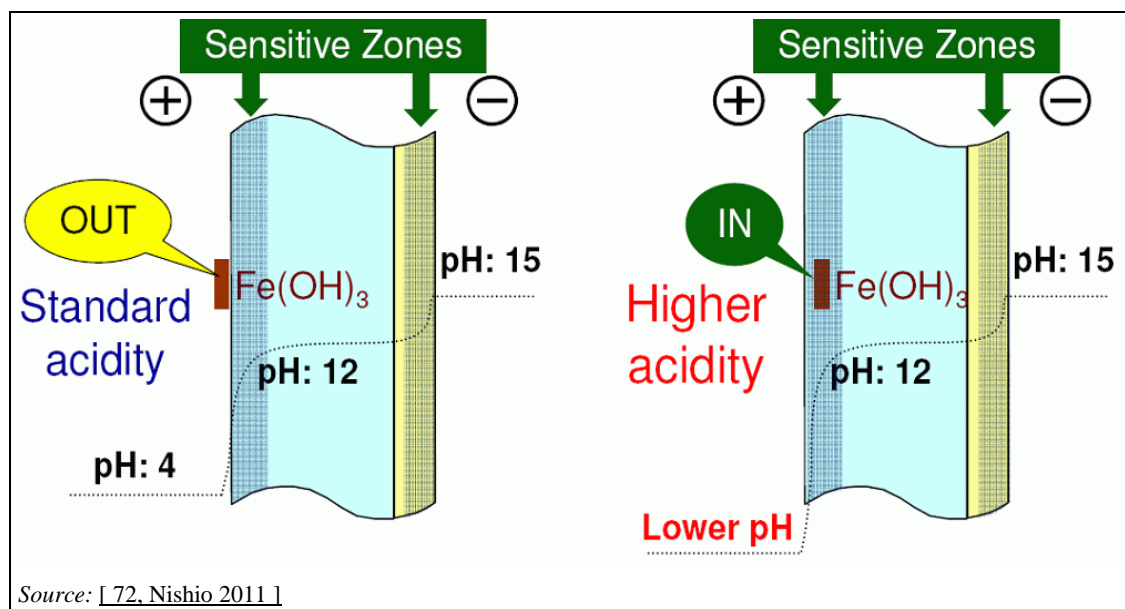

Figure 4.9: Effect of pH value on the location of iron hydroxide precipitation in membranes

If the hydrochloric acid for the brine acidification is purchased, care must be taken to avoid the introduction of impurities that could damage the membranes and/or anodes [317, Euro Chlor and ANE 2012].

Economics

In the case of a plant with a hydrochloric acid production unit, the acid added to the feed brine increases the chlorine efficiency in the cells, but the extra chlorine produced is used as a feed to the hydrochloric acid production unit and there is no extra chlorine generated for other purposes. This is inefficient, since some of the co-produced hydrogen is consumed while considerable amounts of waste heat are generated in the hydrochloric acid burner [317, Euro Chlor and ANE 2012].

In the case of a plant without a hydrochloric acid production unit, the economics depend on the price of the acid. In the case of membrane cell plants, the quality of this acid must be high. When the costs are unfavourable, a plant might choose not to acidify the feed brine [216, O'Brien et al. 2005, Section 7.5.6], [317, Euro Chlor and ANE 2012].

Driving force for implementation

The driving force for implementation of this technique is the improvement of the quality of the products (less oxygen in chlorine, less chlorate in caustic).

Example plants

Brine acidification is frequently applied in chlor-alkali plants. Example plants include:

- AkzoNobel in Delfzijl (Netherlands); chlorine capacity 121 kt/yr;
- AkzoNobel in Rotterdam-Botlek (Netherlands); chlorine capacity 637 kt/yr;
- Anwil in Włocławek (Poland), chlorine capacity 214 kt/yr;

- BASF in Ludwigshafen (Germany); chlorine capacity of membrane cell unit 385 kt/yr;
- INEOS ChlorVinyls in Rafnes (Norway); chlorine capacity 260 kt/yr;
- Vinnolit in Gendorf (Germany); chlorine capacity 180 kt/yr;
- Vinnolit in Knapsack (Germany); chlorine capacity 250 kt/yr.

Reference literature

[34, Solvay 2010], [57, CAK TWG 2012], [72, Nishio 2011], [216, O'Brien et al. 2005], [317, Euro Chlor and ANE 2012]

4.3.6.4.3 Acidic reduction

Description

This technique consists in reducing chlorate to chlorine by using hydrochloric acid at temperatures higher than 85 °C.

Technical description

Acidic chlorate reduction is typically used to treat a side-stream of the depleted brine leaving the cells (Figure 4.10) [1, Ullmann's 2006].

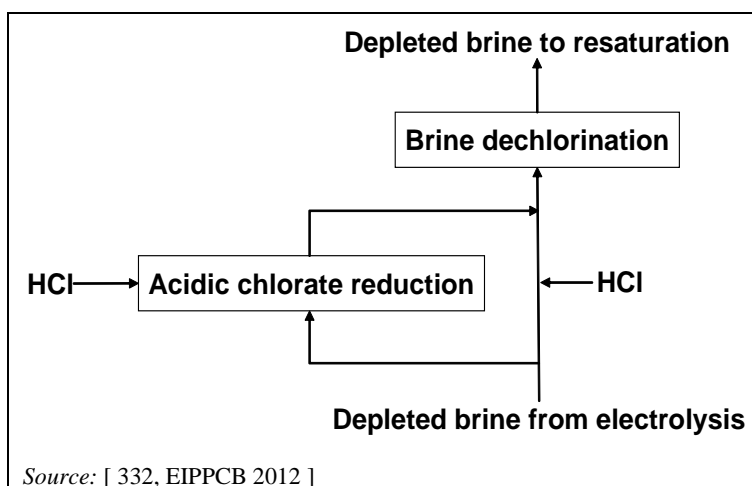

Figure 4.10: Flow diagram of acidic chlorate reduction

During the reaction, chlorate and chloride ions comproportionate (symproportionate) to molecular chlorine, which is removed under vacuum and can be recycled to the process [49, Euro Chlor 2010]:



The reaction is typically carried out at temperatures higher than 85 °C and a pH value of 0 (HCl concentration > 30 g/l). The reactor design needs to take into account the required residence time of the reactants and the corrosive conditions (temperature, pH value, chlorine). Compared to catalytic chlorate reduction (Section 4.3.6.4.4), the technique is easier to implement and to operate [34, Solvay 2010].

Achieved environmental benefits

The achieved environmental benefits of this technique include:

- reduction of chlorate emissions;
- reduction of salt and water consumption, if the brine purge rate is determined by the chlorate concentration;

- reduction of chloride emissions, if the brine purge rate is determined by the chlorate concentration.

Environmental performance and operational data

At the Solvin plant in Lillo-Antwerp (Belgium), a chlorate reduction efficiency of 60–70 % is achieved after treating the depleted brine at 85 °C with hydrochloric acid at a concentration of 30 g/l, a flowrate of 10 m³/h and a residence time of 1 h [34, Solvay 2010]. Residual chlorate levels are typically 1–2 g/l [49, Euro Chlor 2010].

At the MicroBio plant in Fermoy (Ireland), chlorate decomposition takes place at 95–100 °C with an excess of HCl (25–35 g/l), a flowrate of 1.2 m³/h and a residence time of about 1 h. The ratio of the flowrate of the treated side-stream to the total flowrate depends on the membrane efficiency and may vary from 0.5/8 to 1.5/8 (6.3–19 %). The decomposer efficiency is usually higher than 90 %. In general, the decomposer is operated so that the quantity of hydrochloric acid added does not significantly exceed the quantity that would anyway be necessary for the acidification of the brine, thereby reducing the consumption of ancillary materials (HCl and NaOH) and related costs. [121, MicroBio 2012].

The purge rate at this plant is determined by the sodium chlorate concentrations in the brine circuit. The chlorate decomposer has enabled the purge rate to be reduced from approximately 1 200 l/h to 200–300 l/h, depending on the membrane efficiency. This has resulted in similar reductions of emission loads for chloride, sulphate and chlorate from the brine purge. In 2011, the average emission load for chlorate was estimated to be approximately 2.3 kg/t chlorine produced [121, MicroBio 2012]. This emission load is, however, still rather high compared to those of other well-performing plants using acidic reduction (Table 4.31).

Table 4.31: Example data from membrane cell plants using acidic reduction with low emissions of chlorate to water in the EU-27 in 2008 to 2011

Plant, location	Emission loads in g/t chlorine produced ⁽¹⁾	Reference year	Year of commissioning	Reference conditions ⁽²⁾
Anwil in Włocławek (Poland)	16.4 ⁽³⁾	2009	2006	Half-yearly measurement with ion chromatography
Donau Chemie in Brückl (Austria)	500	2008	1999	Estimated/calculated value
Vinnolit in Gendorf (Germany)	270 ⁽³⁾	2011	2009	Daily measurement
Vinnolit in Knapsack (Germany)	270 ⁽³⁾	2011	2009	Daily measurement
Wacker in Burghausen (Germany)	30	2009	2000	Estimated/calculated value; dl = 0.1 g/l

⁽¹⁾ Annual average values at the outlet of the chlor-alkali plant.
⁽²⁾ Most of the plants use rock salt or solution-mined brine.
⁽³⁾ Plant uses both brine acidification and acidic reduction (Section 4.3.6.4.3).
 NB: dl = detection limit.
 Source: [57, CAK TWG 2012]

Cross-media effects

Some raw materials and energy are consumed for the construction of the reactor.

During operation, steam might be necessary for heating the reactor, and hydrochloric acid is consumed for the reaction. In addition, sodium hydroxide is required for the neutralisation of the

reactor effluent, which is necessary for the primary brine treatment. To reduce this consumption of sodium hydroxide, the treated brine leaving the reactor is sent to the dechlorination unit, in order to reuse a maximum of the HCl excess (Figure 4.10) [34, Solvay 2010]. Depending on the ratio of the flowrate of the side-stream to that of the depleted brine, it may not be necessary to add more hydrochloric acid than would anyway be required for the brine dechlorination step. In this case, there is also no additional consumption of sodium hydroxide. The use of steam may also not be necessary. For example, acidic chlorate reduction without an additional consumption of hydrochloric acid, sodium hydroxide or steam was operated in the combined mercury/membrane cell plant of Vestolit in Marl from 1998 to 2007 [316, Euro Chlor 2012]. Chlorine dioxide may be formed in a side reaction and require an additional treatment of the gaseous reactor effluent (Section 4.3.5.2) [34, Solvay 2010], [192, Euro Chlor 2011], [216, O'Brien et al. 2005, Section 7.5.9.4]:

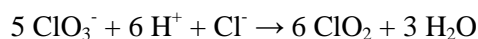

Technical considerations relevant to applicability

Generally, there are no technical restrictions to the applicability of this technique. Diaphragm cell plants do not recirculate the brine and therefore do not use acidic chlorate reduction. Any chlorate produced during electrolysis leaves the process with the caustic liquor.

Economics

At the MicroBio plant in Fermoy (Ireland), investment costs for the chlorate decomposer with a maximum capacity of 1800 l/h amounted to EUR 0.12 M in 2003/2004 (including equipment and process control; excluding design, installation and commissioning). Operating costs result mainly from the consumption of hydrochloric acid and steam, while savings result from reduced salt consumption and the production of chlorine in the decomposer. The simple payback time was approximately 1.5 years [121, MicroBio 2012].

In plants with once-through brine systems, acidic reduction would require a significant investment for a large reactor, if the depleted brine was to be treated in its entirety.

Driving force for implementation

The driving forces for implementation of this technique include:

- improvement of product quality (less chlorate in caustic);
- reduction of costs related to salt and water consumption, if the brine purge rate is determined by the chlorate concentration;
- environmental legislation.

Example plants

Acidic chlorate reduction is used by many membrane cell plants. Example plants include:

- Anwil in Włocławek (Poland) chlorine capacity 214 kt/yr;
- Donau Chemie in Brückl (Austria), chlorine capacity 70 kt/yr;
- MicroBio in Fermoy (Ireland), chlorine capacity 9 kt/yr;
- Solvin in Antwerp-Lillo (Belgium), chlorine capacity 350 kt/yr;
- Vestolit in Marl (Germany), acidic chlorate reduction operated from 1998 to 2007, chlorine capacity at that time 216 kt/yr.
- Vinnolit in Gendorf (Germany); chlorine capacity 180 kt/yr;
- Vinnolit in Knapsack (Germany); chlorine capacity 250 kt/yr;
- Wacker Chemie in Burghausen (Germany), chlorine capacity 50 kt/yr.

Reference literature

[1, Ullmann's 2006], [34, Solvay 2010], [49, Euro Chlor 2010], [57, CAK TWG 2012], [121, MicroBio 2012], [192, Euro Chlor 2011], [216, O'Brien et al. 2005], [316, Euro Chlor 2012]

4.3.6.4.4 Catalytic reduction

Description

This technique consists in reducing chlorate to chloride and bromate to bromide in a pressurised trickle-bed reactor by using hydrogen and a rhodium catalyst in a three-phase reaction.

Technical description

Similar to acidic chlorate reduction (Section 4.3.6.4.3), catalytic chlorate reduction is typically used to treat a side-stream of the depleted brine leaving the cells. Chlorate is reduced to chloride by the reaction with hydrogen in the presence of a rhodium metal catalyst on an activated carbon carrier [34, Solvay 2010], [49, Euro Chlor 2010]:

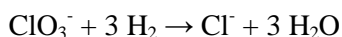

The reaction occurs in a pressurised trickle-bed reactor in the presence of a gas (hydrogen), a liquid (brine) and a solid (the catalyst). Hydrogen is used in excess and the heat generated during the exothermic reaction is removed with the brine [34, Solvay 2010].

The technique has the advantage of not requiring huge amounts of sodium hydroxide for neutralisation. Hydrogen is also readily available at chlor-alkali plants. However, the technique is more difficult to operate than acidic chlorate reduction (Section 4.3.6.4.3). The catalyst may be destroyed by high temperatures, frequent start-up and shutdown operations, high chlorate concentrations and the absence of a reducing atmosphere in the presence of brine. The reactor start-up is therefore carried out in an oxygen-free atmosphere before adding hydrogen, and the reactor shutdown involves rinsing with demineralised water before removing hydrogen [34, Solvay 2010].

The first reactor with catalytic chlorate reduction was put into operation in 2001 [49, Euro Chlor 2010].

Achieved environmental benefits

The achieved environmental benefits of this technique include:

- reduction of chlorate emissions;
- reduction of salt and water consumption, if the brine purge rate is determined by the chlorate concentration;
- reduction of chloride emissions, if the brine purge rate is determined by the chlorate concentration.

Environmental performance and operational data

The efficiency of the reduction is typically in the range of 99.6–99.8 %, with a chlorate concentration in the inlet of about 5 000 mg/l and outlet concentrations of 10–20 mg/l. However, if the inlet concentration is lower (e.g. 800 mg/l), the outlet concentration remains at 10–20 mg/l, reducing the efficiency to 97.5–98.8 % [34, Solvay 2010].

Any bromate present in the brine is similarly reduced to bromide, the reduction efficiency being better than in the case of chlorate [34, Solvay 2010].

In 2008, the Solvic plant in Jemeppe (Belgium) reported an annual average emission load for chlorate at the outlet of the chlor-alkali plant of 0.92 g/t [57, CAK TWG 2012].

Cross-media effects

Some raw materials and energy are consumed for the construction and operation of the reactor. The hydrogen used for catalytic chlorate reduction cannot be used for other purposes.

Technical considerations relevant to applicability

There are no restrictions to the applicability of this technique. Diaphragm cell plants do not recirculate the brine and therefore do not use catalytic chlorate reduction. Any chlorate produced during electrolysis leaves the process with the caustic liquor.

Economics

In plants with once-through brine systems, catalytic reduction would require a significant investment for a large reactor, if the depleted brine was to be treated in its entirety.

Driving force for implementation

The driving forces for implementation of this technique include:

- improvement of product quality (less chlorate in caustic);
- reduction of costs related to salt and water consumption, if the brine purge rate is determined by the chlorate concentration;
- environmental legislation.

Example plants

- Solvin in Antwerp-Lillo (Belgium), chlorine capacity 350 kt/yr;
- Solvic in Jemeppe (Belgium), chlorine capacity 174 kt/yr;
- Solvay in Rosignano (Italy), chlorine capacity 150 kt/yr;
- Solvay in Tavaux (France), chlorine capacity 360 kt/yr.

Reference literature

[34, Solvay 2010], [49, Euro Chlor 2010], [57, CAK TWG 2012]

4.3.6.4.5 Use of waste water streams containing chlorate in other production units**Description**

This technique consists in recycling waste water streams containing chlorate from the chlor-alkali plant to other production units. A common application of this technique is the recycling of the brine purge to the production of sodium chlorate.

Technical description

Sodium chlorate is principally used to produce chlorine dioxide, which is used as a bleaching agent in the pulp and paper industry. The production of sodium chlorate is based on the electrolysis of brine under pH conditions where the chlorine from the anode combines with the sodium hydroxide from the cathode to produce sodium hypochlorite, which is converted to sodium chlorate. The reactions involved are the same as those occurring as side reactions in chlor-alkali electrolysis cells (Section 2.1). Following electrolysis, the cell liquor is stored in tanks to finalise the transformation of hypochlorite to chlorate. Sodium chlorate is obtained from the cell liquor by concentration in a crystallisation unit, with subsequent washing. The mother liquid and the washing liquids are re-concentrated using solid salt or evaporation and are recycled to the brine circuit [209, COM 2007].

By recycling the brine purge of a chlor-alkali electrolysis unit to the brine system of a sodium chlorate production unit, the chlorate produced as an unwanted substance is converted into a saleable product. Any bromate in the brine purge from the chlor-alkali unit will leave the site with the crystallised sodium chlorate or with the brine purge from the sodium chlorate unit.

Achieved environmental benefits

The achieved environmental benefits of this technique include:

- reduction of chlorate emissions;
- overall reduction of raw material and energy consumption;
- overall reduction of chloride emissions, due to reduced brine purge volumes.

Environmental performance and operational data

At the Electroquímica de Hernani plant in Hernani (Spain) and the Kemira plant in Joutseno (Finland), the brine purge from the membrane cell chlor-alkali unit is completely recycled to the sodium chlorate production unit [57, CAK TWG 2012].

Cross-media effects

There are no additional cross-media effects for a site which produces both chlorine and sodium chlorate.

Technical considerations relevant to applicability

The use of this technique is restricted to sites which can make use of waste water streams of this quality in other production units.

In the case of recycling of the brine purge to a sodium chlorate plant, restrictions may arise from the following [216, O'Brien et al. 2005, Section 7.5.7.2A], [293, Euro Chlor 2012]:

- The size of the chlorate plant: it may not be possible to purge a sufficient volume of brine.
- The salt concentration: if the purge (depleted brine) cannot be resaturated in the chlorate plant, it may be necessary to purge saturated brine, thereby increasing the purge volume. Alternatively, a separate saturator for the purge stream could be installed, however at an additional cost.
- The sulphate concentration: the sulphate in the brine purge may lead to problems with the required product specifications of sodium chlorate, in particular for the solid product.

Economics

No information provided.

Driving force for implementation

The driving force for implementation of this technique is a reduction of operating costs, due to the reduced consumption of raw materials and energy.

Example plants

- Electroquímica de Hernani in Hernani (Spain), chlorine capacity 15 kt/yr;
- Kemira in Joutseno (Finland), chlorine capacity 75 kt/yr.

Reference literature

[57, CAK TWG 2012], [209, COM 2007], [216, O'Brien et al. 2005], [293, Euro Chlor 2012]

4.3.6.5 Techniques to reduce emissions of halogenated organic compounds

Description

These techniques consist in reducing the levels of organic contaminants in the brine, in order to diminish the formation of halogenated organic compounds.

Technical description

The formation of halogenated organic compounds in the brine system can be reduced by:

- careful selection and control of the salt and ancillary materials with respect to organic impurities;
- process water purification, using techniques such as membrane filtration, ion exchange, UV irradiation and adsorption on activated carbon;
- careful selection of equipment, such as cells, pipes, valves and pumps, to reduce the potential leaching of organic contaminants to the brine.

The levels of organic contaminants in the brine system are usually kept low in order to meet the specifications of the equipment (e.g. electrodes, diaphragms and membranes). This is especially true for the membrane cell technique, where the concentration of total organic carbon is usually required to be in the range of 1–10 ppm (Table 2.4).

End-of-pipe techniques to reduce emissions of halogenated organic compounds are very rarely used.

Achieved environmental benefits

The achieved environmental benefit of these techniques is a reduction of emissions of halogenated organic compounds.

Environmental performance and operational data

Current emission levels of halogenated organic compounds at the outlet of the electrolysis unit are presented in Section 3.4.3.3.8. AOX emission loads of 0.2–0.5 g/t chlorine produced are achieved by some membrane cell plants [57, CAK TWG 2012].

Cross-media effects

A change of the salt source may lead to higher overall energy consumption and emissions, if the transport distance increases. Additional purification steps for salt, water or ancillary materials may lead to the consumption of additional energy and ancillary materials and to the generation of additional waste.

Technical considerations relevant to applicability

Generally, there are no technical restrictions to the applicability of these techniques.

Economics

No information provided.

Driving force for implementation

The driving forces for implementation of these techniques include:

- reduction of costs related to equipment and maintenance;
- environmental legislation.

Example plants

Techniques to reduce the levels of organic contaminants in the brine are used by many membrane cell plants.

Reference literature

[57, CAK TWG 2012]

4.3.7 Techniques to reduce the generation of sulphuric acid waste

4.3.7.1 Use on site or off site

Description

This technique consists in using the spent sulphuric acid from chlorine drying instead of neutralising and discharging it.

Technical description

Concentrated sulphuric acid (92–98 wt-%) is used to dry chlorine. Up to 35 kg of acid is consumed per tonne of chlorine produced (Sections 2.6.5 and 3.3.3). The spent acid can be used to control the pH in the process and waste water streams or to destroy surplus hypochlorite if there is a respective demand on site. It can also be reconcentrated (Section 4.3.7.2) or sold as a by-product to any user who can use this quality of acid [33, Euro Chlor 2011], [54, Euro Chlor

2010]. Typical uses include the production of ammonium sulphate (fertilisers) and aluminium sulphate (water treatment, paper manufacturing) [57, CAK TWG 2012].

Achieved environmental benefits

The achieved environmental benefits of these techniques include:

- reduction of raw material and energy consumption, due to a replacement of fresh sulphuric acid;
- reduction of sulphate emissions and caustic consumption, if the spent acid would otherwise be neutralised and discharged.

Environmental performance and operational data

In the two surveys in 2010 and 2012, 31 out of 35 chlor-alkali plants in the EU-27 and EFTA countries (equivalent to more than 85 %) reported that no sulphuric acid waste was generated. 22 of these 31 plants mainly used the spent sulphuric acid on site or off site, 6 plants mainly reconcentrated it and 3 plants did not provide information on the fate of the acid (Table 3.26) [57, CAK TWG 2012].

Cross-media effects

There are no cross-media effects.

Technical considerations relevant to applicability

Generally, there are no technical restrictions to the applicability of these techniques.

Economics

The on-site or off-site use of spent sulphuric acid of this quality depends on the existence of a respective demand.

Driving force for implementation

The driving force for implementation of these techniques is economics (i.e. generation of revenues from the sale of sulphuric acid, savings due to replacement of fresh sulphuric acid).

Example plants

Many plants use the spent sulphuric acid for other purposes on site or off site.

Reference literature

[33, Euro Chlor 2011], [54, Euro Chlor 2010], [57, CAK TWG 2012]

4.3.7.2 Reconcentration of spent sulphuric acid

Description

This technique consists in reconcentrating spent sulphuric acid on site or off site in closed-loop evaporators under vacuum by indirect heating or by strengthening using sulphur trioxide.

Technical description

When using closed-loop evaporators, the reconcentration is usually carried out in two stages. The first evaporator is typically operated at approximately 80 mbar and concentrates the acid to 90 wt-%, while the second is typically operated at 15–20 mbar to reach a final acid concentration of 96 wt-%. The vapours from both evaporators pass through a scrubbing column, before being condensed in a condenser. The scrubbing column is necessary due to the steep increase of the sulphuric acid content in the gas phase at liquid concentrations > 75 wt-%. The condensate is used as working liquid for the vacuum generation via steam ejection, before being discharged. The product acid leaves the boiler and is cooled down [47, De Dietrich 2011].

Alternatively, the spent sulphuric acid can be reconcentrated by using sulphur trioxide.

Materials used must be highly corrosion-resistant to avoid corrosion problems, in particular if the feed acid is polluted.

The reconcentration can be carried out on site or off site.

Achieved environmental benefits

The achieved environmental benefits of this technique include:

- reduction of sulphuric acid consumption;
- reduction of sulphate emissions and caustic consumption, if the spent acid would otherwise be neutralised and discharged.

Environmental performance and operational data

Operational data provided by one equipment provider are shown in Table 4.32.

Table 4.32: Typical operational data from an on-site sulphuric acid reconcentration system

Stream	Characteristics	Flow
Spent acid	78 wt-% H ₂ SO ₄ (~ 0.03 wt-% Cl ₂ , Salts ≤ 0.85 wt-%) ⁽¹⁾	1 500 kg/h
Reconcentrated acid	96 wt-% H ₂ SO ₄ (including salts)	1 214 kg/h
Condensate	≤ 1 wt-% H ₂ SO ₄	450.5 kg/h
Waste gas	~ 38 wt-% air, ~ 56 wt-% Cl ₂	0.8 kg/h
Heating steam	6 bar, 201 °C	665 kg/h ⁽²⁾
Motive steam	6 bar, 201 °C	165 kg/h ⁽³⁾
Cooling water	4 bar, 25 °C supply temperature, 30 °C return temperature	67 m ³ /h
Power	400 V, 50 Hz, 3 phase	7 kW ⁽⁴⁾

⁽¹⁾ Depending on the salt concentration, a number of cleaning cycles per year are required.
⁽²⁾ The consumption of heating steam can be reduced by ~ 160 kg/h if an electrical heater is used (second stage).
⁽³⁾ Motive steam is not required if an electrical heater is used (second stage).
⁽⁴⁾ The power consumption increases by 85 kW if an electrical heater is used (second stage).
Source: [47, De Dietrich 2011]

By using a reconcentration system, the consumption of sulphuric acid (96 wt-%) can be reduced to ≤ 0.1 kg/t Cl₂ produced [47, De Dietrich 2011].

In the two surveys in 2010 and 2012, 31 out of 35 chlor-alkali plants in the EU-27 and EFTA countries (equivalent to more than 85 %) reported that no sulphuric acid waste was generated. 22 of these 31 plants mainly used the spent sulphuric acid on site or off site, 6 plants mainly reconcentrated it and 3 plants did not provide information on the fate of the acid (Table 3.26) [57, CAK TWG 2012].

Cross-media effects

Raw materials and energy are consumed for the installation and operation of the reconcentration unit. Emissions to air may be generated, depending on the presence of contaminants in the feed acid. Waste water is generated in the condensers/vacuum generators. A small purge of the acid is usually necessary to avoid the build-up of contaminants in the concentrated acid [47, De Dietrich 2011].

Technical considerations relevant to applicability

On-site reconcentration in closed-loop evaporators can be applied at new and existing plants. The required installation area depends on the capacity of the plant.

Economics

The investment costs depend on the customer's requirements. In 2011, one equipment provider reported investment costs of EUR 1 million for a two-stage unit capable of concentrating 1.5 tonnes of 78 wt-% H₂SO₄ per hour to 96 wt-% H₂SO₄. The capacity is equivalent to 13.7 kt H₂SO₄ (78 wt-%)/yr and, assuming a consumption of 20 kg H₂SO₄ (96 wt-%)/t chlorine produced, would be sufficient to reconcentrate the spent acid of a plant with a chlorine capacity of 657 kt/yr. In the case of a final concentration of 92 wt-%, the concentration can be carried out in one stage and the investment costs would be reduced to EUR 0.75 million. The operating costs mainly depend on the energy costs [47, De Dietrich 2011].

Savings result from the reduced consumption of sulphuric acid.

Off-site reconcentration usually requires the transport of the spent acid, resulting in additional costs.

Driving force for implementation

The driving forces for implementation of this technique include:

- reduction of costs related to the consumption of sulphuric acid;
- lack of opportunities to use or sell the spent acid.

Example plants

In 2011, one equipment provider reported having installed more than 90 on-site sulphuric acid concentration units worldwide, of which approximately one-third were located on chlor-alkali sites [47, De Dietrich 2011]. Example plants include [57, CAK TWG 2012]:

- AkzoNobel in Bitterfeld (Germany), chlorine capacity 99 kt/yr;
- AkzoNobel in Ibbenbüren (Germany), chlorine capacity 125 kt/yr;
- AkzoNobel in Frankfurt (Germany), chlorine capacity 167 kt/yr;
- Borsodchem in Kazincbarcika (Hungary), chlorine capacity 291 kt/yr;
- Chimcomplex in Borzești (Romania), chlorine capacity 93 kt/yr;
- Vestolit in Marl (Germany), chlorine capacity 260 kt/yr.

Reference literature

[47, De Dietrich 2011], [57, CAK TWG 2012]

4.3.8 Techniques to reduce emissions of noise

Techniques to reduce emissions of noise are of general relevance for the chemical industry and are not specific to the chlor-alkali industry. These techniques are therefore covered by the reference document on Common Waste Water and Waste Gas Treatment/Management Systems in the Chemical Sector (CWW BREF).

4.4 Techniques for the remediation of contaminated sites

4.4.1 Overview

The techniques described in Sections 4.4.2 to 4.4.4 apply to contaminated sites where the mercury and/or the diaphragm cell technique were used, except when reference is made to mercury decontamination, which applies only to mercury cell plants.

The Industrial Emissions Directive requires operators to prepare a baseline report before starting operation of an installation or before a permit update after 7 January 2013 where there is a possibility of soil and groundwater contamination with relevant hazardous substances. The baseline report shall contain information on [\[77, Directive 2010/75/EU 2010 \]](#):

- the present use and, where available, on past uses of the site;
- existing or new information on soil and groundwater measurements of relevant hazardous substances.

Upon definitive cessation of the activities, the operator shall assess again the state of soil and groundwater. Where the installation has caused significant pollution compared to the state established in the baseline report, the operator shall take the necessary measures to return the site to that state. For that purpose, the technical feasibility of such measures may be taken into account [\[77, Directive 2010/75/EU 2010 \]](#).

Furthermore, the Industrial Emissions Directive requires that, independently of the baseline report, upon definitive cessation of the activities, and where the contamination of soil and groundwater at the site poses a significant risk to human health or the environment as a result of the permitted activities, the operator shall take the necessary actions aimed at the removal, control, containment or reduction of relevant hazardous substances, so that the site, taking into account its current or approved future use, ceases to pose such a risk [\[77, Directive 2010/75/EU 2010 \]](#).

4.4.2 Site remediation plan

Description

This technique consists in devising and implementing a site remediation plan for the contaminated site.

Technical description

A site remediation plan allows operators of installations to address soil and groundwater contamination issues in a systematic and demonstrable way. The successive steps of the plan are implemented in a dynamic way, depending on the results of each step. In general terms, the plan follows the approach of Environmental Management Systems.

A site remediation plan is often devised and implemented after taking the decision to decommission the plant. However, other requirements may dictate devising and implementing a (partial) site remediation plan while the plant is still in operation.

In most cases, a site clean-up follows a systematic procedure because the types of contaminants and the contamination levels are initially unknown. A first study that covers a large area is usually followed by more detailed studies on particular areas where contamination was found. This means that the successive steps of the plan usually last quite a long time.

A site remediation plan may provide for the following steps which, depending on other requirements, can overlap, be skipped or be carried out in another order [\[245, Euro Chlor 2012 \]](#):

1. Emergency implementation of techniques to cut off the exposure pathways and the expansion of the contamination by:
 - a. hydraulic containment (e.g. pump-and-treat systems);
 - b. mechanical containment (e.g. horizontal capping or vertical low-permeability barriers in the subsurface);
 - c. site use restrictions (i.e. receptor control).
2. Desk study to identify the origin, extent and composition of the contamination (interviews and photo interpretations may be useful tools). Typical pollutants that can be present on contaminated chlor-alkali sites include mercury, PCDDs/PCDFs and PCNs (Section 3.8).
3. Characterisation of the contamination by:
 - a. initial screening survey to rapidly assess the presence of contaminated areas;
 - b. confirmation survey to quantify the extent and intensity of the contamination;
 - c. preparation of a report on the state of soil and groundwater contamination (in accordance with the guidance to be established by the Commission following Article 22 (2) of the Directive);
 - d. estimation of the time and costs of the remediation.
4. Assessment of the risk for receptors over time and space, taking into account the current and approved future use of the site. Current models only give a picture of the risk over space at the present time. These models generally use total concentration input data and assume fixed coefficients for the real impact on environmental and human receptors while site-specific parameters such as speciation and mobility are not taken into account. A sensitivity analysis might therefore be useful when assessing the parameters used within the risk assessment [245, Euro Chlor 2012].
5. Preparation of an engineering project including:
 - a. decontamination and/or permanent containment;
 - b. timetables;
 - c. a monitoring plan;
 - d. financial planning and investment to achieve the target.
6. Decontamination phase: implementation of the engineering project so that the contaminated site, taking account of its current use and approved future use, no longer poses any significant risk to human health or the environment. Depending on other obligations, the engineering project might have to be implemented in a more stringent manner (Section 4.4.1).
7. Site use restrictions if necessary due to residual contamination and taking into account the current and approved future uses of the site.
8. Associated monitoring at the site and in the surrounding areas to verify that the objectives are achieved and maintained.

The implementation of Steps 5 to 8 depends on the results of the risk assessment carried out in Step 4.

Achieved environmental benefits

The achieved environmental benefits of this technique include:

- reduction of contamination in soil, groundwater and air;
- halting of pollution dispersion and transfer to biota.

Environmental performance and operational data

Environmental performance and operational data are inherently linked to the applied containment and decontamination techniques (Sections 4.4.3 and 4.4.4).

Cross-media effects

Pollutants may be mobilised during the implementing phases of the site remediation plan if these are not properly managed.

Technical considerations relevant to applicability

Generally, there are no technical restrictions to the applicability of this technique.

Economics

A sound site remediation plan forms the basis for efficient spending on site remediation.

Decontamination techniques are much more expensive than containment techniques.

Driving force for implementation

The driving forces for implementation of this technique include:

- environmental legislation;
- reduction of costs.

Example plants

A site remediation plan is often devised and implemented for the remediation of contaminated chlor-alkali sites after taking the decision to decommission the plant, although other requirements may dictate a (partial) site remediation plan while the plant is still in operation.

Reference literature

[240, Otto et al. 2006], [244, Hinton and Veiga 2001], [245, Euro Chlor 2012], [262, Ilyushchenko et al. 2008]

4.4.3 Containment**Description**

Containment techniques consist in cutting off the exposure pathway from a contaminated site towards receptors. This is achieved by confinement of the contaminated material, either at the original location or after removal.

Technical description

For the containment of contaminated soil at the original location, barriers such as cappings or cut-off walls are frequently used, either during emergency preliminary activities or as permanent techniques. Otherwise, the polluted soil or sediment is removed and confined in a permanent storage facility. If necessary, the incurring groundwater is treated. The excavated soil is then replaced with uncontaminated soil.

Each cut-off wall system has limitations with respect to emplacement depth and to uncertainty concerning permeability. Barriers may be used to surround the contaminated zone entirely or to remove the potential for groundwater flow through the source. Examples include slurry walls, grout walls/curtains and sheet pile walls. For cappings, low permeability materials, such as compacted clays, natural soils mixed with stabilisers or bentonite, or geosynthetic membranes are frequently used to inhibit infiltration [244, Hinton and Veiga 2001].

At a mercury cell chlor-alkali site in Skutskär (Sweden), a decision was made to build a barrier and dredge the sediment from the bottom of the harbour area and place it behind the barrier. The volume of sediment was 500 000 m³ and the amount of mercury 4000 kg. The content of mercury varied between 1 and 110 mg/kg dry substance, with an average of 24 mg/kg [75, COM 2001], [278, Verberne and Maxson 2000].

At a mercury cell chlor-alkali site in Pavlodar (Kazakhstan), the following containment techniques were implemented from 2002 to 2005 [262, Ilyushchenko et al. 2008]:

- construction of bentonite cut-off walls (15–20 m deep, 0.5 m wide) underneath the cell room building, by backfilling a trench with a mixture of bentonite clay and water which was deep enough to reach water-resistant basalt clay below the aquifer;
- removal of the upper soil layer outside the cut-off wall (50 cm depth, mercury content > 10 mg /kg) and replacement with clean soil;
- use of a monitoring network with more than 100 observation boreholes.

At a mercury and diaphragm cell chlor-alkali site in Rheinfelden (Germany), the PCDD/PCDF-contaminated soil with $> 1 \mu\text{g TEQ/kg}$ was removed and substituted or, in some cases, was contained by removing the topsoil, fitting a geo textile and covering the bottom soil again with non-contaminated soil. The largest share of contaminated soil with PCDD/PCDF concentrations $< 10 \mu\text{g TEQ/kg}$ was deposited on a landfill, while most of the soil with PCDD/PCDF concentrations $> 10 \mu\text{g TEQ/kg}$ was incinerated as hazardous waste. Soil with PCDD/PCDF concentrations $< 1 \mu\text{g TEQ/kg}$ remained, with no action taken but restrictions to agricultural use applied [240, Otto et al. 2006].

Achieved environmental benefits

The achieved environmental benefit of this technique is a prevention of pollution dispersion and transfer to biota.

Environmental performance and operational data

At a mercury cell chlor-alkali site in Pavlodar (Kazakhstan), the mercury concentrations in groundwater inside the site perimeter remained high after the implementation of containment techniques, while significant local decreases were observed outside [262, Ilyushchenko et al. 2008].

Cross-media effects

If the contaminated soil is removed, additional emissions may result from the mobilisation of pollutants, and additional soil is required to substitute the confined soil.

Raw materials and energy are used for the confinement.

Technical considerations relevant to applicability

Some containment techniques are restricted by existing buildings and underground equipment. The removal of soil can be difficult if the contamination is present at some depth and/or in the presence of an aquifer [245, Euro Chlor 2012].

Economics

Containment techniques are more economical than decontamination techniques.

The total costs for site remediation in Rheinfelden (Germany), including incineration of the soil fraction with the heaviest PCDD/PCDF contamination, amounted to EUR 24 million. A complete decontamination was considered to be uneconomical, due to the elevated costs and the fact that the risk of groundwater contamination with PCDDs/PCDFs was excluded [240, Otto et al. 2006].

Driving force for implementation

The driving forces for implementation of this technique include:

- environmental legislation;
- reduction of costs.

Example plants

- Mercury cell plant in Skutskär (Sweden), in operation from 1949 to 1977 [75, COM 2001], [278, Verberne and Maxson 2000];
- Mercury cell plant in Pavlodar (Kazakhstan), put into operation in 1975, chlorine capacity 100 kt/yr [262, Ilyushchenko et al. 2008];
- Mercury and diaphragm cell plant in Rheinfelden (Germany), put into operation in 1890 [240, Otto et al. 2006].

Reference Literature

[75, COM 2001], [240, Otto et al. 2006], [244, Hinton and Veiga 2001], [245, Euro Chlor 2012], [262, Ilyushchenko et al. 2008], [278, Verberne and Maxson 2000]

4.4.4 Decontamination

4.4.4.1 Overview

Decontamination is frequently carried out by excavation of the soil and *ex situ* treatment, either on site or off site, while *in situ* treatment is less frequently applied.

Excavated contaminated soil is waste according to the Waste Framework Directive. It falls under Chapter 17 05 of the European List of Waste. Depending on the properties, the excavated contaminated soil may fulfil the criteria for hazardous waste [145, Decision 2000/532/EC 2000], [269, Waste Framework Directive 98/EC 2008].

Ex situ techniques for decontamination are therefore described in the Waste Treatments Industries BREF (e.g. immobilisation, thermal desorption, vapour extraction, solvent extraction, soil washing) [267, COM 2006] and the Waste Incineration BREF (e.g. incineration, mercury abatement, PCDD/PCDF abatement) [268, COM 2006]. The techniques described in Sections 4.4.4.2 and 4.4.4.3 constitute specific examples of waste treatments relevant for contaminated chlor-alkali sites.

Table 4.33 summarises potential techniques for the decontamination of mercury-contaminated soils.

Table 4.33: Potential techniques for the decontamination of mercury-contaminated soils

Technique	Description
Thermal desorption	Thermal desorption is an <i>ex situ</i> physical technique to remove mercury from the contaminated medium. Heat is supplied under reduced pressure to the contaminated soil or waste, volatilising mercury. The waste gas is treated by condensation to generate liquid elemental mercury. The waste gas may require further treatment, depending on the presence of other pollutants. The technique has been used on a full scale, including at chlor-alkali sites (Section 4.4.4.2).
Vapour extraction	Vapour extraction is based on <i>in situ</i> volatilisation of mercury by applying vacuum and heat, followed by treatment of the waste gases. The technique has been used on a full scale, but not at chlor-alkali sites.
Soil washing and extraction	Soil washing is an <i>ex situ</i> technique that takes advantage of the behaviour of mercury to preferentially adsorb onto fine particles. The contaminated soil is suspended in a wash solution and the fine particles are separated from the suspension, thereby reducing the contaminant concentration in the remaining soil. The extraction of mercury from the fine particles fraction can be based on the desorption of adsorbed species, oxidation of metallic mercury, complexation and dissolution (e.g. by using acids). The technique has been used on a full scale, including at chlor-alkali sites (Section 4.4.4.3).
Solidification and stabilisation	Solidification and stabilisation are <i>ex situ</i> techniques which reduce the mobility of hazardous substances and contaminants in the environment through both physical and chemical means. This technique physically binds or encloses contaminants within a stabilised mass and chemically reduces the hazard potential by converting the contaminants into less soluble, mobile, or toxic forms. Amalgamation is typically used to immobilise elemental mercury and is often combined with encapsulation to prevent volatilisation of mercury from the amalgam. The technique has been used on a full scale, including at chlor-alkali sites. Soluble mercury may be immobilised <i>in situ</i> by precipitation as mercury sulphide.
Vitrification	Vitrification is a high-temperature treatment designed to immobilise contaminants <i>ex situ</i> or <i>in situ</i> by incorporating them in the vitrified end-product, which is chemically durable and leach-resistant. The primary residue generated by this technique is typically glass cullet or aggregate. Secondary residues generated are air emissions, scrubber liquor, carbon filters, and used hood panels. This technique may also cause contaminants to volatilise or undergo thermal destruction, thereby reducing their concentration in the soil. The technique has been used on a full scale, but not at chlor-alkali sites.
<i>Source:</i> [244, Hinton and Veiga 2001], [245, Euro Chlor 2012], [266, US EPA 2007]	

Techniques for treating mercury-contaminated waste water arising during decontamination are described in Section 4.1.3.1 and in the CWW and WT BREFs [124, EC 2003], [267, COM 2006]. Techniques for treating mercury-containing waste gases arising during decontamination are described in Section 4.1.3.1 and in the WT and WI BREFs [267, COM 2006], [268, COM 2006].

4.4.4.2 Thermal desorption

Description

This technique consists in heating excavated soil (on site or off site) to volatilise mercury and other organic compounds (e.g. PCDDs/PCDFs and halogenated organic compounds), with subsequent treatment of the resulting waste gases.

Technical description

A summary description is provided in Table 4.33. Operating temperatures for thermal desorption typically range from 320 °C to more than 800 °C. Thermal desorption can be carried out with the help of vacuum or vibrating equipment [245, Euro Chlor 2012], [263, Khrapunov et al. 2007], [266, US EPA 2007].

Achieved environmental benefits

The achieved environmental benefit of this technique is the decontamination of soil.

Environmental performance and operational data

The temperature and residence time are the most important factors for the efficiency of thermal desorption. In general, middle-range temperatures of 540–650 °C can decrease the concentration of the residual mercury to levels below 2 mg/kg and the mercury can be reclaimed with a purity of 99 %, despite its different structures and forms [252, Chang and Hen 2006].

At a mercury cell chlor-alkali site in Bohus (Sweden), approximately 25 kt of soil contaminated with mercury and PCDDs/PCDFs was planned to be treated in the period from 2000 to 2003. Thermal desorption was planned to take place in a rotary kiln, using a vacuum at a capacity of 2 t/h. The mercury contained in the waste gases (10 mg/m³) was then supposed to enter a wet scrubber containing hydrogen peroxide which oxidises elemental mercury for its precipitation as mercury sulphide [197, Götaverken Miljö 2000].

At a mercury and diaphragm cell chlor-alkali site in Taipei (Taiwan), a full-scale test with a total of 4 174 m³ soil was carried out in 2001 to 2003. Two sets of thermal desorption kilns were used with batch masses of 2 t per kiln and a capacity of 8 t/d per kiln. Optimised performance occurred at a temperature of 750 °C and a residence time of 3 h. The post-treatment system mainly consisted of a condenser, a condensation water tank, a buffer tank and a sulphur-impregnated activated carbon tank (Figure 4.11) [252, Chang and Hen 2006].

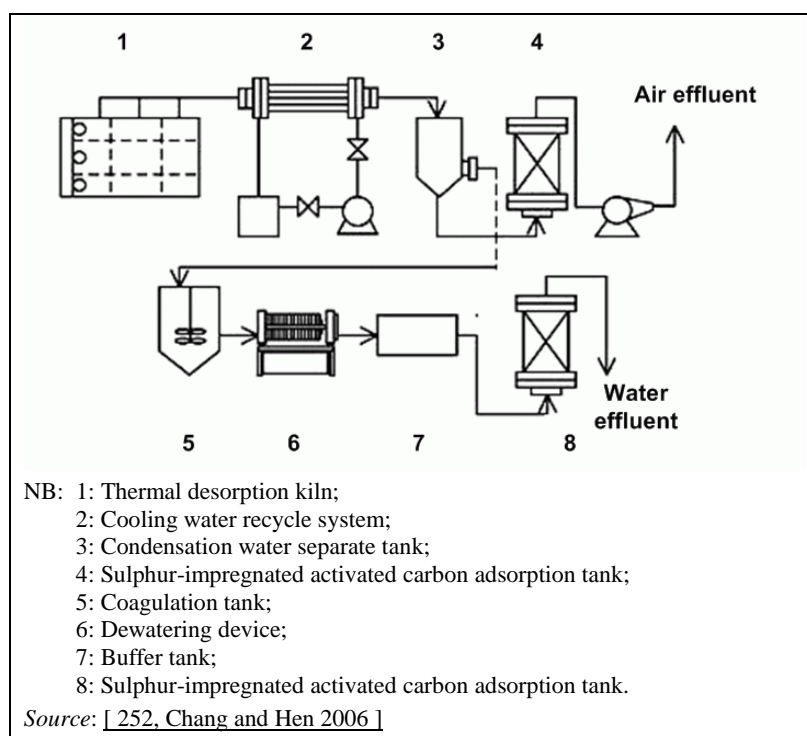

Figure 4.11: Flow diagram of the on-site thermal desorption system used at a chlor-alkali site in Taipei (Taiwan)

At this site, mercury concentrations ranged from 0.76 to 124 mg/kg in surface soil (0–15 cm deep) and from 0.37 to 74.6 mg/kg in subsurface soils (15–30 cm deep). At optimum operating conditions, the mercury concentrations in treated soil could be reduced to 0.19–0.94 mg/kg, with removal efficiencies ranging from 96.1 to 99.8 % [252, Chang and Hen 2006].

In the United States, two full-scale decontaminations were carried out in 1995 at an industrial landfill and a pesticide manufacturing site with 80 kt and 26 kt of soil, respectively. After thermal desorption, total mercury concentrations were less than 1 mg/kg at the industrial landfill and less than 0.12 mg/kg at the pesticide manufacturing site [266, US EPA 2007].

Cross-media effects

Some raw materials and energy are consumed for the construction of the desorption system. Considerable amounts of energy are consumed for the soil heating.

Additional emissions may result from the mobilisation of pollutants, which then have negative effects on health and safety. Any recovered metallic mercury or waste contaminated with mercury from the treatment of waste gases and waste water requires further treatment and/or safe disposal.

Soil properties, such as the leaching potential, could be negatively altered at high temperatures, so soil reuse could become problematic.

Technical considerations relevant to applicability

Thermal desorption requires the excavation of soil, which may be restricted by existing buildings and underground equipment.

Economics

The costs of thermal desorption are highly application-specific and depend on the type and scale of the system, the quantity of soil to be treated, the soil's geotechnical properties, regulatory requirements, the soil's moisture content, the concentration of mercury, and the soil clean-up criteria [252, Chang and Hen 2006].

For the aforementioned thermal desorption system in Taipei (Taiwan), overall costs amounted to USD 3.6 million, with unit costs of USD 834/m³ (equivalent to overall costs of EUR 3.3 million and to unit costs of EUR 754/m³; currency conversion date May 2002; EUR/USD = 0.9038). Construction costs amounted to approximately 38 % of the total costs, operating costs to approximately 56 %, and system decommissioning costs to approximately 6 % [252, Chang and Hen 2006].

Due to the excavation and heating, costs for thermal desorption are generally higher than for *in situ* techniques or other *ex situ* techniques, such as soil washing.

Driving force for implementation

The driving force for implementation of this technique is environmental legislation.

Example plants

- EKA mercury cell chlor-alkali site in Bohus (Sweden), in operation from 1924 to 2005, chlorine capacity 100 kt/yr;
- Mercury and diaphragm cell plant in Taipei (Taiwan), in operation from 1944 to 1985, capacity unknown [252, Chang and Hen 2006];
- Several full-scale and pilot applications in the United States [266, US EPA 2007].

Reference Literature

[197, Götaverken Miljö 2000], [245, Euro Chlor 2012], [252, Chang and Hen 2006], [263, Khrapunov et al. 2007], [266, US EPA 2007]

4.4.4.3 Soil washing

Description

This technique consists in mixing contaminated soil with water and subsequently separating the fine particle fraction to which the mercury is attached. Elemental mercury is also separated from the bulk of the soil.

Technical description

A summary description is provided in Table 4.33. Prior to washing, the soil is typically screened to remove oversized particles and then homogenised. The soil is then mixed with a wash solution of water or water enhanced with chemical additives, such as leaching agents, surfactants, acids, or chelating agents, to help remove organic compounds and heavy metals. Particles are separated by size (cyclone or gravity separation, depending on the type of contaminants in the soil and the particle size), concentrating the contaminants in the fine particle fraction, which then requires further treatment. The coarser-grained soil is relatively clean, usually requiring no additional treatment. Wash water from the process is treated and either reused in the process or disposed of (Figure 4.12) [266, US EPA 2007].

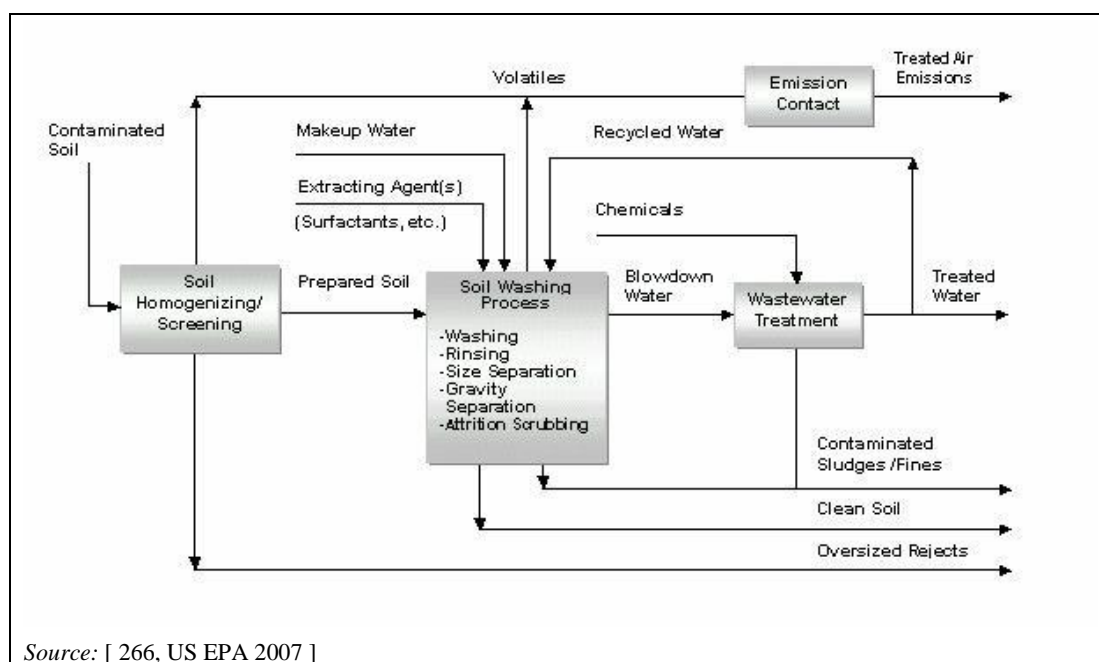

Figure 4.12: Flow diagram of a soil washing system

Achieved environmental benefits

The achieved environmental benefit of this technique is the decontamination of soil.

Environmental performance and operational data

At the Orica chlor-alkali plant in Sydney (Australia), soil washing trials were carried out in 2008 and a full-scale system was put into operation in May 2011. The washing included five steps:

1. screening to remove coarse material (diameter > 10 cm);
2. washing with water to remove particles and elemental mercury droplets with diameters > 6 mm;
3. processing of the aqueous fraction from step 2 in a rotary separator with removal of the elemental mercury;
4. screening of the remaining material through two sieves ('sand' 0.18–6 mm and 'silt' 0.04–0.18 mm);
5. dewatering of slurry from step 4 in a centrifuge.

However, the soil washing plant was not able to sustain adequate reliable operations and Orica decided to suspend the operations in 2011 [247, Orica 2011].

At a mercury cell chlor-alkali site in Squamish, British Columbia (Canada), a total of 150 kt of mercury-contaminated soil and sludge were excavated from 1999 to 2003. While the heavily contaminated soil was stabilised and shipped for disposal, the less severely contaminated soil was washed on site and reused as backfill [264, British Columbia Ministry 2009].

In the United States, a full-scale decontamination was carried out in 1993 at a waste processing and recycling facility with approximately 10 000 m³ of soil. The washing consisted of screening, separation and froth flotation. The concentrations of mercury were reduced from 100 mg/kg to 1 mg/kg [266, US EPA 2007].

Cross-media effects

Some raw materials and energy are consumed for the construction and operation of the washing system.

Additional emissions may result from the mobilisation of pollutants, which then have negative effects on health and safety. Washing implies generating a contaminated waste water stream that has to be treated. Any recovered metallic mercury or waste contaminated with mercury from the treatment of waste gases and waste water requires further treatment and/or safe disposal.

Technical considerations relevant to applicability

Soil washing requires the excavation of soil, which may be restricted by existing buildings and underground equipment.

Economics

No information provided.

Driving force for implementation

The driving force for implementation of this technique is environmental legislation.

Example plants

- Orica mercury cell chlor-alkali site in Sydney (Australia) [247, Orica 2011];
- Nexen mercury cell chlor-alkali site in Squamish, British Columbia (Canada); in operation from 1960 to 1991, capacity unknown [264, British Columbia Ministry 2009];
- Several full-scale and pilot applications in the United States [266, US EPA 2007].

Reference literature

[247, Orica 2011], [264, British Columbia Ministry 2009], [266, US EPA 2007]

5 BEST AVAILABLE TECHNIQUES (BAT) CONCLUSIONS

Scope

These BAT conclusions cover certain industrial activities specified in Sections 4.2(a) and 4.2(c) of Annex I to Directive 2010/75/EU, namely the production of chlor-alkali chemicals (chlorine, hydrogen, potassium hydroxide and sodium hydroxide) by the electrolysis of brine.

In particular, these BAT conclusions cover the following processes and activities:

- the storage of salt;
- the preparation, purification and resaturation of brine;
- the electrolysis of brine;
- the concentration, purification, storage and handling of sodium/potassium hydroxide;
- the cooling, drying, purification, compression, liquefaction, storage and handling of chlorine;
- the cooling, purification, compression, storage and handling of hydrogen;
- the conversion of mercury cell plants to membrane cell plants;
- the decommissioning of mercury cell plants;
- the remediation of chlor-alkali production sites.

These BAT conclusions do not address the following activities or processes:

- the electrolysis of hydrochloric acid for the production of chlorine;
- the electrolysis of brine for the production of sodium chlorate; this is covered by the BAT reference document on Large Volume Inorganic Chemicals – Solids and Others Industry (LVIC-S);
- the electrolysis of molten salts for the production of alkali or alkaline earth metals and chlorine; this is covered by the BAT reference document on Non-ferrous Metals Industries (NFM);
- the production of specialities such as alcoholates, dithionites and alkali metals by using alkali metal amalgam produced with the mercury cell technique;
- the production of chlorine, hydrogen or sodium/potassium hydroxide by processes other than electrolysis.

These BAT conclusions do not address the following aspects of chlor-alkali production as they are covered by the BAT reference document on Common Waste Water and Waste Gas Treatment/Management Systems in the Chemical Sector (CWW):

- the treatment of waste water in a downstream treatment plant;
- environmental management systems;
- noise emissions.

Other reference documents which are of relevance for the activities covered by these BAT conclusions are the following:

Reference document	Subject
Common Waste Water and Waste Gas Treatment/Management Systems in the Chemical Sector BREF (CWW)	Common waste water and waste gas treatment/management systems
Economics and Cross-Media Effects (ECM)	Economics and cross-media effects of techniques
Emissions from Storage (EFS)	Storage and handling of materials
Energy Efficiency (ENE)	General aspects of energy efficiency
Industrial Cooling Systems (ICS)	Indirect cooling with water
Large Combustion Plants (LCP)	Combustion plants with a rated thermal input of 50 MW or more
General Principles of Monitoring (MON)	General aspects of emissions and consumption monitoring
Waste Incineration (WI)	Waste incineration
Waste Treatments Industries (WT)	Waste treatment

General considerations

The techniques listed and described in these BAT conclusions are neither prescriptive nor exhaustive. Other techniques may be used that ensure at least an equivalent level of environmental protection.

Unless otherwise stated, the BAT conclusions are generally applicable.

Emission levels associated with the best available techniques (BAT-AELs) for emissions to air given in these BAT conclusions refer to:

- concentration levels expressed as mass of emitted substances per volume of waste gas under standard conditions (273.15 K, 101.3 kPa), after deduction of the water content but without correction of the oxygen content, with the unit mg/m³;

BAT-AELs for emissions to water given in these BAT conclusions refer to:

- concentration levels expressed as mass of emitted substances per volume of waste water, with the unit mg/l.

Definitions

For the purposes of these BAT conclusions, the following definitions apply:

Term used	Definition
New plant	A plant first operated at the installation following the publication of these BAT conclusions or a complete replacement of a plant on the existing foundations of the installation following the publication of these BAT conclusions.
Existing plant	A plant which is not a new plant.
New chlorine liquefaction unit	A chlorine liquefaction unit first operated at the plant following the publication of these BAT conclusions or a complete replacement of a chlorine liquefaction unit following the publication of these BAT conclusions.
Chlorine and chlorine dioxide, expressed as Cl ₂	The sum of chlorine (Cl ₂) and chlorine dioxide (ClO ₂), measured together and expressed as Cl ₂ .
Free chlorine, expressed as Cl ₂	The sum of dissolved elementary chlorine, hypochlorite, hypochlorous acid, dissolved elementary bromine, hypobromite, and hypobromic acid, measured together and expressed as Cl ₂ .
Mercury, expressed as Hg	The sum of all inorganic and organic mercury species, measured together and expressed as Hg.

BAT conclusions

5.1 Cell technique

BAT 1. BAT for the production of chlor-alkali is to use one or a combination of the techniques given below. The mercury cell technique cannot be considered BAT under any circumstances. The use of asbestos diaphragms is not BAT.

	Technique	Description	Applicability
a	Bipolar membrane cell technique	Membrane cells consist of an anode and a cathode separated by a membrane. In a bipolar configuration, individual membrane cells are electrically connected in series.	Generally applicable.
b	Monopolar membrane cell technique	Membrane cells consist of an anode and a cathode separated by a membrane. In a monopolar configuration, individual membrane cells are electrically connected in parallel.	Not applicable to new plants with a chlorine capacity of > 20 kt/yr.
c	Asbestos-free diaphragm cell technique	Asbestos-free diaphragm cells consist of an anode and a cathode separated by an asbestos-free diaphragm. Individual diaphragm cells are electrically connected in series (bipolar) or in parallel (monopolar).	Generally applicable.

5.2 Decommissioning or conversion of mercury cell plants

BAT 2. In order to reduce emissions of mercury and to reduce the generation of waste contaminated with mercury during the decommissioning or conversion of mercury cell plants, BAT is to elaborate and implement a decommissioning plan that incorporates all of the following features:

- (i.) inclusion of some of the staff experienced in running the former plant at all stages of elaboration and implementation;
- (ii.) provision of procedures and instructions for all stages of implementation;
- (iii.) provision of a detailed training and supervision programme for personnel with no experience in mercury handling;
- (iv.) determination of the quantity of metallic mercury to be recovered and estimation of the quantity of waste to be disposed of and of the mercury contamination contained therein;
- (v.) provision of working areas which are:
 - (a) covered with a roof;
 - (b) equipped with a smooth, sloped, impervious floor to direct mercury spills to a collection sump;
 - (c) well lit;
 - (d) free of obstructions and debris that may absorb mercury;
 - (e) equipped with a water supply for washing;
 - (f) connected to a waste water treatment system;
- (vi.) emptying of the cells and transfer of metallic mercury to containers by:
 - (a) keeping the system closed, if possible;
 - (b) washing of mercury;
 - (c) using gravity transfer, if possible;
 - (d) removing solid impurities from mercury, if necessary;
 - (e) filling the containers to $\leq 80\%$ of their volumetric capacity;
 - (f) hermetically sealing the containers after filling;
 - (g) washing of the empty cells, followed by filling with water;
- (vii.) carrying out of all dismantling and demolition operations by:
 - (a) replacing hot cutting of equipment by cold cutting, if possible;
 - (b) storing contaminated equipment in suitable areas;
 - (c) frequent washing of the floor of the working area;
 - (d) rapid clean-up of mercury spills by using aspiration equipment with activated carbon filters;
 - (e) accounting of waste streams;
 - (f) separating mercury-contaminated waste from non-contaminated waste;
 - (g) decontaminating waste contaminated with mercury by using mechanical and physical treatment techniques (e.g. washing, ultrasonic vibration, vacuum cleaners), chemical treatment techniques (e.g. washing with hypochlorite, chlorinated brine or hydrogen peroxide) and/or thermal treatment techniques (e.g. distillation/retorting);
 - (h) reusing or recycling decontaminated equipment, if possible;
 - (i) decontaminating the cell room building by cleaning the walls and the floor, followed by coating or painting to give them an impermeable surface if the building is to be reused;
 - (j) decontaminating or renewing the waste water collection systems in or around the plant;
 - (k) confining the working area and treating ventilation air when high concentrations of mercury are expected (e.g. for high-pressure washing); treatment techniques

for ventilation air include adsorption on iodised or sulphurised activated carbon, scrubbing with hypochlorite or chlorinated brine or adding chlorine to form solid dimercury dichloride;

- (l) treating mercury-containing waste water, including laundry wash water arising from the cleaning of protective equipment;
- (m) monitoring of mercury in air, water and waste, including for an appropriate time after the finalisation of the decommissioning or conversion;

(viii.) if needed, interim storage of metallic mercury on site in storage facilities that are:

- (a) well lit and weatherproof;
- (b) equipped with a suitable secondary containment capable of retaining 110 % of the liquid volume of any single container;
- (c) free of obstructions and debris that may absorb mercury;
- (d) equipped with aspiration equipment with activated carbon filters;
- (e) periodically inspected, both visually and with mercury-monitoring equipment;

(ix.) if needed, transport, potential further treatment and disposal of waste.

BAT 3. In order to reduce emissions of mercury to water during the decommissioning or conversion of mercury cell plants, BAT is to use one or a combination of the techniques given below.

	Technique	Description
a	Oxidation and ion exchange	Oxidising agents such as hypochlorite, chlorine or hydrogen peroxide are used to fully convert mercury into its oxidised form, which is subsequently removed by ion-exchange resins.
b	Oxidation and precipitation	Oxidising agents such as hypochlorite, chlorine or hydrogen peroxide are used to fully convert mercury into its oxidised form, which is subsequently removed by precipitation as mercury sulphide, followed by filtration.
c	Reduction and adsorption on activated carbon	Reducing agents such as hydroxylamine are used to fully convert mercury into its elemental form, which is subsequently removed by coalescence and recovery of metallic mercury, followed by adsorption on activated carbon.

The **BAT-associated environmental performance level** ⁽¹⁾ for mercury emissions to water, expressed as Hg, at the outlet of the mercury treatment unit during decommissioning or conversion is 3–15 µg/l in 24-hour flow-proportional composite samples taken daily. The associated monitoring is described in BAT 7.

⁽¹⁾ Given that this performance level does not relate to normal operating conditions, it is not an emission level associated with the Best Available Techniques in the sense of Article 3(13) of the Industrial Emissions Directive (2010/75/EU).

5.3 Generation of waste water

BAT 4. In order to reduce the generation of waste water, BAT is to use a combination of the techniques given below.

	Technique	Description	Applicability
a	Brine recirculation	The depleted brine from the electrolysis cells is resaturated with solid salt or by evaporation and fed back to the cells.	Not applicable to diaphragm cell plants. Not applicable to membrane cell plants using solution-mined brine when abundant salt and water resources and a saline receiving water body, which tolerates high chloride emission levels, are available. Not applicable to membrane cell plants using the brine purge in other production units.
b	Recycling of other process streams	Process streams from the chlor-alkali plant such as condensates from chlorine, sodium/potassium hydroxide and hydrogen processing are fed back to various steps of the process. The degree of recycling is limited by the purity requirements of the liquid stream to which the process stream is recycled and the water balance of the plant.	Generally applicable.
c	Recycling of salt-containing waste water from other production processes	Salt-containing waste water from other production processes is treated and fed back into the brine system. The degree of recycling is limited by the purity requirements of the brine system and the water balance of the plant.	Not applicable to plants where an additional treatment of this waste water offsets the environmental benefits.
d	Use of waste water for solution mining	Waste water from the chlor-alkali plant is treated and pumped back to the salt mine.	Not applicable to membrane cell plants using the brine purge in other production units. Not applicable if the mine is located at a significantly higher altitude than the plant.
e	Concentration of brine filtration sludges	Brine filtration sludges are concentrated in filter presses, rotary drum vacuum filters or centrifuges. The residual water is fed back into the brine system.	Not applicable if the brine filtration sludges can be removed as dry cake. Not applicable to plants that reuse waste water for solution mining.
f	Nanofiltration	A specific type of membrane filtration with membrane pore sizes of approximately 1 nm, used to concentrate sulphate in the brine purge, thereby reducing the waste water volume.	Applicable to membrane cell plants with brine recirculation, if the brine purge rate is determined by the sulphate concentration.
g	Techniques to reduce chlorate emissions	Techniques to reduce chlorate emissions are described in BAT 14. These techniques reduce the brine purge volume.	Applicable to membrane cell plants with brine recirculation, if the brine purge rate is determined by the chlorate concentration.

5.4 Energy efficiency

BAT 5. In order to use energy efficiently in the electrolysis process, BAT is to use a combination of the techniques given below.

	Technique	Description	Applicability
a	High-performance membranes	High-performance membranes show low voltage drops and high current efficiencies while ensuring mechanical and chemical stability under the given operating conditions.	Applicable to membrane cell plants when renewing membranes at the end of their lifetime.
b	Asbestos-free diaphragms	Asbestos-free diaphragms consist of a fluorocarbon polymer and fillers such as zirconium dioxide. These diaphragms show lower resistance overpotentials than asbestos diaphragms.	Generally applicable.
c	High-performance electrodes and coatings	Electrodes and coatings with improved gas release (low gas bubble overpotential) and low electrode overpotentials.	Applicable when renewing coatings at the end of their lifetime.
d	High-purity brine	The brine is sufficiently purified to minimise contamination of the electrodes and diaphragms/membranes, which could otherwise increase energy consumption.	Generally applicable.

BAT 6. In order to use energy efficiently, BAT is to maximise the use of the co-produced hydrogen from the electrolysis as a chemical reagent or fuel.

Description

Hydrogen can be used in chemical reactions (e.g. production of ammonia, hydrogen peroxide, hydrochloric acid, and methanol; reduction of organic compounds; hydrodesulphurisation of petroleum; hydrogenation of oils and greases; chain termination in polyolefin production) or as a fuel in a combustion process to produce steam and/or electricity or to heat a furnace. The degree to which hydrogen is used depends on a number of factors (e.g. demand for hydrogen as reagent on the site, demand for steam on the site, distance to potential users).

5.5 Monitoring of emissions

BAT 7. BAT is to monitor emissions to air and water by using monitoring techniques in accordance with EN standards with at least the minimum frequency given below. If EN standards are not available, BAT is to use ISO, national or other international standards that ensure the provision of data of an equivalent scientific quality.

Environmental medium	Substance(s)	Sampling point	Method	Standard(s)	Minimum monitoring frequency	Monitoring associated with
Air	Chlorine and chlorine dioxide, expressed as Cl ₂ ⁽¹⁾	Outlet of chlorine absorption unit	Electrochemical cells	No EN or ISO standard available	Continuous	—
			Absorption in a solution, with subsequent analysis	No EN or ISO standard available	Yearly (at least three consecutive hourly measurements)	BAT 8
Water	Chlorate	Where the emission leaves the installation	Ion chromatography	EN ISO 10304-4	Monthly	BAT 14
	Chloride	Brine purge	Ion chromatography or flow analysis	EN ISO 10304-1 or EN ISO 15682	Monthly	BAT 12
	Free chlorine ⁽¹⁾	Close to the source	Reduction potential	No EN or ISO standard available	Continuous	—
		Where the emission leaves the installation	Free chlorine	EN ISO 7393-1 or -2	Monthly	BAT 13
	Halogenated organic compounds	Brine purge	Adsorbable organically bound halogens (AOX)	Annex A to EN ISO 9562	Yearly	BAT 15
	Mercury	Outlet of the mercury treatment unit	Atomic absorption spectrometry or atomic fluorescence spectrometry	EN ISO 12846 or EN ISO 17852	Daily	BAT 3
	Sulphate	Brine purge	Ion chromatography	EN ISO 10304-1	Yearly	—
	Relevant heavy metals (e.g. nickel, copper)	Brine purge	Inductively coupled plasma optical emission spectrometry or inductively coupled plasma mass spectrometry	EN ISO 11885 or EN ISO 17294-2	Yearly	—

⁽¹⁾ Monitoring encompasses both continuous and periodic monitoring as indicated.

5.6 Emissions to air

BAT 8. In order to reduce channelled emissions of chlorine and chlorine dioxide to air from the processing of chlorine, BAT is to design, maintain and operate a chlorine absorption unit that incorporates an appropriate combination of the following features:

- (i.) absorption unit based on packed columns and/or ejectors with an alkaline solution (e.g. sodium hydroxide solution) as scrubbing liquid;
- (ii.) hydrogen peroxide dosing equipment or a separate wet scrubber with hydrogen peroxide if necessary to reduce chlorine dioxide concentrations;
- (iii.) size suitable for the worst case scenario (derived from a risk assessment), in terms of produced chlorine quantity and flowrate (absorption of the full cell room production for a sufficient duration until the plant is shut down);
- (iv.) size of the scrubbing liquid supply and storage capacity suitable to ensure an excess at all times;
- (v.) in the case of packed columns, their size should be suitable to prevent flooding at all times;
- (vi.) prevention of ingress of liquid chlorine into the absorption unit;
- (vii.) prevention of backflow of scrubbing liquid into the chlorine system;
- (viii.) prevention of solids precipitation in the absorption unit;
- (ix.) use of heat exchangers to limit the temperature in the absorption unit below 55 °C at all times;
- (x.) supply of dilution air after chlorine absorption to prevent the formation of explosive gas mixtures;
- (xi.) use of construction materials which withstand the extremely corrosive conditions at all times;
- (xii.) use of backup equipment, such as an additional scrubber in series with the one in operation, an emergency tank with scrubbing liquid feeding the scrubber by gravity, standby and spare fans, standby and spare pumps;
- (xiii.) provision of an independent backup system for critical electrical equipment;
- (xiv.) provision of an automatic switch to the backup system in case of emergencies, including periodic tests on this system and the switch;
- (xv.) provision of a monitoring and alarm system for the following parameters:
 - (a) chlorine in the outlet of the absorption unit and the surrounding area;
 - (b) temperature of the scrubbing liquids;
 - (c) reduction potential and alkalinity of the scrubbing liquids;
 - (d) suction pressure;
 - (e) flowrate of scrubbing liquids.

The **BAT-associated emission level** for chlorine and chlorine dioxide, measured together and expressed as Cl₂, is 0.2–1.0 mg/m³, as an average value of at least three consecutive hourly measurements performed at least once every year at the outlet of the chlorine absorption unit. The associated monitoring is described in BAT 7.

BAT 9. The use of carbon tetrachloride for the elimination of nitrogen trichloride or the recovery of chlorine from tail gas is not BAT.

BAT 10. The use of refrigerants with a high global warming potential, and in any case higher than 150 (e.g. many hydrofluorocarbons (HFCs)), in new chlorine liquefaction units cannot be considered BAT.

Description

Suitable refrigerants include, for example:

- a combination of carbon dioxide and ammonia in two cooling circuits;
- chlorine;
- water.

Applicability

The refrigerant section should take into account operational safety and energy efficiency.

5.7 Emissions to water

BAT 11. In order to reduce emissions of pollutants to water, BAT is to use an appropriate combination of the techniques given below.

	Technique	Description
a	Process-integrated techniques ⁽¹⁾	Techniques that prevent or reduce the generation of pollutants
b	Waste water treatment at source ⁽¹⁾	Techniques to abate or recover pollutants prior to their discharge to the waste water collection system
c	Waste water pretreatment ⁽²⁾	Techniques to abate pollutants before the final waste water treatment
d	Final waste water treatment ⁽²⁾	Final waste water treatment by mechanical, physico-chemical and/or biological techniques before discharge to a receiving water body
⁽¹⁾ Covered by BAT 1, 4, 12, 13, 14 and 15. ⁽²⁾ Within the scope of the BAT reference document on Common Waste Water and Waste Gas Treatment/Management Systems in the Chemical Sector (CWW BREF).		

BAT 12. In order to reduce emissions of chloride to water from the chlor-alkali plant, BAT is to use a combination of the techniques given in BAT 4.

BAT 13. In order to reduce emissions of free chlorine to water from the chlor-alkali plant, BAT is to treat waste water streams containing free chlorine as close as possible to the source, to prevent stripping of chlorine and/or the formation of halogenated organic compounds, by using one or a combination of the techniques given below.

	Technique	Description
a	Chemical reduction	The free chlorine is destroyed by reaction with reducing agents, such as sulphite and hydrogen peroxide, in stirred tanks.
b	Catalytic decomposition	The free chlorine is decomposed to chloride and oxygen in catalytic fixed-bed reactors. The catalyst can be a nickel oxide promoted with iron on an alumina support.
c	Thermal decomposition	The free chlorine is converted to chloride and chlorate by thermal decomposition at approximately 70 °C. The resulting effluent requires further treatment to reduce emissions of chlorate and bromate (BAT 14).
d	Acidic decomposition	The free chlorine is decomposed by acidification, with a subsequent release and recovery of chlorine. Acidic decomposition can be carried out in a separate reactor or by recycling of the waste water to the brine system. The degree of recycling of waste water to the brine circuit is restricted by the water balance of the plant.
e	Waste water recycling	Waste water streams of the chlor-alkali plant are recycled to other production units.

The BAT-associated emission level for free chlorine, expressed as Cl₂, is 0.05–0.2 mg/l in spot samples taken at least once every month at the point where the emission leaves the installation. The associated monitoring is described in BAT 7.

BAT 14. In order to reduce emissions of chlorate to water from the chlor-alkali plant, BAT is to use one or a combination of the techniques given below.

	Technique	Description	Applicability
a	High-performance membranes	Membranes showing high current efficiencies, that reduce chlorate formation while ensuring mechanical and chemical stability under the given operating conditions.	Applicable to membrane cell plants when renewing membranes at the end of their lifetime.
b	High-performance coatings	Coatings with low electrode overpotentials leading to reduced chlorate formation and increased oxygen formation at the anode.	Applicable when renewing coatings at the end of their lifetime. The applicability may be restricted by the quality requirements of the produced chlorine (oxygen concentration).
c	High-purity brine	The brine is sufficiently purified to minimise contamination of electrodes and diaphragms/membranes, which could otherwise increase the formation of chlorate.	Generally applicable.
d	Brine acidification	The brine is acidified prior to electrolysis, in order to reduce the formation of chlorate. The degree of acidification is limited by the resistivity of the equipment used (e.g. membranes and anodes).	Generally applicable.
e	Acidic reduction	Chlorate is reduced with hydrochloric acid at pH values of 0 and at temperatures higher than 85 °C.	Not applicable to once-through brine plants.
f	Catalytic reduction	In a pressurised trickle-bed reactor, chlorate is reduced to chloride by using hydrogen and a rhodium catalyst in a three-phase reaction.	Not applicable to once-through brine plants.
g	Use of waste water streams containing chlorate in other production units	The waste water streams from the chlor-alkali plant are recycled to other production units, most typically to the brine system of a sodium chlorate production unit.	Restricted to sites that can make use of waste water streams of this quality in other production units.

BAT 15. In order to reduce emissions of halogenated organic compounds to water from the chlor-alkali plant, BAT is to use a combination of the techniques given below.

	Technique	Description
a	Selection and control of salt and ancillary materials	Salt and ancillary materials are selected and controlled to reduce the level of organic contaminants in the brine.
b	Water purification	Techniques such as membrane filtration, ion exchange, UV irradiation and adsorption on activated carbon can be used to purify process water, thereby reducing the level of organic contaminants in the brine.
c	Selection and control of equipment	Equipment, such as cells, tubes, valves and pumps, is carefully selected to reduce the potential leaching of organic contaminants into the brine.

5.8 Generation of waste

BAT 16. In order to reduce the quantity of spent sulphuric acid sent for disposal, BAT is to use one or a combination of the techniques given below. The neutralisation of spent sulphuric acid from chlorine drying with virgin reagents is not BAT.

	Technique	Description	Applicability
a	Use on site or off site	The spent acid is used for other purposes, such as to control the pH in process and waste water, or to destroy surplus hypochlorite.	Applicable to sites with an on-site or off-site demand for spent acid of this quality.
b	Reconcentration	The spent acid is reconcentrated on site or off site in closed-loop evaporators under vacuum by indirect heating or by strengthening using sulphur trioxide.	Off-site reconcentration is restricted to sites where a service provider is located nearby.

The **BAT-associated environmental performance level** for the quantity of spent sulphuric acid sent for disposal, expressed as H₂SO₄ (96 wt-%), is ≤ 0.1 kg per tonne of chlorine produced.

5.9 Site remediation

BAT 17. In order to reduce contamination of soil, groundwater and air, as well as to halt pollutant dispersion and transfer to biota from contaminated chlor-alkali sites, BAT is to devise and implement a site remediation plan that incorporates all of the following features:

- (i.) implementation of emergency techniques to cut off the exposure pathways and the expansion of the contamination;
- (ii.) desk study to identify the origin, extent and composition of the contamination (e.g. mercury, PCDDs/PCDFs, polychlorinated naphthalenes);
- (iii.) characterisation of the contamination, including surveys and the preparation of a report;
- (iv.) risk assessment over time and space as a function of the current and approved future use of the site;
- (v.) preparation of an engineering project including:
 - (a) decontamination and/or permanent containment;
 - (b) timetables;
 - (c) monitoring plan;
 - (d) financial planning and investment to achieve the target;
- (vi.) implementation of the engineering project so that the site, taking into account its current and approved future use, no longer poses any significant risk to human health or the environment. Depending on other obligations, the engineering project might have to be implemented in a more stringent manner;
- (vii.) site use restrictions if necessary due to residual contamination and taking into account the current and approved future use of the site;
- (viii.) associated monitoring at the site and in the surrounding areas to verify that the objectives are achieved and maintained.

Description

A site remediation plan is often devised and implemented after taking the decision to decommission the plant, although other requirements may dictate a (partial) site remediation plan while the plant is still in operation.

Some features of the site remediation plan can overlap, be skipped, or be carried out in another order, depending on other requirements.

Applicability

The applicability of BAT 17(v) to 17(viii) is subject to the results of the risk assessment mentioned under BAT 17(iv).

Glossary

Anode	Electrode through which electric current flows into a polarised electrical device. The polarity can be positive or negative. In electrolytic cells, oxidation occurs at the positively charged anode.
Asbestos	Set of six naturally occurring silicate minerals exploited commercially for their desirable physical properties. Chrysotile (also called white asbestos) is the only form of asbestos used in diaphragm cell plants..
Brine	Solution saturated or nearly saturated sodium chloride or potassium chloride.
Cathode	Electrode through which electric current flows out of a polarised electrical device. The polarity can be positive or negative. In electrolytic cells, reduction occurs at the negatively charged cathode.
Electrode	Electrical conductor used to make contact with a non-metallic part of an electric circuit.
Electrolysis	Passage of a direct electric current through an ionic substance, resulting in chemical reactions at the electrodes. The ionic substance is either molten or dissolved in a suitable solvent.
EN	European Standard adopted by CEN (European Committee for Standardisation).
HFC	Hydrofluorocarbon.
ISO	International Organisation for Standardisation or standard adopted by this organisation.
Overpotential	Voltage difference between a half-reaction's thermodynamically determined reduction potential and the potential at which the redox event is experimentally observed. In an electrolytic cell the overpotential leads to the consumption of more energy than thermodynamically expected to drive a reaction.
PCDD	Polychlorinated dibenzo- <i>p</i> -dioxin.
PCDF	Polychlorinated dibenzofuran.

6 EMERGING TECHNIQUES

6.1 Overview

Since the adoption of the first Chlor-alkali Manufacturing Industry BREF in 2001, some techniques which were not described therein have in the meantime been successfully introduced in several installations. This includes the catalytic reduction of chlorate with hydrogen (Section 4.3.6.4) and the removal of sulphate from the brine by nanofiltration (Section 4.3.6.2.2).

Two of the three emerging techniques described in the chlor-alkali BREF from 2001 were not introduced on an industrial scale: the development of sophisticated membranes allowing the direct production of caustic soda at the commercial concentration of 50 wt-% was abandoned in approximately 2000 due to technical problems [49, Euro Chlor 2010]. In addition, the manufacturer reported in 1999 that due to the cell voltage increase (lower conductivity of 50 wt-% NaOH compared to 32 wt-% NaOH, higher electrical resistance of the modified membrane) the technique is economically only feasible if steam costs are comparatively high and electricity costs are comparatively low and that therefore demand was too low for commercialisation [50, Asahi Glass 1999]. The development of built-in precathode diaphragms was also discontinued, mainly due to the availability of commercially proven asbestos-free diaphragms for standard electrolyzers [49, Euro Chlor 2010]. Regarding the third emerging technique, an industrial installation with a chlorine capacity of 20 kt/yr using oxygen-depolarised cathodes was put into operation in 2011 (Section 6.2).

6.2 Oxygen-depolarised cathodes

Description

This technique consists in replacing the common metal cathodes in membrane cells with oxygen-depolarised cathodes that reduce oxygen to produce hydroxide, instead of converting water to hydrogen and hydroxide.

Technical description

The utilisation of oxygen-depolarised cathodes (ODC) in chlor-alkali electrolysis is an integration of an alkaline fuel cell cathode into the membrane electrolysis cell. This lowers the cell voltage by about 1 V at current densities of industrial relevance (e.g. 4 kA/m²), and thus the electrical energy consumption by about 30 %. A higher reduction of the cell voltage of 1.23 V would be expected from the difference in standard electrode potentials. However, the overpotential of oxygen reduction shows a stronger increase with current density than that of hydrogen formation [49, Euro Chlor 2010], [52, Moussallem et al. 2008].

The cathode reaction in membrane cells with ODC is [52, Moussallem et al. 2008]:

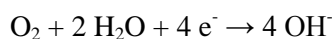

The overall reaction is:

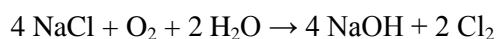

The ODC requires the use of pure oxygen (92–99 %), but research is ongoing on the use of plain or oxygen-enriched air instead of pure oxygen [3, Euro Chlor 2011], [49, Euro Chlor 2010].

The ODC is a gas diffusion electrode where the gas diffuses into the porous electrode structure to the catalyst centres and reacts with the cathodic water to produce OH⁻ ions. The ODC has to meet strict requirements for successful operation [52, Moussallem et al. 2008], [122, Bayer 2012]:

- chemical stability in concentrated sodium hydroxide solution and in the presence of oxygen at temperatures between 80 and 90 °C;
- high mechanical stability in technical electrolyzers with areas of several m²;
- high electrical conductivity and low thickness;
- high surface area and activity of electrocatalyst;
- suitable hydrophobic/hydrophilic pore structure for easy access of gases and liquids without gas passing through and flooding by liquid electrolyte, even at different pressure differences between gas and liquid;
- high long-term stability;
- affordable costs.

These strict requirements explain why it took around forty years from the beginning of research on ODCs in the early seventies to the construction of an industrial installation in 2010. During the 1990s, two large programmes were started by the Japanese Ministry of Trade and Industry in cooperation with the Japanese Soda Industry Association, as well as by Bayer in cooperation with Uhde and DeNora in Germany. In 2011, limited information was available on developments in Japan, but it is known that at least two pilot units have been undergoing tests since 2007 [49, Euro Chlor 2010]. In Germany, the Federal Ministry of Education and Research funded a programme from 2006 to 2010 to render the technique economically viable by reducing the electrolysis voltage to 2.0 V at 4 kA/m² and by reducing ODC production costs [51, Bulan 2007], [53, Bulan et al. 2009]. As a result, a membrane cell plant using the ODC technique operated by Bayer and Uhdenora/Uhde with a chlorine capacity of 20 kt/yr was put into operation in summer 2011 [49, Euro Chlor 2010].

Oxygen-depolarised cathodes for chlor-alkali electrolysis can be used in two-compartment, zero-gap cells or in three-compartment, finite-gap cells. In zero-gap cells, the ODC is in direct contact with the membrane. Gaseous oxygen and liquid electrolyte flow countercurrently through the electrode. This design has two potential advantages. Firstly, the problem of height-dependent pressure difference is solved (see below) and secondly, the ohmic losses in the catholyte gap are minimised. On the other hand, oxygen transport may be hindered, as the produced sodium hydroxide flows in the opposite direction. In addition, the sodium ions do not carry enough water through the membrane, leading to very high caustic concentrations that may damage the membrane. This problem can be overcome by adding water to the oxygen feed, by using more stable membranes, or by adjusting the brine concentration [52, Moussallem et al. 2008], [122, Bayer 2012].

The only existing plant on an industrial scale is based on three-compartment, finite-gap cells (Figure 6.1).

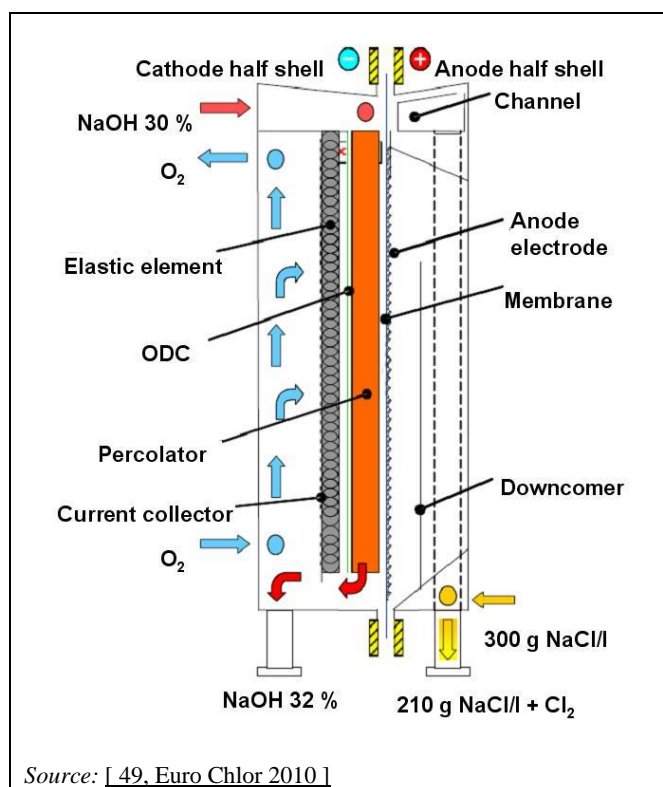

Figure 6.1: Schematic view of a three-compartment, finite-gap membrane cell with an oxygen-depolarised cathode (Bayer/Uhde design)

As in usual membrane cell operation, weak caustic soda is introduced into the cathode chamber, where it is enriched. However, differing from conventional membrane cells, the feed caustic is introduced at the top, into the gap between the membrane and the ODC. The gap is filled with a cloth called a 'percolator', which reduces the flow velocity of the caustic. Due to the 'free'-falling caustic film, there is no, or only very little, hydrostatic pressure in the gap. The ODC is installed as the next layer and is made out of PTFE, noble metals such as silver, and other active elements. The ODC is in contact with the caustic on one side, while oxygen enters the porous structure from the other. The next layers are the 'elastic element' and the 'current collector'. The current flows via this current collector through the elastic element to the ODC. A proper electric contact and even current distribution is reached by gently pressing all pieces together, and is maintained by the elastic element [49, Euro Chlor 2010], [122, Bayer 2012].

The main disadvantage of finite-gap electrolysis cells is that the porous electrodes suffer from the permeation of gas or liquid if the pressure difference between both sides exceeds a certain

value. Industrial electrodes are usually higher than 1 m, resulting in a hydraulic pressure difference between the bottom and the top of approximately 0.2 bar, while the gas pressure remains constant. This normally limits the active height to some 20–30 cm. Three different concepts have been described to overcome this problem [52, Moussallem et al. 2008], [122, Bayer 2012].

The first concept is the use of the 'falling film electrolysis cell' as shown in Figure 6.1. In these falling film cells, the hydrostatic pressure is compensated by an equally high counteracted hydrodynamic pressure drop. As a result, the pressure difference between the electrolyte and the gas on the other side of the ODC remains constant over the whole height of the vertical electrode. The falling film concept allows for a very small electrolyte gap of less than 1 mm between the membrane and the ODC. In some cases, a porous material made of metals, metal oxides or polymers is included in the cathodic compartment of a falling film electrolyser [52, Moussallem et al. 2008].

The second concept uses compartments on the oxygen side, the pressure of which can be independently adjusted. The height of these compartments is sufficiently low to prevent electrode flooding or gas permeation. This concept was successfully applied by Bayer and Uhde/Uhdenora on a pilot scale in an electrolyser with a 2.5 m² electrode area and 16 bipolar elements, but was later discontinued.

The third concept relies on the use of electrolysis cells with horizontally disposed electrodes, but this has not yet been tested on a technical scale [52, Moussallem et al. 2008].

Achieved environmental benefits

The achieved environmental benefit of this technique is a reduction of energy consumption.

Environmental performance and operational data

In the Uhde test unit at the Bayer MaterialScience site in Leverkusen, the standardised electrolyser's electricity consumption at 4 kA/m² was confirmed to be lower than 1600 kWh/t Cl₂ produced, which is equivalent to a reduction of electrical energy consumption of approximately 30 %. The electrolysis voltage could be decreased to 2.0 V [49, Euro Chlor 2010], [53, Bulan et al. 2009].

However, the overall reduction of energy consumption is lower, as some energy is required to produce pure oxygen and because hydrogen is not co-produced, which could otherwise be used in chemical reactions or to produce steam and electricity via combustion or fuel cells [49, Euro Chlor 2010]. The aforementioned research project, funded by the German Federal Ministry of Education and Research, came to the conclusion that an overall reduction of energy consumption of approximately 15 % can be expected when a modern membrane cell plant is converted to the ODC technique, and when the hydrogen is produced via steam reforming. Energy savings are expected to be significantly higher when older installations are converted or when hydrogen is not used for chemical reactions [53, Bulan et al. 2009].

Cross-media effects

Raw materials and energy are consumed for the manufacture of the ODCs. Furthermore, the production of pure oxygen requires additional equipment and energy. In cases where hydrogen is used in an existing plant for chemical reactions, this hydrogen must be produced by other processes which require additional equipment and energy [49, Euro Chlor 2010], [122, Bayer 2012]. At the end of the lifetime of the cells, the PTFE and the silver catalyst can be recovered, which is not the case for conventional cathodes where the noble metal is lost [53, Bulan et al. 2009], [122, Bayer 2012].

Technical considerations relevant to applicability

The ODC technique can be used in new installations. Since June 2013, the ODC technique has been commercialised by just one manufacturer of electrolyzers. In 2014, a contract was signed for the construction of a new plant in Binzhou, Shandong (China). Half of the total capacity of

this plant is expected to be put into operation in the second semester of 2015. The retrofitting of existing membrane cell plants made by that single manufacturer is also possible, provided that parts of the electrolyzers are adapted. Practical experience with a new plant on an industrial scale and with the retrofitting of existing plants needs to be gained [3, Euro Chlor 2011], [49, Euro Chlor 2010], [333, Euro Chlor 2012], [344, Uhdenora 2014].

Economics

The economic assessment of the ODC technique versus the conventional membrane cell technique depends on a number of factors, such as the costs for electricity, new electrolysis cells, ODCs and required oxygen on the one hand, as well as on the type and degree of hydrogen usage on the other. Moreover, it has to be considered whether a new plant or the conversion of an existing amalgam or diaphragm cell plant is planned. It is therefore difficult to draw general conclusions without taking into account the integration of the ODC technique into the whole plant and site [49, Euro Chlor 2010], [52, Moussallem et al. 2008].

Investment costs for the conversion to the ODC technique were reported to be in the range of EUR 70–100/t annual chlorine capacity. Assuming that the co-produced hydrogen is burnt, that the costs for the production of pure oxygen are EUR 0.054–0.063/m³ (at standard conditions), and that the electricity price is EUR 60/MWh, the ODC technique was reported in 2009 to be economically viable [113, Moussallem et al. 2009]. However, if the co-produced hydrogen is used for chemical reactions, the ODC technique was reported in 2011 to be not economically viable [115, Jörissen et al. 2011].

The future economic assessment depends on the evolution of electricity prices, which in turn depend on the world energy markets, which could also be affected by carbon dioxide trading and taxes. In addition, the evolution of the 'hydrogen economy' could transform hydrogen from a co-product to a premium fuel, easily saleable on the hydrogen market [52, Moussallem et al. 2008].

Driving force for implementation

The driving force for implementation is a reduction of costs related to energy consumption.

Example plants

- Bayer/Uhde in Leverkusen (Germany), chlorine capacity 20 kt/yr, put into operation in summer 2011;
- Befar in Binzhou, Shandong (China), caustic soda capacity 80 kt/yr, of which the first 40 kt/yr were expected to be put into operation during the second semester of 2015.
- Two pilot units in testing in Japan.

Reference literature

[3, Euro Chlor 2011], [49, Euro Chlor 2010], [51, Bulan 2007], [52, Moussallem et al. 2008], [53, Bulan et al. 2009], [113, Moussallem et al. 2009], [115, Jörissen et al. 2011], [122, Bayer 2012], [333, Euro Chlor 2012], [344, Uhdenora 2014]

6.3 Four-stage caustic evaporator in membrane cell plants

Description

This technique consists in using a caustic evaporator with four stages in membrane cell plants.

Technical description

The caustic solution leaving the membrane cells (~ 32 wt-%) needs to be concentrated in many cases to 50 wt-% in order to be traded as a commodity. This is commonly achieved in two or three stages, using either plate or shell-and-tube evaporators [46, Ullmann's 2006].

In 2012, it was announced that the world's first caustic evaporator with four stages at a membrane cell plant would be installed at the AkzoNobel plant in Frankfurt (Germany). The evaporator consists of a one-stage shell-and-tube evaporator combined with a three-stage plate evaporator [233, AkzoNobel 2012]. The membrane cell plant was inaugurated in May 2014 [347, AkzoNobel 2014].

Achieved environmental benefits

The achieved environmental benefit of this technique is a reduction of energy consumption.

Environmental performance and operational data

At the AkzoNobel plant in Frankfurt (Germany), it was estimated that the steam consumption would be approximately 0.4 tonnes of medium-pressure steam per tonne of NaOH (100 %), and therefore approximately 20 % lower than that of the best three-stage evaporators commercially available at that time [144, Alfa Laval 2011], [233, AkzoNobel 2012].

Cross-media effects

Some raw materials and energy are consumed for the manufacture of the evaporator.

Technical considerations relevant to applicability

Generally, there are no technical restrictions to the application of this technique in membrane cell plants.

Plate evaporators require more maintenance due to more frequent changes of gaskets [316, Euro Chlor 2012]. They have, however, a more compact design than shell-and-tube evaporators [144, Alfa Laval 2011].

Economics

In general, the number of stages installed for caustic concentration depends on the available steam pressure, the temperature of the cooling water, and the costs of steam and cooling water. Increasing the number of stages reduces energy and cooling water consumption but increases investments costs. Relative investment costs for one-, two- and three-stage evaporators amount to 100 %, 160 % and 230 %, respectively [63, Euro Chlor 2011].

The advantage of one- and two-stage evaporation units is that low-pressure steam at approximately 3 bar can be used while three- and four-stage evaporators require the use of medium-pressure steam at approximately 10 bar. The use of low-pressure steam is favourable when a heat and power cogeneration unit is present on the site. Cogenerated steam is normally less expensive than the middle pressure steam required for a three- or four-stage caustic evaporation because it allows for more electricity production. Expanding one tonne of steam from 10 bar to 3 bar can produce approximately 20 kWh of electricity [63, Euro Chlor 2011].

Driving force for implementation

The driving forces for implementation of this technique include:

- installation of a new membrane cell unit or capacity increase of an existing unit;
- reduction of costs related to energy consumption.

Example plants

- AkzoNobel in Frankfurt (Germany), chlorine capacity of new membrane cell plant 250 kt/yr, inaugurated in 2014.

Reference literature

[46, Ullmann's 2006], [63, Euro Chlor 2011], [144, Alfa Laval 2011],
[233, AkzoNobel 2012], [316, Euro Chlor 2012], [347, AkzoNobel 2014]

7 CONCLUDING REMARKS AND RECOMMENDATIONS FOR FUTURE WORK

Timing of the review process

The key milestones of the review process are summarised in Table 7.1.

Table 7.1: Key milestones of the review process of the BREF for the Production of Chlor-Alkali

Key milestone	Date
Reactivation of the TWG	16 December 2008
Call for wishes	9 March 2009
Kick-off meeting	30 September to 2 October 2009
Collection of information, including first survey	October 2009 to April 2010
First draft of revised CAK BREF	21 December 2011
End of commenting period on first draft (429 comments received)	9 March 2012
Additional data collection (second survey)	May 2012
Final TWG meeting	11 to 14 December 2012

During the review process, a total of nine site visits in five EU Member States were carried out, comprising four mercury, four diaphragm and eight membrane cell plants.

Sources of information and information gaps

For the revised BREF for the Production of Chlor-Alkali (CAK BREF), more than 500 documents, including questionnaires, were shared by the TWG via the Commission's BAT Information System (BATIS), thereby ensuring a high level of transparency. Major contributors of information were the European IPPC Bureau (EIPPCB) and Euro Chlor, the European association of chlorine producers. Further information was provided by the European Environmental Bureau (EEB, a non-governmental organisation promoting environmental protection), and some EU Member States, mostly by Austria, France, the Netherlands, Spain, and the United Kingdom, but also by Belgium, the Czech Republic, Germany, Ireland, Italy, Portugal, Romania, Slovakia, and Slovenia. All these documents were assessed by the EIPPCB, together with more than 500 additional documents that were not shared via BATIS due to various reasons (e.g. confidentiality, copyright restrictions, relevance for the review). As a result, more than 300 documents are referenced in the revised CAK BREF (REFERENCES).

Degree of consensus reached during the information exchange

At the final TWG meeting in December 2012, a very high degree of consensus was reached on the BAT conclusions. However, one dissenting view was expressed by Austria and the European Environmental Bureau. These two TWG members considered that a BAT-associated emission level for emissions of chlorate to water should be added to the BAT conclusions considering 1) the chronic toxicity of chlorate to aquatic life, 2) the typically high emission loads from chlor-alkali plants, 3) the availability of data, 4) that chlorate is a pollutant specific to the chlor-alkali industry that will not be covered by the CWW BREF, and 5) that a performance level for chlorate concentrations in the brine was given in the original CAK BREF from 2001.

Consultation of the Forum and subsequent formal adoption procedure of the BAT Conclusions

The forum for the exchange of information pursuant to Article 13 of the Directive 2010/75/EU on industrial emissions (IED) (generally referred to as the IED Article 13 Forum) was consulted

on the proposed content of this BAT reference document on 8 April 2013 and provided its opinion during its meeting on 6 June 2013. The opinion of the IED Article 13 Forum distinguishes between two different sets of comments. Firstly, the opinion lists those comments on which the forum gave its consensus to include them in the final BAT reference document. Secondly, the opinion lists those comments representing the views of certain Forum members but on which there was no consensus to include them in the final BAT reference document. The full opinion of the Forum is available here:

<https://circabc.europa.eu> (Browse categories → European Commission / Environment → IED → Library → IED Art 13 Forum → Opinions of the IED Article 13 Forum)

Subsequently, the Commission took the opinion of the IED Article 13 Forum into account when preparing the draft Commission Implementing Decision establishing the BAT conclusions for the production of chlor-alkali. The Industrial Emissions Directive (IED) Article 75 Committee gave a positive opinion on the draft Implementing Decision in a written procedure from 9 August to 11 September 2013. The voting result on the formal opinion of the Committee is available here:

<http://ec.europa.eu/transparency/regcomitology/index.cfm?do=search.documentdetail&4g+PobGaYfqo/AGfesL69QtEDJcF1W+5HxEoEV+6uRkDftvKFOKx2dvStAkgOQoq>

No substantive modifications were made to the document between the opinion of the IED Article 13 Forum and the IED Article 75 Committee.

Subsequently, the Commission Implementing Decision 2013/75/EU establishing the best available techniques (BAT) conclusions for the production of chlor-alkali was adopted on 9 December 2013 and published in the Official Journal of the European Union (OJ L 332, 11.12.2013, p.34):

<http://eur-lex.europa.eu/LexUriServ/LexUriServ.do?uri=OJ:L:2013:332:0034:0048:EN:PDF>

Recommendations for future work

The information exchange revealed a number of issues where further information should be collected during the next review of the CAK BREF. These issues include:

- techniques to reduce the generation of waste water;
- electricity consumption of existing plants and techniques to increase their energy efficiency;
- use of iron(III) *meso*-tartrate as an anticaking agent and its potential to increase energy efficiency;
- emissions of chloride, chlorate, halogenated organic compounds and heavy metals to water, as well as techniques to reduce them;
- impact of chlorate emissions on the aqueous environment.

Some TWG members recommend working on the harmonisation of monitoring methods for pollutants for which no EN standards are currently available. This concerns in particular the monitoring of chlorine and chlorine dioxide.

Suggested topics for future R&D work

The Commission is launching and supporting, through its Research and Technological Development programmes, a series of projects dealing with clean technologies, emerging effluent treatment and recycling technologies and management strategies. Potentially, these projects could provide a useful contribution to future BREF reviews. Readers are therefore invited to inform the European IPPC Bureau of any research results which are relevant to the scope of this document (see also the fifth section of the Preface of this document).

8 ANNEXES

8.1 Installed chlorine production capacities

Table 8.1: Installed chlorine production capacities in the EU-27 and EFTA countries as of 1 January 2013

Euro Chlor No.	Country code	Company	Site	Caustic produced	Installed chlorine production capacity in kt/yr				
					Total	Mercury cell technique	Diaphragm cell technique	Membrane cell technique	Other techniques
1	AT	Donau Chemie	Brückl	NaOH	70	—	—	70	—
3	BE	Solvic	Antwerp-Lillo	NaOH	350	—	—	350	—
3	BE	Solvic	Antwerp-Zandvliet	NaOH	110	110	—	—	—
4	BE	Solvic	Jemeppe	NaOH	174	—	—	174	—
5	BE	INEOS ChlorVinyls	Tessengerlo	KOH	400 ⁽¹⁾	205	—	270	—
6	CZ	Spolana	Neratovice	NaOH	135	135	—	—	—
7	CZ	Spolchemie	Ústí nad Labem	NaOH, KOH	61	61	—	—	—
8	FI	AkzoNobel	Oulu	NaOH	40	40	—	—	—
9	FI	Kemira	Joutseno	NaOH	75	—	—	75	—
10	FR	PPChemicals	Thann	KOH	72	72	—	—	—
11	FR	Vencorex	Le Pont de Claix	NaOH	170	—	170	—	—
12	FR	Kem One	Fos-sur-Mer	NaOH	300	—	150	150	—
13	FR	Arkema	Jarrie	NaOH	73	73	—	—	—
14	FR	Kem One	Lavéra	NaOH	341	166	175	—	—
15	FR	Arkema	Saint Auban	NaOH	20	—	—	20	—
16	FR	Métaux Spéciaux SA (MSSA)	La Pomblière	NA	42	—	—	—	42 ⁽²⁾
17	FR	PC Harbonnières	Harbonnières	NaOH, KOH	23	23	—	—	—
18	FR	Solvay	Tavaux	NaOH	360	—	—	360	—
19	FR	PC Loos	Loos	KOH	18	18	—	—	—
20	DE	BASF	Ludwigshafen	NaOH, KOH	385	170 ⁽³⁾	—	215	—
21	DE	Bayer MaterialScience	Dormagen	NaOH	480	—	—	400	80 ⁽⁴⁾
22	DE	Bayer MaterialScience	Leverkusen	NaOH	330	—	—	330	—
23	DE	Bayer MaterialScience	Uerdingen	NaOH	250	—	—	250	—
24	DE	Bayer MaterialScience	Brunsbüttel	NA	210	—	—	—	210 ⁽⁴⁾
25	DE	Dow	Schkopau	NaOH	250	—	—	250	—
26	DE	Vinnolit	Knapsack	NaOH	250	—	—	250	—
27	DE	CABB	Gersthofen	NaOH	45	—	—	45	—

Euro Chlor No.	Country code	Company	Site	Caustic produced	Installed chlorine production capacity in kt/yr				
					Total	Mercury cell technique	Diaphragm cell technique	Membrane cell technique	Other techniques
28	DE	Dow	Stade	NaOH	1 585	—	1 030	555	—
29	DE	AkzoNobel	Ibbenbüren	NaOH	125	125	—	—	—
30	DE	AkzoNobel	Bitterfeld	NaOH	99	—	—	99	—
31	DE	Evonik Industries	Lülsdorf	NaOH, KOH	137	137 ⁽³⁾	—	—	—
32	DE	INEOS ChlorVinyls	Wilhelmshaven	NaOH	149 ⁽⁵⁾	149	—	—	—
33	DE	AkzoNobel	Frankfurt	NaOH	167 ⁽⁶⁾	167	—	—	—
34	DE	Solvay	Rheinberg	NaOH	220	—	110	110	—
35	DE	Vestolit	Marl	NaOH	260	—	—	260	—
36	DE	Vinnolit	Gendorf	NaOH	180	—	—	180	—
37	DE	Wacker Chemie	Burghausen	NaOH	50	—	—	50	—
38	EL	Hellenic Petroleum	Thessaloniki	NaOH	40	40	—	—	—
39	HU	Borsodchem	Kazincbarcika	NaOH	291	131	—	160	—
40	IE	MicroBio	Fermoy	NaOH	9	—	—	9	—
41	IT	Altair Chimica	Volterra	KOH	39	—	—	39	—
42	IT	Solvay	Bussi	NaOH	25	—	—	25	—
44	IT	Syndial	Assemini	NaOH	150	—	—	150	—
49	IT	Solvay	Rosignano	NaOH	150	—	—	150	—
50	IT	Tessenderlo Chemie	Pieve Vergonte	NaOH	42	42	—	—	—
51	NL	AkzoNobel	Rotterdam-Botlek	NaOH	637	—	—	637	—
52	NL	AkzoNobel	Delfzijl	NaOH	121	—	—	121	—
54	NL	SABIC	Bergen op Zoom	NaOH	89	—	—	89	—
55	NO	Borregaard	Sarpsborg	NaOH	45	—	—	45	—
56	NO	Elkem	Bremanger	NaOH	10	—	—	10	—
57	NO	INEOS ChlorVinyls	Rafnes	NaOH	260	—	—	260	—
58	PL	PCC Rokita	Brzeg Dolny	NaOH	125	77	—	48	—
60	PL	Anwil	Włocławek	NaOH	214	—	—	214	—
61	PT	Solvay	Póvoa de Santa Iria	NaOH	26 ⁽⁷⁾	—	—	26	—
62	PT	CUF	Estarreja	NaOH	116	—	—	72	44 ⁽⁴⁾
63	SK	Fortischem	Nováky	NaOH	76	76	—	—	—
64	ES	Ercros	Palos de la Frontera	NaOH	48	48	—	—	—
65	ES	Ercros	Sabiñánigo	KOH	30	—	—	30	—
66	ES	Ercros	Vilaseca	NaOH	190	135	—	55	—

Euro Chlor No.	Country code	Company	Site	Caustic produced	Installed chlorine production capacity in kt/yr				
					Total	Mercury cell technique	Diaphragm cell technique	Membrane cell technique	Other techniques
67	ES	Electroquímica de Hernani	Hernani	NaOH	15	—	—	15	—
68	ES	Elnosa	Lourizán	NaOH	34	34	—	—	—
69	ES	Ercros	Flix	NaOH	115	115	—	—	—
70	ES	Química del Cinca	Monzón	NaOH	31	31	—	—	—
71	ES	Hispavic	Martorell	NaOH	218	218	—	—	—
72	ES	Solvay	Torrelavega	NaOH	63 ⁽⁷⁾	63	—	—	—
75	SE	INEOS ChlorVinyls	Stenungsund	NaOH	120	120	—	—	—
77	CH	CABB	Pratteln	NaOH	27	27	—	—	—
82	UK	INEOS ChlorVinyls	Runcorn	NaOH	707 ⁽⁷⁾	277	—	430	—
85	UK	Brenntag	Theftord	NaOH	7	—	—	7	—
88	SI	TKI Hrastnik	Hrastnik	NaOH	16	—	—	16	—
91	RO	Oltchim	Râmnicu Vâlcea	NaOH	291	186	—	105	—
92	RO	Chimcomplex	Borzești	NaOH	93	—	—	93	—
93	IT	Procter and Gamble	Campocharo	NaOH	20	—	—	20	—
94	EL	Kapachim	Inofita Viotias	NaOH	4	—	—	4	—
95	EL	Unilever Knorr	Marousi	NaOH	20	—	—	20	—
96	DE	Leuna-Tenside	Leuna	NaOH	15	—	—	15	—
97	UK	Industrial Chemicals	West Thurrock	NaOH	15	—	—	15	—
Total					12 550	3 271	1 635	7 343	376
Total chlor-alkali					NA	12 174			NA
Percentage of total					100 %	26.1 %	13.0 %	58.5 %	3.0 %
⁽¹⁾ Permitted production capacity. ⁽²⁾ Electrolysis of molten sodium chloride. ⁽³⁾ A part of the capacity is dedicated to the production of specialities such as alcoholates and thiosulphates instead of caustic. ⁽⁴⁾ Electrolysis of hydrochloric acid. ⁽⁵⁾ Plant was shut down in the course of the year 2013. ⁽⁶⁾ Plant was converted into a membrane cell plant in 2014, with a chlorine production capacity of 250 kt/yr. ⁽⁷⁾ Plant uses a once-through brine system. NB: NA = not applicable. Source: [9, Euro Chlor 2013], [57, CAK TWG 2012], [347, AkzoNobel 2014], [348, INEOS ChlorVinyls 2013]									

8.2 Techniques to reduce mercury emissions and to reduce the generation of waste contaminated with mercury

8.2.1 Overview

Section 8.2.2 presents a summary of techniques to reduce mercury emissions and to reduce the generation of wastes contaminated with mercury **during normal plant operation**. Sections 8.2.3 and 8.2.4, respectively, address in more detail end-of-pipe techniques to reduce mercury emissions to air and water, Section 8.2.5 the removal of mercury from caustic soda and Section 8.2.6 the treatment of wastes contaminated with mercury. Techniques to reduce mercury emissions and to reduce the generation of wastes contaminated with mercury **during decommissioning** are described in Section 4.1.3.1. Many of the techniques used during decommissioning are also used during normal plant operation.

8.2.2 Summary of techniques to reduce mercury emissions and to reduce the generation of wastes contaminated with mercury

Description

A wide variety of techniques are used to reduce emissions of mercury to air and water, to reduce the mercury content of products and to reduce the generation of wastes contaminated with mercury.

Technical description

During the operation of mercury cell plants, mercury emissions occur to air and water and mercury also leaves the plant via products and wastes. Although emissions have been greatly reduced (Figure 3.4 and Figure 3.5), further improvements are still possible in several plants by using a variety of techniques, many of which are part of what is called 'good housekeeping'. Guiding principles for good housekeeping are that no visible mercury is to be tolerated anywhere in the workplace and that mercury covered with water is to be tolerated only when completely unavoidable and for extremely short periods [89, Euro Chlor 2004].

Techniques to reduce mercury emissions include:

1. Management system, including [89, Euro Chlor 2004]:
 - a. detailed service routines;
 - b. training and motivation of personnel;
 - c. mercury balance to better understand mercury consumption and emission levels, including [86, Euro Chlor 2010]:
 - i. use of a recognised standard methodology;
 - ii. purging of all equipment where mercury may accumulate before making the balance, if possible;
 - iii. accurate inventory of mercury in cells and in store;
 - iv. use of high-performance monitoring systems.
2. Suitable cell room that is [89, Euro Chlor 2004]:
 - a. equipped with a smooth, crack-free, light-coloured, and impervious floor that is sloped towards open floor gutters;
 - b. well-lit to enable easy identification and clean-up of spills;
 - c. free of obstructions and debris that may absorb mercury and/or hinder the clean-up of spills;
 - d. avoiding equipment where mercury may accumulate (e.g. hang cable trays vertically);
 - e. connected to a waste water treatment system.
3. Monitoring and leak detection/repair, including [89, Euro Chlor 2004]:
 - a. continuous mercury monitoring in the cell room;

- b. leak detection using equipment sensitive to hydrogen;
 - c. scheduled programme of preventative maintenance for seals and valves;
 - d. immediate repair of identified leaks, if possible.
4. Cleaning and recovery of mercury, including [89, Euro Chlor 2004]:
 - a. immediate isolation of recovered mercury in closed vessels;
 - b. immediate removal of mercury spillages by using vacuum cleaners equipped with activated carbon filters;
 - c. daily cleaning of the floor by gentle flushing with water; avoidance of high-pressure washing due to the potential formation of micro droplets of mercury.
 5. Storage of mercury and of waste contaminated with mercury in suitable areas (see description of cell room above) [89, Euro Chlor 2004];
 6. Process-integrated techniques during normal operation to stabilise operating conditions and to reduce the frequency of cell opening, including [116, Euro Chlor 2013]:
 - a. use of high-purity salt;
 - b. verification and cleaning of inter-cell buses for good current distribution;
 - c. monitoring of mercury pressure and flow;
 - d. optimisation of mercury quantity in cells;
 - e. adjustment of anodes over different cell segments;
 - f. computerised control of electrode gap, current and voltage;
 - g. computerised system for tracking the life of cell components;
 - h. graphite reactivation without opening the decomposer, if possible, for example by treatment with sodium molybdate, ferric sulphate or cobalt.
 7. Process-integrated techniques during maintenance and repair operations to reduce mercury evaporation, including [89, Euro Chlor 2004]:
 - a. scheduled programme of preventative maintenance;
 - b. detailed service routines for cell dismantling;
 - c. reduction of duration of cell opening by ensuring the availability of personnel and spare parts, including a spare decomposer completely assembled with carbon, if possible;
 - d. suitable working areas (see description of cell room above);
 - e. cell cooling during maintenance;
 - f. avoidance of use of rubber hoses for mercury transfer, as they are difficult to decontaminate;
 - g. removal of all residual visible mercury by using vacuum cleaners equipped with activated carbon filters;
 - h. cleaning of the cell bottom with an alkaline sodium peroxide solution and water; check cleaning operation with portable mercury analysers;
 - i. avoidance of stepping into the cell bottom, as shoes are difficult to decontaminate;
 - j. covering of all equipment from which mercury may evaporate, in case of interruption of operation.
 8. End-of-pipe techniques, including [87, Euro Chlor 2006]:
 - a. mercury removal from process exhaust originating from (Section 8.2.3.1)
 - i. closed end-boxes and separate end-box ventilation;
 - ii. vacuum cleaners;
 - iii. mercury pump seals;
 - iv. brine circuit and salt dissolver;
 - v. mercury distillation/retorting;
 - b. mercury removal from hydrogen (Section 8.2.3.2);
 - c. mercury removal from waste water (Section 8.2.4);
 - d. mercury removal from caustic soda (Section 8.2.5).

Achieved environmental benefits

The achieved environmental benefits of these techniques include:

- reduction of mercury emissions to air and water;
- reduction of mercury content of products;
- reduction of the generation of waste contaminated with mercury.

Environmental performance and operational data

The overall emissions of mercury from a plant depend on the combined effect of all techniques used. Other factors that influence mercury emissions are described in Section 3.5.6.2.2.

An overview of techniques applied by two plants that achieved very low mercury emission levels from 2005 to 2011 is given in Table 8.2 and Table 8.3. These two plants were put into operation around 1970. From the beginning, the operators took the abatement of mercury emissions into consideration. The low emission levels were achieved by implementing a large number of techniques and continuous improvements.

Table 8.2: Overview of applied techniques and mercury emission levels at the INEOS ChlorVinyls plant in Stenungsund (Sweden) from 2005 to 2011

Mercury source	Applied techniques	Residual mercury concentration (annual average)	Flow	Hg emission/loss in g/t annual chlorine capacity (annual average)	Recipient medium
All sources	<ul style="list-style-type: none"> Detailed service routines Training and motivation of personnel Continuous mercury monitoring Computerised control of current and voltage Vacuum salt 	NA	NA	NA	All
Cell room	<ul style="list-style-type: none"> Improved sealing of equipment Closing and suction of outlet end-boxes Ground floor coated with polyurethane Electrolysers situated on first floor Immediate removal of spillage Cell cooling during maintenance 	2–8 µg/m ³ (in cell room)	300 000–600 000 m ³ /h or 22 500–45 000 m ³ /t chlorine produced	0.12–0.17	Air
Process waste gas (including vacuum cleaner and depleted pre-coat drying)	<ul style="list-style-type: none"> Anolyte scrubbing of vents from mercury pumps' gland seals Inlet end-boxes are connected to hydrogen treatment Activated carbon filtration on cleaners' discharge 	< 1 µg/m ³ (in waste gas)	20 m ³ /min when using the vacuum cleaner	< 0.000 5	Air
Hydrogen	Activated carbon filtration	< 10 µg/m ³ (in H ₂)	311 m ³ H ₂ /t chlorine produced	0.002	Air or product
Waste water	Treatment with hydrazine, followed by sedimentation, sand filtration and activated carbon filtration	< 20 µg/l (in waste water)	<37 000 m ³ /yr	0.00–0.01	Water
Caustic soda	Activated carbon filtration	5–10 µg/l (in 50 wt-% NaOH)	1.128 t of 100% NaOH/t chlorine produced	~ 0.01	Product
Total				0.13–0.18	Air, products and water
Waste	No treatment on site. The caustic filter residue and the waste water sludge are stored for treatment in a distillation unit off site. The amount of recovered mercury is unknown. Brine filtration sludge is landfilled.	NI	NI	0.0–39	Waste
NB: NA = not applicable; NI = no information provided.					
Source: [55, Euro Chlor 2014], [116, Euro Chlor 2013]					

Table 8.3: Overview of applied techniques and mercury emission levels at the Solvin plant in Antwerp-Lillo (Belgium) from 2005 to 2011

Mercury source	Applied techniques	Residual mercury concentration (annual average)	Flow	Hg emission/loss in g/t annual chlorine capacity (annual average)	Recipient medium
All sources	<ul style="list-style-type: none"> Detailed service routines Training and motivation of personnel Continuous mercury monitoring Computerised control of current and voltage Adjustment of anodes over different cell segments Monitoring of mercury flow 	NA	NA	NA	All
Cell room	<ul style="list-style-type: none"> Improved sealing of equipment Closing and suction of end-boxes Ground floor coated with acrylate resin Electrolysers situated on first floor Immediate removal of spillage Cell cooling during maintenance 	2–8 µg/m ³ (in cell room)	1 500 000 m ³ /h or 70 000 m ³ /t chlorine produced	0.17–0.25	Air
Process waste gas (including vacuum cleaner and depleted pre-coat drying)	<ul style="list-style-type: none"> Activated carbon filtration (end-boxes are connected to chlorine and hydrogen treatment) 	< 1 µg/m ³ (in waste gas)	20 m ³ /min when using the vacuum cleaner	0.01–0.13	Air
Hydrogen	Activated carbon filtration	< 10 µg/m ³ (in H ₂)	311 m ³ H ₂ /t chlorine produced; maximum flow 8 000 m ³ /h	0.002	Air or product
Waste water	Treatment with sulphide, followed by sedimentation and sand filtration	< 20 µg/l (in waste water)	< 1 000 000 m ³ /yr	0.01–0.04	Water
Caustic soda	Activated carbon filtration	5–15 µg/l (in 50 wt-% NaOH)	1.128 t of 100% NaOH/t chlorine produced	0.02–0.09	Product
Total				0.26–0.45	Air, products and water
Waste	No treatment on site. Wastes are treated off site and landfilled	NI	NI	0.0–25	Waste

NB: NA = not applicable; NI = no information provided.
Source: [55, Euro Chlor 2014], [116, Euro Chlor 2013]

Old cell-room buildings are sometimes contaminated with mercury and the effects of techniques to reduce mercury emissions from the cell room might only be noticeable after several years, when a new equilibrium is reached.

Table 8.4 shows mercury emission levels to air and water and mercury losses with products that can be achieved at best by applying the aforementioned techniques.

Table 8.4: Mercury emission levels to air and water and mercury losses with products that can be achieved at best

Recipient medium	Mercury source	Mercury emission/loss in g/t annual chlorine capacity (annual average)
Air	Cell room	0.2–0.3
	Process exhaust, including mercury distillation unit	0.0003–0.01
	Untreated cooling air from mercury distillation unit	0.006–0.1
Air/Product	Hydrogen	< 0.003
Water	Waste water	0.004–0.055
Product	Caustic soda	0.01–0.05
Total		0.2–0.5
<i>Source: [116, Euro Chlor 2013]</i>		

Cross-media effects

Some raw materials and energy are consumed when techniques are applied to remove mercury from waste gas, waste water, and products. The resulting wastes require further treatment and/or disposal (Section 8.2.6).

Some techniques to treat process waste gases, waste water and wastes generate less waste or waste that can be directly recycled into the process, but they show poorer performance in terms of mercury abatement than other techniques (e.g. mercury removal from waste gases with chlorine-containing brine or with the calomel reaction; see Section 8.2.3).

Some of the substances used to remove mercury from waste water are toxic (e.g. hydrazine) or can lead to the formation of toxic substances (e.g. the formation of hydrogen sulphide from sulphide upon pH decrease).

Technical considerations relevant to applicability

Generally, there are no technical restrictions to the applicability of these techniques.

Economics

Table 4.7 includes some figures for estimated costs related to the removal of mercury from waste gas, waste water, products and waste, as well as related to monitoring and labour.

Driving force for implementation

The driving forces for implementation of these techniques include:

- environmental legislation;
- occupational health and safety legislation;
- improvement of product quality;
- reduction of costs related to the disposal of waste contaminated with mercury.

Example plants

- INEOS ChlorVinyls in Stenungsund (Sweden), chlorine capacity 120 kt/yr, 64 electrolyzers of Uhde design (cathode area 15 m²); put into operation in 1969;
- Solvin in Antwerp-Lillo (Belgium), chlorine capacity of mercury cell unit 180 kt/yr, 108 electrolyzers of Solvay design (cathode area 17 m²), put into operation in 1970. The plant was converted to the membrane cell technique in 2012.

Reference literature

[55, Euro Chlor 2014], [86, Euro Chlor 2010], [87, Euro Chlor 2006], [89, Euro Chlor 2004], [116, Euro Chlor 2013]

8.2.3 Reduction of mercury emissions to air, including hydrogen

8.2.3.1 Removal of mercury from process exhausts

Overview

Process exhausts refer to all gaseous streams by which mercury can be emitted to air, apart from cell room ventilation air and hydrogen as product. The sources of process exhaust are described in Section 3.5.6.3.1. Some streams may be combined prior to treatment, while others require separate treatment units. For example, hydrogen streams are usually not mixed with streams containing significant amounts of air, in order to prevent the formation of explosive mixtures [87, Euro Chlor 2006].

Mercury is mainly removed by [1, Ullmann's 2006], [87, Euro Chlor 2006]:

- adsorption on iodised or sulphurised activated carbon;
- scrubbing with hypochlorite or chlorinated brine to form mercury(II) chloride;
- adding chlorine to form dimercury dichloride (calomel), which is collected on a solid substrate, such as rock salt in a packed column.

Mercury concentrations in treated process exhaust are typically $\leq 30 \mu\text{g}/\text{m}^3$ [87, Euro Chlor 2006].

Adsorption on iodised or sulphurised activated carbon

Many plants use adsorption on iodised or sulphurised activated carbon.

Activated carbon filtration generates a waste contaminated with mercury that requires further treatment and/or disposal. Metallic mercury can be recovered from this waste by distillation (Section 8.2.6).

Scrubbing with hypochlorite or chlorinated brine

Scrubbing is generally carried out in packed columns with a countercurrent flow of hypochlorite or chlorinated brine. Elemental mercury is oxidised and the resulting liquid can be recycled to the brine system. In the case of using chlorinated brine as scrubbing liquid, the waste gas requires further treatment in the chlorine absorption unit to remove chlorine, while in the case of using alkaline hypochlorite solution, the waste gas only needs to pass through a separator to remove entrained liquid droplets [343, UBA DE 1997].

Residual mercury concentrations after treatment were reported to be 50–100 $\mu\text{g}/\text{m}^3$, corresponding to 0.006–0.01 g/t annual chlorine capacity [343, UBA DE 1997].

For a plant with a chlorine capacity of 100 kt/yr and a waste gas flow of 2000 m³/h, the costs for a scrubbing system in 1997 (either using hypochlorite or chlorine-containing brine) were reported to be DEM 1.8/t chlorine produced (equivalent to EUR 0.9/t chlorine produced, EUR/DEM = 1.97, currency conversion date November 1997) [343, UBA DE 1997].

Calomel reaction

By adding chlorine, elemental mercury is converted to dimercury dichloride (calomel, Hg_2Cl_2), which is collected on a solid substrate, such as rock salt in a packed column. The solid can be regenerated using chlorine-containing brine, which is then recycled to the brine system [343, UBA DE 1997].

Residual mercury concentrations after treatment were reported to be 50–100 $\mu\text{g}/\text{m}^3$, corresponding to 0.006–0.01 g/t annual chlorine capacity [343, UBA DE 1997]. However, ICI reported that a simple fluidised scrubber system could lead to increased mercury emissions. Improved performance could be achieved by using 'spinning mop' scrubbers [116, Euro Chlor 2013].

For a plant with a chlorine capacity of 100 kt/yr and a waste gas flow of 2000 m^3/h , the costs for a calomel system in 1997 were reported to be DEM 2.6/t chlorine produced (equivalent to EUR 1.3/t chlorine produced, EUR/DEM = 1.97, currency conversion date November 1997) [343, UBA DE 1997].

8.2.3.2 Removal of mercury from hydrogen

Overview

The hydrogen gas stream is nearly saturated with mercury when it leaves the decomposer at a temperature of 90–130 °C. The saturation concentration of mercury in the gas phase is 0.836 g/m^3 at 80 °C, and 2.40 g/m^3 at 100 °C [1, Ullmann's 2006]. This mercury is generally removed in a multi-stage process [87, Euro Chlor 2006].

In the first step, the hydrogen is cooled by a heat exchanger mounted immediately above the cell or a cooler within the decomposer. The condensed mercury is recycled with water and sent directly to the decomposer [87, Euro Chlor 2006].

The second stage may involve [87, Euro Chlor 2006]:

- chilling or washing with chilled water;
- compression and cooling;
- scrubbing with hypochlorite;
- use of a calomel reaction.

With the first two options, mercury is recovered as metallic mercury; with the last two options, the resulting liquid can be recirculated to the brine (Section 8.2.3.1). Various techniques are available for the third stage.

Adsorption of mercury on iodised or sulphurised activated carbon

Most commonly, mercury is removed by adsorption on iodised or sulphurised activated carbon, after sufficient increase of the hydrogen temperature (10–20 °C) to prevent water condensation in the carbon bed [87, Euro Chlor 2006]. Residual mercury concentrations were reported to be typically in the range of 2–30 $\mu\text{g}/\text{m}^3$ [1, Ullmann's 2006] or below 30 $\mu\text{g}/\text{m}^3$, corresponding to approximately 0.01 g/t annual chlorine capacity [87, Euro Chlor 2006]. If the hydrogen is compressed before treatment, lower mercury concentrations of approximately 10 $\mu\text{g}/\text{m}^3$ can be achieved, corresponding to approximately 0.003 g/t annual chlorine capacity [87, Euro Chlor 2006].

At the INEOS ChlorVinyls plant in Stenungsund (Sweden), residual mercury concentrations in hydrogen amounted to less than 10 $\mu\text{g}/\text{m}^3$ in 2005 to 2011, corresponding to 0.002 g/t annual chlorine capacity (Table 8.2). At the Solvin plant in Antwerp-Lillo (Belgium), residual mercury concentrations in hydrogen amounted to less than 10 $\mu\text{g}/\text{m}^3$ in 2005 to 2011, corresponding to 0.002 g/t annual chlorine capacity (Table 8.3).

Activated carbon filtration generates a waste contaminated with mercury that requires further treatment and/or disposal. Metallic mercury can be recovered from this waste by distillation (Section 8.2.6).

At the Kem One (formerly Arkema) plant in Lavéra (France), the investment costs for a sulphurised activated carbon filtration system in 1997 amounted to EUR 0.45–0.5 million, including the heat exchanger necessary to increase the temperature after the cooling step to 20–25 °C, the equipped tower and the necessary filters. The sulphurised activated carbon needs to be changed every two to three years. Its lifetime can be longer, depending on the efficiency of the cooling step [116, Euro Chlor 2013].

Mercury removal using cupric oxide

Alternatively, mercury may be removed in the third stage by using copper(II) oxide. At the Solvin plant in Antwerp-Lillo (Belgium), the average mercury concentration in hydrogen achieved with this technique is 10 µg/m³, corresponding to 0.003 g/t annual chlorine capacity [116, Euro Chlor 2013].

Adsorption of mercury on copper/aluminium oxide or on silver/zinc oxide

Mercury concentrations of less than 1 µg/m³ can be achieved when adsorption on copper on an aluminium oxide carrier or on silver on a zinc oxide carrier is used as the third stage, at temperatures of 2–20 °C [1, Ullmann's 2006], [87, Euro Chlor 2006].

8.2.4 Reduction of mercury emissions to water

The sources of waste water contaminated with mercury are described in Section 3.5.7.1. Most of these streams can be recycled into the process, thereby achieving waste water volumes of 0.3–1.0 m³/tonne of chlorine produced [1, Ullmann's 2006].

Various techniques exist to reduce the mercury levels in the residual waste water prior to its discharge. These techniques together with their performance levels are described in Section 4.1.3.1 and Table 4.10.

8.2.5 Removal of mercury from caustic soda

The 50 wt-% caustic soda leaving the mercury cells usually contains metallic mercury in the range of 2.5–25 mg/l, depending on the type of denuder and temperature. For some applications very pure sodium or potassium hydroxide are needed.

The predominant technique to reduce mercury levels in caustic soda is activated carbon filtration in pre-coated candle or plate filters. The mercury is absorbed on a special carbon pre-coat and removed from the filter as a dry cake. This technique guarantees a maximum mercury content of 50 µg/l in 50 wt-% caustic, if the mercury content before filtration is in the range of 5–20 mg/l [116, Euro Chlor 2013]. The caustic filtration unit is sensitive to flowrate changes and low mercury levels are only achieved during undisturbed operation [17, Dutch Ministry 1998].

At the INEOS ChlorVinyls plant in Stenungsund (Sweden), filter areas amount to 80 m². Residual mercury concentrations in 50 wt-% caustic soda amounted to 5–10 µg/l in 2005 to 2011, corresponding to approximately 0.01 g/t annual chlorine capacity (Table 8.2). At the Solvin plant in Antwerp-Lillo (Belgium), residual mercury concentrations in 50 wt-% caustic soda amounted to 5–15 µg/l in 2005 to 2011, corresponding to 0.02–0.09 g/t annual chlorine capacity (Table 8.3).

Activated carbon filtration generates a waste contaminated with mercury that requires further treatment and/or disposal. Metallic mercury can be recovered from this waste by distillation (Section 8.2.6).

In 1998, the price of one filter with an area of 15 m² was approximately BEF 5 million (equivalent to approximately EUR 0.12 million, EUR/BEF = 40.59, currency conversion date August 1998), while the costs for its installation including all operating instruments amounted to approximately BEF 10 million (equivalent to approximately EUR 0.25 million) [342, Solvay 1998].

8.2.6 Treatment of wastes contaminated with mercury

Most of the mercury leaving a mercury cell chlor-alkali plant is contained in the various wastes from the process including wastes from mercury emission abatement. Additionally, there are solid wastes from maintenance, construction and demolition that may be contaminated with mercury. Table 4.8 provides an overview of waste types and possible decontamination techniques. The table is related to the decommissioning phase of a mercury cell plant, but the same types of waste also arise during normal plant operation.

The choice of the appropriate decontamination technique depends on the location of the mercury, its concentration and its chemical state for each category of waste. It is therefore essential to characterise each waste prior to treatment, preferably by chemical analysis. However, representative sampling may be difficult, because solid wastes are often inhomogeneous. This may result in estimates having to be made.

A waste management plan is usually drawn up and shared with the permitting authorities. Such a plan generally aims at reducing the quantity of waste contaminated with mercury sent for disposal and at recycling mercury back to the process. Elements of such a plan include [116, Euro Chlor 2013]:

- detailed service routines;
- provisions for records to be kept;
- descriptions of the different types of wastes that are generated and techniques to reduce their generation;
- provisions for the quantification of the different types of waste;
- provisions for storage;
- provisions for waste treatment, including stabilisation and final disposal, both on site and off site;
- methods and frequencies for sampling and analysis before and after waste treatment.

Table 8.5 gives an overview of techniques for the treatment of wastes contaminated with mercury with typical performance levels. Further examples are given in Table 3.37 and Table 3.38.

Table 8.5: Overview of techniques for the treatment of wastes contaminated with mercury with typical performance levels

Waste type	Characteristics/ Typical amounts	Mercury content before treatment in g/kg	Treatment	Final mercury content in mg/kg
Brine sludge (Section 3.5.9.2)	Up to 20 kg/t Cl ₂ produced, depending on salt quality	< 0.15	Landfilled after stabilisation	NI
Graphite from decomposers (Section 3.5.9.6)	10–20 g/t Cl ₂ produced	10–100	<ul style="list-style-type: none"> • Distillation • Landfilled after stabilisation 	20–200
Activated carbon from treatment of process exhausts and hydrogen (Section 3.5.9.5)	10–20 g/t Cl ₂ produced	100–200	<ul style="list-style-type: none"> • Chemical treatment • Landfilled after stabilisation 	20–200
Activated carbon from waste water treatment (Section 3.5.9.4)	50–400 g/t Cl ₂ produced	10–50	<ul style="list-style-type: none"> • Distillation • Landfilled after stabilisation 	< 10
Activated carbon from caustic filtration (Section 3.5.9.3)	20–50 g/t Cl ₂ produced	150–500	<ul style="list-style-type: none"> • Distillation • Landfilled after stabilisation 	20–200
Sludges from storage tanks, sumps, etc.	Potentially considerable amounts	Often high mercury content	Distillation	NI
Rubber lining	Variable amounts	Variable	<ul style="list-style-type: none"> • Acid bath, cryogenic and/or washing • Incineration 	300
Coated metallic materials	Contamination of surface	Usually < 1	Thermal, cut and washed, or cryogenic	NI
Steel/iron construction parts	Variable amounts	Inhomogeneous, usually < 10	<ul style="list-style-type: none"> • Acid bath • Sold as scrap 	< 5–10
Concrete and other construction waste	Variable amounts	Inhomogeneous, usually < 1	Landfilled as hazardous waste or as other waste, depending on content	> 10 < 10
NB: NI = no information provided. <i>Source:</i> [243, Stenhammar 2000]				

Mechanical and physical treatment

Mechanical and physical treatment include washing with water (with or without pressure), ultrasonic vibration, and vacuum cleaners with appropriate adsorption or condensation systems. Mechanical and physical treatments are suitable if significant quantities of metallic mercury are present [87, Euro Chlor 2006], [94, Euro Chlor 2009]. Other techniques include cryogenic treatment with nitrogen for rubber-coated steel or coated metallic materials [45, Euro Chlor 1997] and warm sandblasting in a fluidised bed for coated metallic materials [116, Euro Chlor 2013]. The resulting liquid streams usually require further treatment. All treatment techniques may result in mercury emissions to air [87, Euro Chlor 2006], [94, Euro Chlor 2009].

Chemical treatment

Chemical treatment includes treatment with hypochlorite, chlorinated brine or hydrogen peroxide. The liquid streams may be recycled to the brine system or treated as waste water, with recovery and recycling of mercury (Section 4.1.3.1) [87, Euro Chlor 2006].

Distillation/retorting

Distillation/retorting is used by many mercury cell chlor-alkali plants. Some of these plants have their own retorting unit, while others use the services of an external retorting company [59, Euro Chlor 2010], [94, Euro Chlor 2009].

Distillation of mercury from solid waste can be carried out in special distillation units, if mercury is present in its elemental form. Some solid waste can therefore not be distilled (for example, when the mercury is present as a salt; see Table 4.8). The mercury is recovered as metallic mercury and can be used for future make-up to the cells [45, Euro Chlor 1997]. Distillation largely removes mercury from waste to residual levels of typically less than 50 mg/kg [17, Dutch Ministry 1998].

Process exhausts from the mercury distillation unit are usually further treated (Section 8.2.3.1). After treatment, the residue may be cooled by ventilation air. This ventilation air contains a small amount of mercury. At the Solvin plant in Antwerp-Lillo (Belgium), the residual mercury concentration in ventilation air is less than $10 \mu\text{g}/\text{m}^3$, corresponding to less than 0.005 g/t annual chlorine capacity [116, Euro Chlor 2013].

The solid residue from distillation is landfilled or stored underground.

Stabilisation and final disposal

In most cases, the solid residues contaminated with mercury that result from treatment require stabilisation before being disposed of. Stabilisation serves to transform mercury and its compounds into a less soluble form, to reduce the risk of leaching from the final disposal site. In many cases, mercury is treated with sulphur or sulphur compounds to transform it to mercury sulphide. This can also be combined with physical stabilisation, for example in cement-based materials. After stabilisation, the waste is landfilled or stored underground.

8.3 Techniques to reduce emissions of asbestos and to reduce the generation of asbestos-containing waste

Description

The techniques described in this section include the training of personnel, provision of suitable working areas, appropriate handling of asbestos, treatment of waste gases, prevention of diaphragm deterioration, and regular monitoring.

Technical description

Emissions of asbestos to air in a diaphragm cell plant most likely occur when the asbestos is dry, i.e. during the handling stages prior to preparing the asbestos suspension and during the handling of spent asbestos. Asbestos that is suspended in water does not directly have the potential to be emitted to the atmosphere. However, wet asbestos may dry out and then become airborne. When the diaphragms on the cathode have been dried, the fibres are embedded in the fluoropolymer matrix and hence are not likely to be emitted to the atmosphere, unless the diaphragm is damaged [17, Dutch Ministry 1998], [45, Euro Chlor 1997], [215, German Ministry 2011].

Emissions to air

Emissions of asbestos to air can be reduced by [17, Dutch Ministry 1998], [45, Euro Chlor 1997]:

1. provision of procedures and instructions, as well as a detailed training and supervision programme for personnel involved in asbestos handling;
2. providing working areas for handling dry asbestos that are:
 - (a) enclosed and isolated with lock chamber access;
 - (b) equipped with smooth and sealed floors and walls;
 - (c) access-restricted;
 - (d) operated with negative pressure;
 - (e) equipped with absolute filters to treat ventilation air (absolute filters are described in the CWW BREF [124, EC 2003]);
 - (f) free of obstructions and debris that may adsorb asbestos and/or hinder cleaning (e.g. wooden pallets);
 - (g) equipped with automated systems so that no or only minimum handling of dry asbestos by personnel is necessary;
3. appropriate handling of asbestos by:
 - (a) using shrink-wrapped, sheet-wrapped or other non-porous packaging material for palletising and covering the bags during transport;
 - (b) fully cutting the bags and carefully emptying them with minimal disturbance (no shaking);
 - (c) folding of empty bags over the cut and depositing them in a closed and labelled container;
 - (d) rapidly cleaning up any visible dry asbestos on the floor or on equipment, by wet cleaning or by using vacuum cleaners with absolute filters;
 - (e) rapidly cleaning up spillages of asbestos-containing waters;
 - (f) frequent washing of all places where asbestos may have the potential to dry out;
4. treating waste gases from the cathode drying furnace with an absolute filter, if needed;
5. covering of prepared diaphragms during storage;

6. preventing the deterioration of the diaphragms during electrolysis by:
 - (a) using high-purity brine (Section 4.3.2.3.4);
 - (b) avoiding irregular operations, such as electrical load changes, changes in cell liquor concentration, brine concentration or pH, gas-pressure fluctuations, shutdowns, and uneven pH values in the various regions of the diaphragm;
7. removing spent asbestos from the cathode by hydroblasting in a separate room or in an enclosure with shielding and with smooth surfaces to prevent asbestos from adhering and drying;
8. regular monitoring at potential emission sources.

As an example, Figure 8.1 shows the handling of asbestos at the Dow plant in Stade (Germany). The entire process from the unloading of the bags to the preparation of the asbestos suspension is fully automated and sealed off hermetically [215, German Ministry 2011].

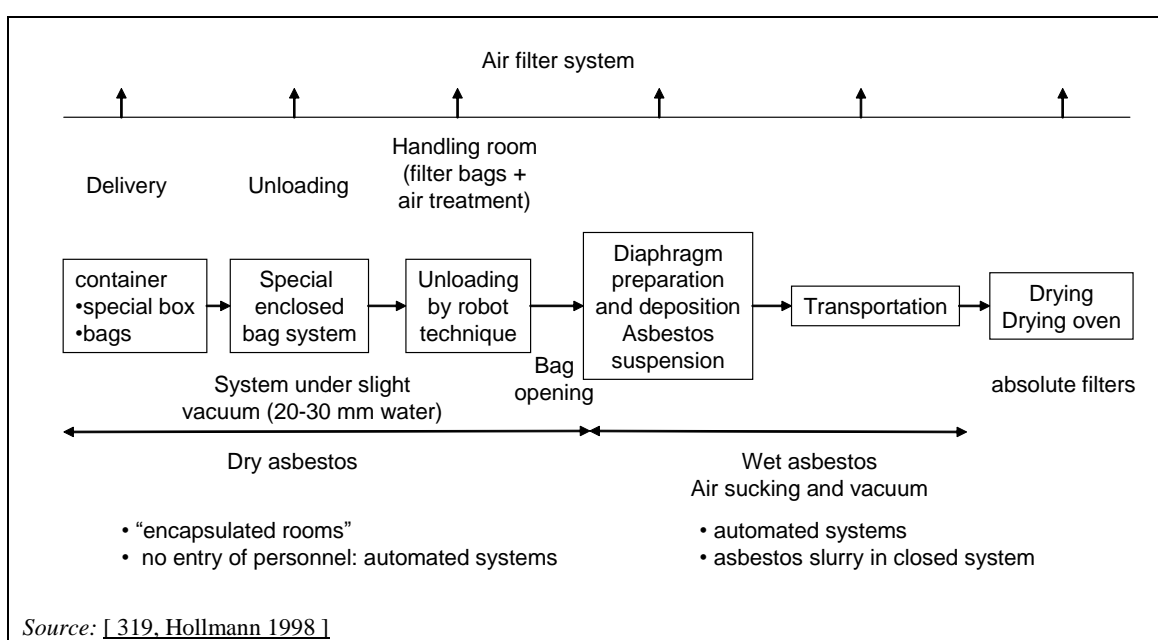

Figure 8.1: Example of handling of asbestos at the Dow plant in Stade (Germany)

Emissions to water

Emissions of asbestos to water can be reduced by sedimentation and filtration, for example by using a filter press [17, Dutch Ministry 1998].

Treatment of asbestos-containing wastes

Asbestos-containing wastes are thermally treated, chemically treated and/or landfilled, depending on the legislation of the country. A collection of potential treatment and disposal techniques can be found in [320, EHS 2004]. The reference document on Waste Treatments Industries (WT BREF) describes a thermochemical treatment technique that is applied at the Dow plant in Stade (Germany) [268, COM 2006]. During this process, the dangerous fibre structure is destroyed and converted to 'sand type' silicate structures through thermal treatment. In order to achieve this, all spent asbestos is dewatered in a centrifuge and chemicals are added to generate a mixture with a significantly reduced melting point. This mixture is then pelletised and the pellets are fed to a rotary kiln for the vitrification process, which takes place at 1 300 °C.

The resulting slag no longer contains asbestos fibres and can be used at landfill sites or to fill in underground cavities [215, German Ministry 2011].

Monitoring

Asbestos fibres are usually measured in air by fibre counting, using phase-contrast microscopy, according to the method recommended by the World Health Organization [321, WHO 1997].

For emissions of asbestos to water, the Directive 87/217/EEC provides in its Annex I a methodology for analysis and sampling based on gravimetry [79, Directive 87/217/EEC 1987].

Achieved environmental benefits

The achieved environmental benefits of this technique include:

- reduction of asbestos emissions to air and water;
- reduction of the generation of asbestos-containing waste.

Environmental performance and operational data

Two asbestos-diaphragm cell plants in Germany using an appropriate combination of the aforementioned techniques achieve a concentration of < 1000 fibres/m³ in workspace air (Table 3.40) [215, German Ministry 2011].

At the outlet of ventilation air from areas where asbestos is handled (storage and diaphragm preparation), two plants in Germany reported concentrations below the detection limit, in one case < 1 fibre/m³ and in the other < 100 fibres/m³ (Table 3.40) [303, GSA 2007], [304, GSA 2010], [305, ERGO 2008], [306, Müller-BBM 2011].

In a Dutch asbestos diaphragm cell plant using a filter press, the residual discharge of asbestos to water corresponded to approximately 0.1 g/t annual chlorine capacity (filter efficiency ~ 99 %) [17, Dutch Ministry 1998].

The consumption of asbestos and therefore the generation of asbestos-containing waste can generally be reduced to ≤ 0.1 kg/t annual chlorine capacity. Reported figures for asbestos waste from two plants in operation in 2012 amounted to 0.064 and 0.08 kg/t annual chlorine capacity (Section 3.6.5) [215, German Ministry 2011], [301, Zachem 2012].

Cross-media effects

Some raw materials and energy are consumed for the installation and operation of the facilities to handle asbestos. Techniques to reduce emissions of asbestos to air and water generate asbestos-containing waste that requires further treatment and/or disposal.

Technical considerations relevant to applicability

Generally, there are no technical restrictions to the applicability of these techniques.

Economics

Depending on the equipment installed, costs may vary a lot. The 'encapsulated' rooms for unloading and handling asbestos may be expensive, as automated systems are generally involved.

At the Dow plant in Stade (Germany), investment costs amounted to approximately DEM 18 million in 1991 to 1994 for an encapsulated and fully automated system (equivalent to EUR 9.3 million, currency conversion date May 1994, EUR/DEM = 1.933 64) [215, German Ministry 2011].

Example plants

- Dow in Stade (Germany), chlorine capacity of diaphragm cell unit 1 030 kt/yr;
- Solvay in Rheinberg (Germany), chlorine capacity of diaphragm cell unit 110 kt/yr; in 2012, the plant was converted to asbestos-free diaphragms;

- Zachem in Bydgoszcz (Poland), chlorine capacity 72 kt/yr, plant was shut down in 2012 [298, Euro Chlor 2013].

Driving force for implementation

The driving forces for implementation of this technique include:

- environmental legislation;
- occupational health and safety legislation.

Reference literature

[17, Dutch Ministry 1998], [45, Euro Chlor 1997], [79, Directive 87/217/EEC 1987], [124, EC 2003], [215, German Ministry 2011], [268, COM 2006], [298, Euro Chlor 2013], [301, Zachem 2012], [303, GSA 2007], [304, GSA 2010], [305, ERGO 2008], [306, Müller-BBM 2011], [319, Hollmann 1998], [320, EHS 2004], [321, WHO 1997]

GLOSSARY

This glossary is meant to facilitate the understanding of the information contained in this document. The definitions of terms in this glossary are not legal definitions (even if some of them may coincide with definitions given in European legislation), they are meant to help the reader understand some key terms in the context of their use in the specific sector covered by this document.

This glossary is divided up into the following sections:

- I. ISO country codes
- II. Monetary units
- III. Symbols commonly used in this document
- IV. Unit prefixes
- V. Units
- VI. Chemical elements
- VII. Chemical formulae commonly used in this document
- VIII. Acronyms and technical definitions

I. ISO country codes

ISO code	Country
<i>Member States (*)</i>	
BE	Belgium
BG	Bulgaria
CZ	Czech Republic
DE	Germany
IE	Ireland
EL	Greece
ES	Spain
FR	France
IT	Italy
LU	Luxembourg
HU	Hungary
NL	Netherlands
AT	Austria
PL	Poland
PT	Portugal
RO	Romania
SI	Slovenia
SK	Slovakia
FI	Finland
SE	Sweden
UK	United Kingdom
<i>Non-member countries</i>	
CH	Switzerland
NO	Norway
US	United States
(*) The protocol order of the Member States is based on the alphabetical order of their geographical names in the original language(s).	

II. Monetary units

Code ⁽¹⁾	Country/territory	Currency
<i>Member State currencies</i>		
EUR	Euro area ⁽²⁾	euro (pl. euros)
ATS	Austria	Austrian schilling
BEF	Belgium	Belgian franc
CZK	Czech Republic	Czech Koruna
DEM	Germany	German mark
GBP	United Kingdom	pound sterling
NLG	Netherlands	Dutch guilder
PLN	Poland	zloty (pl. zlotys)
<i>Other currencies</i>		
JPY	Japan	yen
NOK	Norway	Norwegian krone (pl. kroner)
USD	United States ⁽³⁾	US dollar
⁽¹⁾ ISO 4217 codes. ⁽²⁾ Includes Austria, Belgium, Cyprus, Estonia, Finland, France, Germany, Greece, Ireland, Italy, Luxembourg, Malta, the Netherlands, Portugal, Slovakia, Slovenia and Spain. Other territories officially, unilaterally or de facto using the euro are Andorra, Monaco, San Marino, Vatican City, Montenegro and Kosovo. ⁽³⁾ Also American Samoa, British Virgin Islands, East Timor, Ecuador, Guam, Marshall Islands, Micronesia, Northern Marianas, Palau, Puerto Rico, Turks and Caicos Islands, United States Minor Outlying Islands, and the US Virgin Islands.		

III. Symbols commonly used in this document

Symbol	Meaning
A	coefficient depending on the efficiency of the electricity conversion (from high voltage alternating to lower voltage direct current) and on the current efficiency in the electrolysis; the value of A ranges from 756 to 840 kWh/(V · t Cl ₂ produced), corresponding to overall electrolysis efficiencies of 90–100 %, the lower end of the percentage range corresponding to the higher end of the range of A and the higher end of the percentage range corresponding to the lower end of the range of A
C	chlorine capacity in kt/yr
j	electric current density expressed in A/m ²
K	complex factor expressed in V·m ² /kA depending on the geometry and the distance between electrodes, the nature of the separator between electrodes (necessary to avoid contact between the products), the temperature and concentration of the liquids, and the internal equipment pressure
P_{100}	investment costs in EUR/t annual chlorine capacity for a plant with a chlorine capacity of 100 kt/yr
P_C	investment costs in EUR/t annual chlorine capacity for a plant with a chlorine capacity of C
U_0	electric potential expressed in V; U_0 is composed of the difference in electrode potentials and the activation overpotentials at zero current
w	specific electricity consumption in kWh/t Cl ₂ produced

IV. Unit prefixes

Symbol	Prefix	Term	Number
T	tera	10^{12}	1 000 000 000 000
G	giga	10^9	1 000 000 000
M	mega	10^6	1 000 000
k	kilo	10^3	1 000
-----	-----	1 unit	1
c	centi	10^{-2}	0.01
m	milli	10^{-3}	0.001
μ	micro	10^{-6}	0.000 001
n	nano	10^{-9}	0.000 000 001

V. Units

Term	Meaning
A	amp(ere)
AC kWh	kilowatt-hours (alternating current)
bar	bar (1.013 bar = 100 kPa)
$^{\circ}$ C	degree Celsius
d	day
DC kWh	kilowatt-hours (direct current)
ECU	Electrochemical Unit. 1 ECU is equivalent to the co-production of 1.000 t chlorine, 1.128 t sodium hydroxide (100%) and 0.028 t hydrogen.
G	gram
h	hour
Hz	hertz ($1 \text{ Hz} = 1 \text{ s}^{-1}$)
J	joule
K	kelvin ($0^{\circ} \text{ C} = 273.15 \text{ K}$)
kWh	kilowatt-hour ($1 \text{ kWh} = 3\,600 \text{ kJ} = 3.6 \text{ MJ}$)
l	litre
m	metre
min	minute
Pa	Pascal ($1 \text{ Pa} = 1 \text{ N/m}^2$)
ppb	parts per billion ($1 \text{ ppb} = 10^{-9}$)
ppbv	parts per billion (by volume)
ppm	parts per million ($1 \text{ ppm} = 10^{-6}$)
ppmw	parts per million (by weight)
ppmv	parts per million (by volume)
s	second
t	metric tonne ($1\,000 \text{ kg}$ or 10^6 g)
V	volt
vol-%	percentage by volume
wt-%	percentage by weight
W	watt ($1 \text{ W} = 1 \text{ J/s}$)
yr	year

VI. Chemical elements

Symbol	Name	Symbol	Name
Al	Aluminium	Mg	Magnesium
Ba	Barium	Mo	Molybdenum
Br	Bromine	N	Nitrogen
C	Carbon	Na	Sodium
Ca	Calcium	Ni	Nickel
Cd	Cadmium	O	Oxygen
Cl	Chlorine	Pb	Lead
Co	Cobalt	Ru	Ruthenium
Cr	Chromium	S	Sulphur
Cu	Copper	Si	Silicon
F	Fluorine	Sn	Tin
Fe	Iron	Sr	Strontium
H	Hydrogen	Ti	Titanium
Hg	Mercury	V	Vanadium
I	Iodine	W	Tungsten
Ir	Iridium	Zn	Zinc
K	Potassium	Zr	Zirconium

VII. Chemical formulae commonly used in this document

Substance	
BaCO ₃	Barium carbonate
BaCl ₂	Barium chloride
BaSO ₄	Barium sulphate
Br ⁻	Bromide
Br ₂	Bromine
BrO ₃ ⁻	Bromate
CHCl ₃	Trichloromethane (Chloroform)
CH ₂ Cl ₂	Dichloromethane (Methylene chloride)
CCl ₄	Carbon tetrachloride
C ₂ Cl ₄	Tetrachloroethylene
CO ₂	Carbon dioxide
CaCl ₂	Calcium chloride
CaSO ₄	Calcium sulphate
Cl ⁻	Chloride
Cl ₂	Chlorine
ClO ₂ ⁻	Chlorite
ClO ₃ ⁻	Chlorate
e ⁻	Electron
FeCl ₃	Ferric chloride
H ₂	Hydrogen
HCl	Hydrochloric acid
HClO	Hypochloric acid
H ₂ O	Water
H ₂ O ₂	Hydrogen peroxide
H ₃ NSO ₃	Sulphamic acid
H ₂ SO ₄	Sulphuric acid
HgCl ₂	Mercury(II) chloride, mercuric chloride
Hg ₂ Cl ₂	Mercury(I) chloride, mercurous chloride, calomel
KCl	Potassium chloride
KOH	Potassium hydroxide, caustic potash
N ₂	Nitrogen
NCl ₃	Nitrogen trichloride
NH ₃	Ammonia
NaCl	Sodium chloride
Na ₂ CO ₃	Sodium carbonate
Na ₄ [Fe(CN) ₆]·10 H ₂ O	Sodium ferrocyanide decahydrate
NaHCO ₃	Sodium hydrogen carbonate
NaHSO ₃	Sodium hydrogen sulphite
Na-Hg _x	Sodium amalgam
NaOCl	Sodium hypochlorite
NaOH	Sodium hydroxide, caustic soda
NaS	Sodium sulphide
Na ₂ SO ₃	Sodium sulphite
Na ₂ SO ₄	Sodium sulphate
Na ₂ SO ₄ ·10 H ₂ O	Sodium sulphate decahydrate
Na ₂ S ₂ O ₃	Sodium thiosulphate
Na ₂ S ₄ O ₆	Sodium tetrathionate
O ₂	Oxygen
OBr ⁻	Hypobromite
OCl ⁻	Hypochlorite
SO ₂	Sulphur dioxide
SO ₄ ²⁻	Sulphate
SiO ₂	Silicon dioxide

VIII. Acronyms and definitions

Abbreviations/Acronyms	
AC	Alternating current.
Anode	Electrode through which electric current flows into a polarised electrical device. The polarity can be positive or negative. In electrolytic cells, oxidation occurs at the positively charged anode.
AOX	Adsorbable organically bound halogens.
Asbestos	Set of six naturally occurring silicate minerals exploited commercially for their desirable physical properties. Chrysotile (also called white asbestos) is the only form of asbestos used in diaphragm cell plants.
BAT	Best Available Technique. The most effective and advanced stage in the development of activities and their methods of operation which indicate the practical suitability of particular techniques for providing, in principle, the basis for emission limit values designed to prevent and, where that is not practicable, generally to reduce emissions and the impact on the environment as a whole (Industrial Emissions Directive).
BAT-AEL	BAT-associated emission level.
Bleach	Solution containing a substance that removes colours or whitens, often via oxidation. In this document, bleach refers to an aqueous solution of sodium hypochlorite.
BOD	Biochemical oxygen demand.
BREF	BAT reference document.
Brine	Solution saturated or nearly saturated with sodium chloride or potassium chloride.
By-product	A substance or object resulting from a production process, the primary aim of which is not the production of that item, which meets the following conditions: (a) further use of the substance or object is certain; (b) the substance or object can be used directly without any further processing other than normal industrial practice; (c) the substance or object is produced as an integral part of a production process; and (d) further use is lawful, i.e. the substance or object fulfils all relevant product, environmental and health protection requirements for the specific use and will not lead to overall adverse environmental or human health impacts (Directive 2008/98/EC on waste).
Cathode	Electrode through which electric current flows out of a polarised electrical device. The polarity can be positive or negative. In electrolytic cells, reduction occurs at the negatively charged cathode.
Caustic	Sodium hydroxide (NaOH) or potassium hydroxide (KOH).
Caustic potash	Potassium hydroxide (KOH).
Caustic soda	Sodium hydroxide (NaOH).
Caustic solution	Solution containing a strong base. In this document, caustic solution refers to solutions of sodium hydroxide or potassium hydroxide.
CEFIC	European Chemical Industry Council (from its French name Conseil Européen des Fédérations de l'Industrie Chimique). CEFIC is the main European association for the chemical industry.
CEN	European Committee for Standardisation (from its French name Comité Européen de Normalisation).
Chrysotile	White asbestos, the most commonly encountered form of asbestos. The chemical formula is $Mg_3Si_4O_{10}(OH)_2$.
CIS	Commonwealth of Independent States.
CN	Chlorinated naphthalene.
COD	Chemical oxygen demand.
Comproportionation	Redox reaction where two reactants, each containing the same element but with a different oxidation number, will form a product with an oxidation number intermediate of the two reactants.

Abbreviations/Acronyms	
Co-product	Any of two or more products coming from the same unit process or product system (ISO 14044: Environmental management – Life cycle assessment – Requirements and guidelines). In the chlor-alkali industry, chlorine, caustic and hydrogen are co-products of brine electrolysis.
DC	Direct current.
Difference to balance	Arithmetic difference between the mercury outputs and inputs of a mercury cell chlor-alkali plant. The outputs include mercury emissions to air, water and via products, as well as mercury disposed of with waste.
Diffuse emissions	Emissions which do not occur via specific emission points (stacks, etc.).
Disproportionation	Redox reaction in which a species is simultaneously reduced and oxidised so as to form two different products.
DPD	<i>N,N</i> -diethyl-1,4-phenylenediamine.
EDC	Ethylene dichloride.
EFTA	European Free Trade Association. Member countries from 1995 to 2014 have been Iceland, Liechtenstein, Norway, Switzerland.
Electrode	Electrical conductor used to make contact with a non-metallic part of an electric circuit.
Electrolyser	Apparatus in which electrolysis is carried out. An electrolyser consists of several electrolytic cells arranged in parallel or series.
Electrolysis	Passage of a direct electric current through an ionic substance, resulting in chemical reactions at the electrodes. The ionic substance is either molten or dissolved in a suitable solvent.
Emission	Direct or indirect release of substances, vibrations, heat or noise from individual or diffuse sources in the installation into air, water or land (Industrial Emissions Directive).
EMECAP	European Mercury Emissions from Chlor-Alkali Plants. A project funded by the European Union.
EMS	Environmental Management System.
EN	European Standard adopted by CEN.
EOX	Extractable organically bound halogens.
EU	European Union.
EU-15	Member States of the European Union before 1 May 2004.
EU-27	Member States of the European Union from 1 January 2007.
Euro Chlor	European association representing the chlor-alkali industry.
Exergy	In thermodynamics, the exergy of a system is the maximum useful work possible during a process that brings the system into equilibrium with a heat reservoir.
Free chlorine	Group of oxidising species present in waste water of chlor-alkali plants including dissolved elementary chlorine, hypochlorite, hypochlorous acid, dissolved elementary bromine, hypobromite, and hypobromic acid.
Fugitive emissions	Emissions which occur via leaks (e.g. due to untightened or corroded equipment). Fugitive emissions are a subset of diffuse emissions.
GWP	Global Warming Potential.
HCFC	Hydrochlorofluorocarbon.
Heavy metals	Metals with a density greater than 4.5 kg/l (1998 Aarhus Protocol on Heavy Metals to the 1979 Convention on Long-Range Transboundary Air Pollution).
HFC	Hydrofluorocarbon.
Installation	Stationary technical unit within which one or more activities listed in Annex I or in Part 1 of Annex VII of the Industrial Emissions Directive are carried out, and any other directly associated activities on the same site which have a technical connection with the activities listed in those Annexes and which could have an effect on emissions and pollution (Industrial Emissions Directive).
IPPC	Integrated Pollution Prevention and Control.
ISO	International Organisation for Standardisation or standard adopted by this organisation.

Abbreviations/Acronyms	
Joule heating	Process by which the passage of an electric current through a conductor releases heat. The process is also known as ohmic heating or resistive heating.
ODC	Oxygen-Depolarised Cathode.
ODP	Ozone Depletion Potential.
OSPAR	Convention for the protection of the marine environment of the North-East Atlantic. The Contracting Parties comprise the governments of Belgium, Denmark, Finland, France, Germany, Iceland, Ireland, Luxembourg, The Netherlands, Norway, Portugal, Spain, Sweden, Switzerland and United Kingdom, together with the European Union.
Overpotential	Voltage difference between a half-reaction's thermodynamically determined reduction potential and the potential at which the redox event is experimentally observed. In an electrolytic cell the overpotential leads to the consumption of more energy than thermodynamically expected to drive a reaction.
PAH	Polycyclic Aromatic Hydrocarbon.
PARCOM	Commission of the Paris Convention for the protection of the North-East-Atlantic from pollution derived from land-based sources. This convention and another one, the Oslo Convention, were unified, updated and extended in 1992, resulting in the OSPAR Convention for the protection of the marine environment of the North-East Atlantic.
PCB	Polychlorinated biphenyl.
PCDD	Polychlorinated dibenzo- <i>p</i> -dioxin.
PCDF	Polychlorinated dibenzofuran.
PCN	Polychlorinated naphthalene.
Plant	Installation.
PMA	Polymer Modified Asbestos.
Pollution	Direct or indirect introduction, as a result of human activity, of substances, vibrations, heat or noise into air, water or land which may be harmful to human health or the quality of the environment, result in damage to material property, or impair or interfere with amenities and other legitimate uses of the environment (Industrial Emissions Directive).
Potash	Salts that contain potassium in water-soluble form. In this document, potash refers to potassium chloride (KCl).
PTFE	Polytetrafluorethylene.
PVC	Polyvinyl chloride.
Site	Geographical location of an installation. A specific site may be used by other operators and/or installations.
Site remediation	Containment and/or decontamination of contaminated environmental media such as soil, groundwater, sediment or surface water from an industrial site. The area of the site may be larger than the fenced area.
Standard conditions	Reference point of a material used to calculate its properties. In this document, the standard conditions refer to a temperature of 273.15 K and a pressure of 1 bar.
Sylvinite	Mineral composed of a mechanical mixture of sylvite (KCl, or potassium chloride) and halite (NaCl, or sodium chloride).
Technique	Ensemble of both the technology used and the way in which an installation is designed, built, maintained, operated and decommissioned (Industrial Emissions Directive).
TEQ	Toxic Equivalent. The TEQ is a single figure resulting from the sum of the products of the concentrations of individual PCDDs, PCDFs and PCBs and their individual Toxic Equivalent factors.
TOC	Total Organic Carbon.
TWG	Technical Working Group.
UNEP	United Nations Environment Programme.
VCM	Vinylchloride monomer.

REFERENCES

- [1] Ullmann's, 'Chlorine', *Ullmann's Encyclopedia of Industrial Chemistry*, 7th edition, electronic release, 2006.
- [2] Le Chlore, *Le Chlore*, 5ème édition (Chlorine, 5th edition), 2002.
- [3] Euro Chlor, *Comments and information provided to working document three during the first review of the chlor-alkali BREF*, 2011.
- [4] WCC, *World chlorine production capacities (January 2012)*, 2012.
- [5] CMAI, *2011 World Chlor-Alkali Analysis*, Chemical Market Associates, Inc., 2010.
- [6] Euro Chlor, *Data on European Chlor-Alkali Industry*, 2011.
- [7] Euro Chlor, *The European Chlor-Alkali industry: an electricity intensive sector exposed to carbon leakage*, 2010.
- [8] Euro Chlor, *Chlorine Industry Review 2010-2011*, 2011.
- [9] Euro Chlor, *Chlorine Industry Review 2012-2013*, 2013.
- [10] Kirk-Othmer, 'Chlorine', *Kirk-Othmer Encyclopedia of Chemical Technology*, 2002.
- [11] UNEP, *Estimate of Global Mercury Cell Chlorine Capacity*, 2012.
- [12] Ullmann's, 'Potassium Compounds', *Ullmann's Encyclopedia of Industrial Chemistry*, 7th edition, electronic release, 2000.
- [13] Euro Chlor, *Questions and Answers on the Chlor-Alkali Sector and the EU Emission Trading Scheme (ETS)*, 2010.
- [14] Eurostat, *Statistics Database*, 2012.
- [15] AMAP/UNEP, *Technical Background Report to the Global Atmospheric Mercury Assessment*, 2013.
- [16] Agência Portuguesa do Ambiente, *Portuguese contribution to the review of the chlor-alkali BREF - Hydrogen production, storage and handling*, 2010.
- [17] Dutch Ministry, *Dutch Notes on BAT for the Chlor-Alkali Industry*, Ministry of Housing, Spatial Planning and the Environment, The Netherlands, 1998.
- [18] BASF, *Photo of a mercury cell room*, 2010.
- [19] Bommaraju et al., *Brine Electrolysis*, 2007.
- [20] Occidental Chemical Corporation, *Photo of a chlor-alkali cell room with MDC-55 diaphragm cells*, 2007.
- [21] Kirk-Othmer, 'Metal Anodes', *Kirk-Othmer Encyclopedia of Chemical Technology*, 1995.
- [22] Uhde, *Chlor-alkali electrolysis plants - Superior membrane process*, 2009.
- [23] BASF, *Information regarding membrane cells*, 2010.
- [24] Asahi Kasei, *Information regarding membrane cells*, 2008.
- [25] Vinnolit, *Photo of a bipolar membrane cell room in Gendorf/Germany*, 2011.
- [26] Euro Chlor, *The membrane cell process*, 2010.
- [27] ANE, *NaCl manufacturing from potash mining tailings*, 2010.
- [28] EIPPCB, *Compilation of liquid caustic specifications from various suppliers*, 2011.
- [29] Asahi Glass, *Photos and flow diagram of secondary brine purification for the membrane cell technique*, 1998.
- [30] Euro Chlor, *Use of hydrogen co-produced*, 2010.
- [31] Euro Chlor, *Application of non-asbestos diaphragm material*, 2010.

References

- [32] Solvay, *Photo of a monopolar membrane cell room in Tavaux/France*, 2010.
- [33] Euro Chlor, *Chlor-alkali BREF update - Liquid effluents recycling*, 2011.
- [34] Solvay, *Information provided during site visits to Solvin chlor-alkali sites in Lillo/Antwerp and Jemeppe (Belgium) on 15-16 December 2010*, 2010.
- [35] Euro Chlor, *Maximum Levels of Nitrogen Trichloride in Liquid Chlorine*, 2012.
- [36] Euro Chlor, *Chlor-alkali BREF update - Use of carbon tetrachloride*, 2010.
- [37] Euro Chlor, *Chlor-alkali BREF update - 'Once-through' brine plants*, 2010.
- [38] O'Brien and White, 'Process Engineering Aspects of Chlorine Cooling and Drying', *Modern Chlor-Alkali Technology*, Vol. 6, 1995, pp. 70-81.
- [39] HMSO, *Chief Inspector's Guidance to Inspectors - Processes for the Manufacture of, or Which Use or Release Halogens, Mixed Halogen Compounds or Oxohalocompounds*, Her Majesty's Inspectorate of Pollution, 1993.
- [40] Euro Chlor, *Pressure Storage of Liquid Chlorine*, 2002.
- [41] Euro Chlor, *Low Pressure Storage of Liquid Chlorine*, 2002.
- [42] Euro Chlor, *Euro Chlor position paper on KCl electrolysis*, 2010.
- [43] Spolchemie, *Czech contribution to the first review of the chlor-alkali BREF - Potash resources, potassium rock salts and typical composition of potassium chloride*, 2010.
- [44] OxyChem, *Caustic Soda Handbook*, 1992.
- [45] Euro Chlor, *Recommendations for a Best Available Techniques Reference Support Document - Chlorine Production by the Electrolysis of Brine*, 1997.
- [46] Ullmann's, 'Sodium Hydroxide', *Ullmann's Encyclopedia of Industrial Chemistry, 7th edition, electronic release*, 2006.
- [47] De Dietrich, *Sulfuric acid concentration*, 2011.
- [48] ICIS Chemical Business, 'Chlor-alkali market stable', *ICIS Chemical Business*, Vol. 3-9 January, 2011, p. 22.
- [49] Euro Chlor, *Chlor-alkali BREF update - New and emerging technologies*, 2010.
- [50] Asahi Glass, *Recent Progress of Flemion Membrane*, 1999.
- [51] Bulan, 'CO₂ Reduction during the Production of Basic Chemicals', *klimazwei - Research for Climate Protection and Protection from Climate Impacts*, 2007, Berlin.
- [52] Moussallem et al., 'Chlor-alkali electrolysis with oxygen depolarized cathodes: history, present status and future prospects', *Journal of Applied Electrochemistry*, Vol. 38, No 9, 2008, pp. 1177-1194.
- [53] Bulan et al., 'CO₂-Reduktion bei der Herstellung chemischer Grundstoffe – Einsatz von Sauerstoffverzehrkatoden bei der Chlorherstellung (CO₂ reduction during the production of basic chemicals - Use of oxygen-depolarised cathodes for the production of chlorine)', *Klimaschutz und Anpassung an die Klimafolgen - Strategien, Maßnahmen und Anwendungsbeispiele*, 2009, pp. 61-68.
- [54] Euro Chlor, *Chlor-alkali BREF update - Chlorine drying*, 2010.
- [55] Euro Chlor, *Mercury emissions per site (2005-2013)*, 2014.
- [56] Euro Chlor, *The Chlorine Reference Manual*, 2008.
- [57] CAK TWG, *Analysis of questionnaires provided by chlor-alkali plants in the EU-27 and EFTA countries in 2010 and 2012 during the first review of the BREF*, 2012.
- [58] Euro Chlor, *Energy consumption data of chlor-alkali plants in the EU-27 and EFTA countries*, 2010.
- [59] Euro Chlor, *Chlor-alkali BREF update - Treatment of solid mercury containing materials*, 2010.
- [60] SRI Consulting, *Chemical Economics Handbook - Chlorine/Sodium Hydroxide*, SRI Consulting, 2008.

- [61] DG CLIMA, *Report of undertakings on consumption and emissions of controlled substances as process agents under regulation EC/1005/2009*, 2012.
- [62] UNECE, *Guidelines for the control of emissions from the inorganic chemical industry*, 1985.
- [63] Euro Chlor, *Euro Chlor position on energy consumption in chlor-alkali production*, 2011.
- [64] IEA, *Energy Technology Transitions for Industry - Strategies for the Next Industrial Revolution*, 2009.
- [65] Millet, 'Cellules d'électrolyse chlore-soude (Chlor-alkali electrolysis cells)', *Techniques de l'Ingénieur*, 2008.
- [66] Ullmann's, 'Sodium chloride', *Ullmann's Encyclopedia of Industrial Chemistry, 7th edition, electronic release*, 2010.
- [67] Euro Chlor, *Determination of chlorine in workplace air*, 2010.
- [68] AkzoNobel, *Memorandum: Verzoek wijziging vergunning ivm onvoorziene emissie chloordioxide MEB Delfzijl (Note on the request for modification of the integrated environmental permit of the chlor-alkali plant in Delfzijl due to unforeseen emissions of chlorine dioxide)*, 2007.
- [69] Regierungspräsidium Dessau, *Permit for the chlor-alkali plant in Bitterfeld*, 1999.
- [70] COM, *Reference Document on the General Principles of Monitoring (MON REF)*, 2003.
- [71] UK Environment Agency, *UK contribution to the review of the chlor-alkali BREF - Solution mined brine use and treatment*, 2009.
- [72] Nishio, 'Effect of brine impurities on cell voltage', *8th International Chlorine Technology Conference and Exhibition*, 2011, Budapest (Hungary).
- [73] Debelle, 'Euro Chlor 10 years sustainability programme results', *8th International Chlorine Technology Conference and Exhibition*, 2011, Budapest (Hungary).
- [74] Directive 2008/105/EC, 'Directive 2008/105/EC of the European Parliament and of the Council of 16 December 2008 on environmental quality standards in the field of water policy, amending and subsequently repealing Council Directives 82/176/EEC, 83/513/EEC, 84/156/EEC, 84/491/EEC, 86/280/EEC and amending Directive 2000/60/EC of the European Parliament and of the Council', *Official Journal of the European Union*, Vol. L 348, 24.12.2008, 2008, pp. 84-97.
- [75] COM, *BREF on Chlor-Alkali Manufacturing Industry (CAK)*, 2001.
- [76] Regulation EC/1272/2008, 'Regulation (EC) No 1272/2008 of the European Parliament and of the Council of 16 December 2008 on classification, labelling and packaging of substances and mixtures, amending and repealing Directives 67/548/EEC and 1999/45/EC, and amending Regulation (EC) No 1907/2006', *Official Journal of the European Union*, Vol. L 353, 31.12.2008, 2008, pp. 1-1355.
- [77] Directive 2010/75/EU, 'Directive 2010/75/EU of the European Parliament and of the Council of 24 November 2010 on industrial emissions (integrated pollution prevention and control)', *Official Journal of the European Union*, Vol. L 334, 17.12.2010, 2010, pp. 17-119.
- [78] Regulation EC/1005/2009, 'Regulation EC/1005/2009 of the European Parliament and of the Council of 16 September 2009 on substances that deplete the ozone layer', *Official Journal of the European Union*, Vol. L 286, 31.10.2009, 2009, pp. 1-30.
- [79] Directive 87/217/EEC, 'Directive 87/217/EEC of the Council of 19 March 1987 on the prevention and reduction of environmental pollution by asbestos', *Official Journal of the European Communities*, Vol. L 85, 28.03.1987, 1987, pp. 40-45.
- [80] Engel, 'Managing safety issues in the chlor-alkali industry', *8th International Chlorine Technology Conference and Exhibition*, 2011, Budapest (Hungary).
- [81] eMARS, *Electronic Major Accident Reporting System*, 2011.
- [82] Euro Chlor, *Annual report to the European Commission on mercury stored in mercury cell chlor-alkali plants in the EU-27 countries on 31 December 2012*, 2013.
- [83] Euro Chlor, *Mercury electrolysis technology - Hg emissions reported to production capacity*, 2010.

References

- [84] Euro Chlor, *Mercury emissions from Western European chlor-alkali plants for the period 1977-1998 as reported to OSPAR*, 2000.
- [85] Euro Chlor, *Mercury emissions from Western European chlor-alkali plants for the year 2009 as reported to OSPAR*, 2011.
- [86] Euro Chlor, *Guidelines for making a mercury balance in a chlorine plant*, 2010.
- [87] Euro Chlor, *Guideline for the minimisation of mercury emissions and wastes from mercury chlor-alkali plants*, 2006.
- [88] Directive 2009/161/EU, 'Commission Directive 2009/161/EU of 17 December 2009 establishing a third list of indicative occupational exposure limit values in implementation of Council Directive 98/24/EC and amending Commission Directive 2000/39/EC', *Official Journal of the European Union*, Vol. L 338, 19.12.2009, 2009, pp. 87-89.
- [89] Euro Chlor, *Code of Practice - Mercury housekeeping*, 2004.
- [90] PARCOM Decision 90/3, *PARCOM Decision 90/3 of 14 June 1990 on reducing atmospheric emissions from existing chlor-alkali plants*, 1990.
- [91] Euro Chlor, *Mercury electrolysis technology - Waste water treatment*, 2011.
- [92] Gluszczyk et al., *Biological mercury removal (BIOMER) as best available technology for treatment of mercury contaminated wastewater*, 2007.
- [93] Euro Chlor, *Potassium hydroxide and potassium carbonate applications in Europe in 2009*, 2011.
- [94] Euro Chlor, *Guideline for decommissioning of mercury chlor-alkali plants*, 2009.
- [95] EEB, *The European chlor-alkali industry - Is national implementation of the IPPC Directive contributing to a mercury-free industry? - Results of an environmental NGO study*, 2008.
- [96] Euro Chlor, *Mercury electrolysis technology - Difference to balance*, 2010.
- [97] Concorde, *Status report: Mercury cell chlor-alkali plants in Europe*, 2006.
- [98] Southworth et al., 'Fugitive mercury emissions from a chlor-alkali factory: sources and fluxes to the atmosphere', *Atmospheric Environment*, Vol. 38, 2004, pp. 597-611.
- [99] Kinsey et al., 'Characterization of fugitive mercury emissions from the cell building of a US chlor-alkali plant', *Atmospheric Environment*, Vol. 38, 2004, pp. 623-631.
- [100] Grönlund et al., 'Elemental mercury emissions from chlor-alkali plants measured by LIDAR techniques', *Atmospheric Environment*, Vol. 39, 2005, pp. 7474-7480.
- [101] US EPA, 'National emission standards for hazardous air pollutants: Mercury emissions from mercury cell chlor-alkali plants - Proposed rule', *Federal Register*, Vol. 73, No 113, 2008, pp. 33258-33282.
- [102] EMECAP, *European Mercury Emissions from Chlor-Alkali Plants (EMECAP) - Final project report*, 2004.
- [103] US EPA, 'National emission standards for hazardous air pollutants: Mercury emissions from mercury cell chlor-alkali plants - Proposed rule', *Federal Register*, Vol. 76, No 49, 2011, pp. 13852-13878.
- [104] US EPA, *Summary of 2005 cell room mercury emissions data for Occidental chemical company mercury cell chlor-alkali plants: Delaware City, Delaware and Muscle Shoals, Alabama*, 2008.
- [105] US EPA, *Summary of cell room mercury emissions data for Olin mercury cell chlor-alkali plant: Charleston, Tennessee*, 2007.
- [106] Landis et al., 'Divalent inorganic reactive gaseous mercury emissions from a mercury cell chlor-alkali plant and its impact on near-field atmospheric dry deposition', *Atmospheric Environment*, Vol. 38, 2004, pp. 613-622.
- [107] Euro Chlor, *Chlorine Industry Review 2004-2005*, 2006.
- [108] UNEP, *Minamata Convention on Mercury*, 2013.
- [109] European Commission, *BREF on Industrial Cooling Systems (ICS)*, European Commission, 2001.

- [110] Euro Chlor, *Chlor-alkali BREF update - Use of waste water streams containing free chlorine in other production units*, 2013.
- [111] Dow, *Information provided during the site visit to the Dow chlor-alkali plant in Stade (Germany) on 29 November 2012*, 2012.
- [112] Euro Chlor, *Answer to a request for additional information concerning energy consumption*, 2012.
- [113] Moussallem et al., 'Möglichkeiten zur Energierückgewinnung bei der Chlor-Alkali-Elektrolyse (Possibilities of energy recovery for chlor-alkali electrolysis)', *Chemie Ingenieur Technik*, Vol. 81, No 4, 2009, pp. 489-493.
- [114] Delfrate and Schmitt, 'Integration of fuel cells systems into chlor alkali plants: The chlorine industry perspective', *18th World Hydrogen Energy Conference*, 2010, Essen (Germany).
- [115] Jörissen et al., 'Chlorherstellung mit Sauerstoffverzehrkathoden (Chlorine production with oxygen-depolarised cathodes)', *Chemie in unserer Zeit*, Vol. 45, 2011, pp. 172-183.
- [116] Euro Chlor, *Chlor-alkali BREF update - Techniques to reduce mercury emissions and to reduce the generation of waste contaminated with mercury*, 2013.
- [117] Euro Chlor and Spolchemie, *Answer to a request for additional information concerning chlorine and hydrogen cooling*, 2012.
- [118] Solvay, *Information provided during the site visit to the Solvay chlor-alkali plant in Rheinberg (Germany) on 30 June 2011*, 2011.
- [119] Euro Chlor, *The European chlor-alkali industry - On the move towards sustainable development*, 2002.
- [120] Euro Chlor, *Euro Chlor's contribution to the European Commission's consultation document on the development of an EU Mercury Strategy*, 2005.
- [121] MicroBio, *Information for the review of the chlor-alkali BREF*, 2012.
- [122] Bayer, *Oxygen-depolarised cathodes*, 2012.
- [123] Gaucher and Dolladille, 'Conventions on multi-operator sites: an efficient risk management tool', *4th Global Congress on Process Safety*, 2008, New Orleans (US).
- [124] EC, *BREF on Common Waste Water and Waste Gas Treatment/Management Systems in the Chemical Sector (CWW)*, 2003.
- [125] Aker Chemetics, *Sulphate removal system - Preliminary assessment information*, 2010.
- [126] Lashkari and Drackett, 'Applications of membrane technologies in the chloralkali industry', *8th International Chlorine Technology Conference and Exhibition*, 2011, Budapest (Hungary).
- [127] Eckert, 'Additional information on sulphate removal by nanofiltration', Personal Communication, 2010.
- [128] SABIC, *Brine recovery in the production of polycarbonate*, 2008.
- [129] Euro Chlor, *Chlorine Industry Review 2006-2007*, 2007.
- [130] Austria, 'Verordnung des Bundesministers für Land- und Forstwirtschaft über die Begrenzung von Abwasseremissionen aus der Chlor-Alkali-Elektrolyse (AEV Chlor-Alkali-Elektrolyse) (Ordinance of the Federal Minister for agriculture and forestry on the limitation of waste water emissions from chlor-alkali electrolysis (AEV chlor-alkali electrolysis))', *Bundesgesetzblatt der Republik Österreich*, Vol. 672, 1996.
- [131] Germany, 'Hinweise und Erläuterungen zum Anhang 42 - Alkalichloridelektrolyse - der Verordnung über Anforderungen an das Einleiten von Abwasser in Gewässer (Notes and explanations to the Annex 42 - Chlor-alkali electrolysis - of the Ordinance on Requirements for the Discharge of Waste Water into Waters)', *Bundesanzeiger*, Vol. 75a, 2003, p. 17.
- [132] Germany, 'Hinweise und Erläuterungen zum Anhang 22 - Chemische Industrie - der Verordnung über Anforderungen an das Einleiten von Abwasser in Gewässer (Notes and explanations to the annex 22 -

- chemical industry - of the Ordinance on Requirements for the Discharge of Waste Water into Waters)', *Bundesanzeiger*, 2000.
- [133] Chlorine Engineers, *Commitment to electro-chemicals - Corporate brochure*, 2011.
- [134] INEOS, *Chlor-alkali electrolyser technology*, 2011.
- [135] Asahi Kasei, 'New zero-gap electrolysis system from AKCC', *8th International Chlorine Technology Conference and Exhibition*, 2011, Budapest (Hungary).
- [136] Asahi Kasei, *Acilyzer - Membrane chlor-alkali electrolyzers*, 2008.
- [137] Euro Chlor, *Chlor-alkali BREF update - Production costs*, 2010.
- [138] Prochemics, *Impact of Electricity Price on the Competitiveness of the European Chlor-Alkali Industry*, 2007.
- [139] Europe's Energy Portal, *Electricity prices - Industrial consumption*, 2011.
- [140] Giatti, 'mTA-salt - Safe savings', *8th International Chlorine Technology Conference and Exhibition*, 2011, Budapest (Hungary).
- [141] AkzoNobel, *mTA-salt - Safe savings - The future of chlorine electrolysis*, 2011.
- [142] AkzoNobel, *New generation anti caking agent for salt - Application for CEFIC European Responsible Care Award 2010*, 2010.
- [143] Healy, 'Technical considerations of membrane cell room design', *8th International Chlorine Technology Conference and Exhibition*, 2011, Budapest (Hungary).
- [144] Alfa Laval, *NaOH concentration with plate evaporators*, 2011.
- [145] Decision 2000/532/EC, 'Commission Decision 2000/532/EC of 3 May 2000 replacing Decision 94/3/EC establishing a list of wastes pursuant to Article 1(a) of Council Directive 75/442/EEC on waste and Council Decision 94/904/EC establishing a list of hazardous waste pursuant to Article 1(4) of Council Directive 91/689/EEC on hazardous waste', *Official Journal of the European Communities*, Vol. L 226, 6.9.2000, 2000, pp. 3-22.
- [146] Arkema, *Information provided during site visits to Arkema chlor-alkali sites in Lavéra, Fos-sur-mer and Sausset-les-Pins (France) on 1-3 December 2009*, 2009.
- [147] Arkema, *Photo of a chlorine absorption unit*, 2011.
- [148] Directive 2002/49/EC, 'Directive 2002/49/EC of the European Parliament and of the Council of 25 June 2002 relating to the assessment and management of environmental noise', *Official Journal of the European Communities*, Vol. L 187, 18.7.2002, 2002, pp. 12-25.
- [149] Directive 2003/10/EC, 'Directive 2003/10/EC of the European Parliament and of the Council of 6 February 2003 on the minimum health and safety requirements regarding the exposure of workers to the risks arising from physical agents (noise)', *Official Journal of the European Union*, Vol. L 42, 15.2.2003, 2003, pp. 38-44.
- [150] ISO, *ISO 5667-3: Water quality - Sampling - Part 3: Guidance on the preservation and handling of water samples*, 2003.
- [151] VITO, *LUC/III/002 method: Bepaling van lage gehaltenes gasvormig chloor in een gaskanaal (Determination of low levels of gaseous chlorine in a gas duct)*, 2010.
- [152] Linde, *R600a refrigerant grade isobutane - High quality natural refrigerant*, 2010.
- [153] Spolchemie, *Answer to a request for additional information concerning refrigerants used for chlorine liquefaction*, 2012.
- [154] Dräger, *Dräger-Röhrchen - Das Labor hinter Glas (Dräger tubes - The laboratory behind glass)*, 2009.
- [155] WRUSS, *AOX/EOX im Abwasser der Elektrolyse (AOX/EOX in waste water from electrolysis)*, 2012.

- [156] CEN, *EN ISO 10304-4: Water quality - Determination of dissolved anions by liquid chromatography of ions - Part 4: Determination of chlorate, chloride and chlorite in water with low contamination*, 1999.
- [157] CEN, *EN ISO 9562: Water quality - Determination of adsorbable organically bound halogens (AOX)*, 2004.
- [158] DIN, *DIN 38409 - H 8: Bestimmung der extrahierbaren organisch gebundenen Halogene (EOX) (DIN 38409 - H 8: Determination of extractable organically bound halogens (EOX))*, 1984.
- [159] ASI, *OENORM M 6614: Wasseruntersuchung - Bestimmung der extrahierbaren organisch gebundenen Halogene (EOX) (OENORM M 6614: Water analysis - Determination of extractable organically bound halogens (EOX))*, 2001.
- [160] Szolderits, 'Information provided for the first review of the chlor-alkali BREF', Personal Communication, 2012.
- [161] Germany, 'Verordnung über Anforderungen an das Einleiten von Abwasser in Gewässer (Abwasserverordnung - AbwV) (Ordinance on Requirements for the Discharge of Waste Water into Waters (AbwV))', *Bundesgesetzblatt I*, 2004, p. 1108, 2625.
- [162] CEN, *EN ISO 7393-1: Water quality - Determination of free chlorine and total chlorine - Part 1: Titrimetric method using N,N-diethyl-1,4-phenylenediamine*, 2000.
- [163] CEN, *EN ISO 7393-2: Water quality - Determination of free chlorine and total chlorine - Part 2: Colorimetric method using N,N-diethyl-1,4-phenylenediamine for routine control purposes*, 2000.
- [164] CEN, *EN ISO 7393-3: Water quality - Determination of free chlorine and total chlorine - Part 3: Iodometric titration method for the determination of total chlorine*, 2000.
- [165] EA UK, *Chemical disinfecting agents in waters and effluents*, 2008.
- [166] CEN, *EN 13211: Air quality - Stationary source emissions - Manual method of determination of the concentration of total mercury*, 2001.
- [167] CEN, *EN 14884:2005 Air quality - Stationary source emissions - Determination of total mercury: automated measuring systems*, 2005.
- [168] ISO, *ISO 17733: Workplace air - Determination of mercury and inorganic mercury compounds - Method by cold-vapour atomic absorption spectrometry or atomic fluorescence spectrometry*, 2004.
- [169] Ijspeerd et al., 'Biamperometric determination of free chlorine, hypochlorite, chlorite and chlorate in sodium chloride brine', *Fresenius Zeitschrift für Analytische Chemie*, Vol. 288, 1977, pp. 357-360.
- [170] Desai et al., 'Chromatographic determination of anions in industrial salt and sodium chloride brines used in chlor-alkali industry', *Journal of Chromatography A*, Vol. 841, No 1, 1999, pp. 55-62.
- [171] Metrohm, *Determination of chlorate and sulfate in a brine solution (1.5% NaCl) using anion chromatography with conductivity detection after chemical suppression*, 2011.
- [172] CEN, *EN ISO 10304-1: Water quality - Determination of dissolved anions by liquid chromatography of ions - Part 1: Determination of bromide, chloride, fluoride, nitrate, nitrite, phosphate and sulfate*, 2009.
- [173] CEN, *EN ISO 15682: Water quality - Determination of chloride by flow analysis (CFA and FIA) and photometric or potentiometric detection*, 2001.
- [174] ISO, *ISO 9297: Water quality - Determination of chloride - Silver nitrate titration with chromate indicator (Mohr's method)*, 1989.
- [175] CEN, *EN ISO 12846: Water quality - Determination of mercury - Method using atomic absorption spectrometry (AAS) with and without enrichment*, 2012.
- [176] ISO, *ISO 22743: Water quality - Determination of sulfates - Method by continuous flow analysis (CFA)*, 2006.
- [177] CEN, *EN 13657: Characterization of waste - Digestion for subsequent determination of aqua regia soluble portion of elements*, 2002.

References

- [178] CEN, *EN 13656: Characterization of waste - Microwave assisted digestion with hydrofluoric (HF), nitric (HNO₃) and hydrochloric (HCl) acid mixture for subsequent determination of elements*, 2002.
- [179] VDI, *VDI 3488-1: Messen gasförmiger Emissionen - Messen der Chlorkonzentration - Methylorange-Verfahren (Gaseous emission measurement - Measurement of chlorine and oxides of chlorine - Methyl orange method)*, 1979.
- [180] VDI, *VDI 3488-2: Messen gasförmiger Emissionen - Messen der Chlorkonzentration - Bromid-Jodid-Verfahren (Gaseous emission measurement - Measurement of chlorine concentration - Bromide iodide method)*, 1980.
- [181] USDOL-OSHA, *Sampling and analytical methods - Chlorine in workplace atmospheres*, 1991.
- [182] USDOL-OSHA, *Sampling and analytical methods - Chlorine and chlorine dioxide in workplace atmospheres*, 2011.
- [183] USDOL-OSHA, *Sampling and analytical methods - Determination of chlorine dioxide in workplace atmospheres*, 1991.
- [184] Euro Chlor, *Determination of mercury in gases*, 2008.
- [185] InfoMil, *Technique to consider in the determination of BAT: Addition of hydrogen peroxide to prevent emissions of chlorine dioxide*, NL Agency - Dutch Ministry of Infrastructure and the environment, 2011.
- [186] Euro Chlor, *Site hydrogen used in 2010*, 2011.
- [187] Debelle and Millet, 'Information on ferrocyanide destruction', Personal Communication, 2011.
- [188] DuPont, *General information on Nafion membrane for electrolysis*, 2006.
- [189] Nitini, 'Additional information on Nafion membranes', Personal Communication, 2011.
- [190] Czarnetzki and Janssen, 'Formation of hypochlorite, chlorate and oxygen during NaCl electrolysis from alkaline solutions at an RuO₂/TiO₂ anode', *Journal of Applied Electrochemistry*, Vol. 22, 1992, pp. 315-324.
- [191] Lassche, 'Information on chlorine dioxide formation in the chlorine absorption unit', Personal Communication, 2011.
- [192] Euro Chlor, *Equipment for the treatment of gaseous effluents containing chlorine*, 2011.
- [193] Jia et al., 'General-acid-catalyzed reactions of hypochlorous acid and acetyl hypochlorite with chlorite ion', *Inorganic Chemistry*, Vol. 39, No 12, 2000, p. 2614–2620.
- [194] Gordon and Tachiyashiki, 'Kinetics and mechanism of formation of chlorate ion from the hypochlorous acid/chlorite ion reaction at pH 6-10', *Environmental Science and Technology*, Vol. 25, No 3, 1991, p. 468–474.
- [195] Bolyard et al., 'Occurrence of chlorate in hypochlorite solutions used for drinking water disinfection', *Environmental Science and Technology*, Vol. 26, No 8, 1992, p. 1663–1665.
- [196] Euro Chlor, *Answer to a request for additional information concerning the mercury cell technique*, 2012.
- [197] Götaverken Miljö, *Soil remediation in Bohus, Sweden*, 2000.
- [198] WMO, *Scientific Assessment of Ozone Depletion: 2006*, 2006.
- [199] Bezirksregierung Lüneburg, *Permit for the chlor-alkali plant in Stade*, 1997.
- [200] UBA DE, *Avoiding fluorinated greenhouse gases - Prospects for phasing out*, 2011.
- [201] Piersma, 'Nitrogen trichloride (NCl₃): a continuing challenge', *Euro Chlor fifth technical seminar - A sustainable future for chlorine - Improving health, safety and environmental performance*, 2001, Barcelona (Spain).
- [202] AkzoNobel, 'Information on carbon tetrachloride-free techniques to control nitrogen trichloride impurities at the AkzoNobel plants in Delfzijl and Rotterdam-Botlek (Netherlands)', Personal Communication, 2010.

- [203] Eckerscham, 'Additional information on Flemion membranes', Personal Communication, 2011.
- [204] Asahi Glass, *Development of Flemion membranes*, 2011.
- [205] Ullmann's, 'Sodium sulfates', *Ullmann's Encyclopedia of Industrial Chemistry, 7th edition, electronic release*, 2000.
- [206] Denye et al., 'The Hydecate process - Fit and forget technology for hypochlorite destruction', *Modern Chlor-Alkali Technology*, Vol. 6, UK, 1995, pp. 251-257.
- [207] Stitt et al., 'New process options for hypochlorite destruction', *Modern Chlor-Alkali Technology*, Vol. 8, 2001, pp. 315-332.
- [208] Johnson Matthey, *Environmental catalysts - Hydecate*, 2009.
- [209] COM, *Reference Document on Best Available Techniques for the Manufacture of Large Volume Inorganic Chemicals - Solids and Others industry*, 2007.
- [210] Beekman, 'Hypochlorite recycling to diaphragm cells', *Modern Chlor-Alkali Technology*, Vol. 8, 2001, pp. 173-181.
- [211] Dibble and White, 'Practical experience in mercury and diaphragm cell conversions to membrane technology', *Modern Chlor-Alkali Technology*, Vol. 4, 1988, pp. 291-305.
- [212] Florkiewicz, *Long life diaphragm cell*, 1997.
- [213] Florkiewicz and Curlin, 'Polyramix(TM) diaphragm - A commercial reality', *Modern Chlor-Alkali Technology*, Vol. 5, 1992, p. 209.
- [214] Dilmore and DuBois, 'PPG's Tephram(TM) synthetic diaphragm circuit conversion', *Modern Chlor-Alkali Technology*, Vol. 6, 1995, pp. 133-139.
- [215] German Ministry, *Report on the derogation for diaphragms containing chrysotile pursuant to point 6 of Annex XVII to the REACH regulation*, 2011.
- [216] O'Brien et al., *Handbook of Chlor-Alkali Technology*, Springer, 2005.
- [217] PPG, *PPG technology improves performance in diaphragm cell chlor-alkali production*, 2010.
- [218] Ahmed and Foller, 'Responding to a harsh business environment: A new diaphragm for the chlor-alkali industry', *The Electrochemical Society Interface*, Vol. 12, No 4, 2003, pp. 34-39.
- [219] Carbocloro, *Relatorio de sustentabilidade - Ano base 2008 (Sustainability report - Base Year 2008)*, 2008.
- [220] Polish Ministry, *Report to the European Commission on the availability of asbestos-free substitutes for electrolysis installations and the efforts undertaken to develop such alternatives, on the protection of the health of workers in the installations, on the source and quantities of chrysotile, on the source and quantities of diaphragms containing chrysotile, and the envisaged date of the end of the exemption*, 2011.
- [221] Florkiewicz, 'Information on diaphragm technology', Personal Communication, 1998.
- [222] Euro Chlor, *Guidelines for the preparation for permanent storage of metallic mercury above ground or in underground mines*, 2007.
- [223] ICIS Chemical Business, 'Chemical profile - Caustic soda', *ICIS Chemical Business*, Vol. 5-18 April 2010, 2010, p. 36.
- [224] Bayer, 'Information provided during the site visit to the Bayer chlor-alkali plant in Uerdingen (Germany) in 1998', Personal Communication, 1998.
- [225] Lott, 'Practical experiences on the conversion of mercury cells to membrane technology', *Modern Chlor-Alkali Technology*, Vol. 6, 1995, pp. 243-250.
- [226] Schindler, 'Information provided for the elaboration of the original chlor-alkali BREF', Personal Communication, 2000.
- [227] de Flon, 'Information provided during the site visit to the Borregaard chlor-alkali plant in Sarpsborg (Norway) in 1998', Personal Communication, 1998.

- [228] PPG, *Membrane technology eliminates use of mercury at Lake Charles - PPG dedicates USD 100 million membrane cell production unit in Louisiana*, 2007.
- [229] Oceana, *Cleaning up: Taking mercury-free chlorine production to the bank*, 2007.
- [230] Schubert, 'Information provided for the elaboration of the original chlor-alkali BREF', Personal Communication, 2000.
- [231] Chemie Produktion, 'Eingriff am Offenen Herzen (Open Heart Surgery)', *Chemie Produktion*, 2000, pp. 120-121.
- [232] Euro Chlor, *Chlor-alkali BREF update: Break-down of conversion costs from mercury to membrane technology*, 2010.
- [233] AkzoNobel, *AkzoNobel setzt einzigartiges Eindampfsystem für Natronlauge ein (AkzoNobel employs unique caustic evaporation system)*, 2012.
- [234] UBA AT, *BAT Reference Document Chlor-Alkali: Austrian Statement*, 1998.
- [235] ANE, *Spanish chlor-alkali plants conversion cost summary*, 2010.
- [236] EIPPCB, 'Confidential information provided from chlor-alkali manufacturers regarding the marketability of caustic potash produced with the membrane cell technique', Personal Communication, 2011.
- [237] Lindley, *An economic and environmental analysis of the chlor-alkali production process - Mercury cells and alternative technologies*, ICI Chemical & Polymers, 1997.
- [238] Clews, 'Replacement of mercury chlor-alkali plants with new membrane plants in Australia', *Modern Chlor-Alkali Technology*, Vol. 8, 2001, pp. 128-139.
- [239] COM, *State aid: Commission endorses EUR 18.5 million of aid to reduce mercury emissions in Italy*, 2005.
- [240] Otto et al., 'Case study on remediation of a German city contaminated by a chloroalkali plant and PCP production', *Organohalogen Compounds*, Vol. 68, 2006, pp. 880-885.
- [241] COWI, *Options for reducing mercury use in products and applications, and the fate of mercury already circulating in society (Report prepared for Directorate General Environment of the European Commission, Contract: ENV.G.2/ETU/2007/0021)*, COWI - Concorde, 2008.
- [242] Lutz et al., 'Neue Altlast - Hochgrading mit polychlorierten Dibenzofuranen belastete Rückstände aus der Chlorerzeugung gelangten jahrzehntelang in die Umwelt (New contaminated site - Residues from chlorine production that were highly contaminated with polychlorinated dibenzofurans were discharged to the environment during decades)', *Müllmagazin*, Vol. 4, No 3, 1991, pp. 55-60.
- [243] Stenhammar, 'Information provided for the elaboration of the original chlor-alkali BREF', Personal Communication, 2000.
- [244] Hinton and Veiga, 'Mercury contaminated sites: A review of remedial solutions', *National Institute for Minamata Disease Forum*, 2001, Minamata (Japan).
- [245] Euro Chlor, *Management of Mercury Contaminated Sites*, 2012.
- [246] Wanga et al., 'Sources and remediation for mercury contamination in aquatic systems - a literature review', *Environmental Pollution*, Vol. 131, 2004, pp. 323-336.
- [247] Orica, *Orica mercury remediation project*, 2011.
- [248] Biester et al., 'Estimating distribution and retention of mercury in three different soils contaminated by emissions from chlor-alkali plants: part I', *The Science of the Total Environment*, Vol. 284, 2002, pp. 177-189.
- [249] Biester et al., 'Binding and mobility of mercury in soils contaminated by emissions from chlor-alkali plants', *The Science of the Total Environment*, Vol. 284, 2002, pp. 191-203.
- [250] Maserti and Ferrara, 'Mercury in plants, soil and atmosphere near a chlor-alkali complex', *Water, Air, and Soil Pollution*, Vol. 56, 1991, pp. 15-20.

- [251] Lodenius and Tulisalo, 'Environmental mercury contamination around a chlor-alkali plant', *Bulletin of Environmental Contamination and Toxicology*, Vol. 32, 1984, pp. 439-444.
- [252] Chang and Hen, 'On-site mercury-contaminated soils remediation by using thermal desorption technology', *Journal of Hazardous Materials*, Vol. B128, 2006, pp. 208-217.
- [253] Nording et al., 'Rapid screening of dioxin-contaminated soil by accelerated solvent extraction/purification followed by immunochemical detection', *Analytical and Bioanalytical Chemistry*, Vol. 385, 2006, pp. 357-366.
- [254] van Bavel et al., 'Pressurised hot water/steam extraction of polychlorinated dibenzofurans and naphthalenes from industrial soil', *The Analyst*, Vol. 124, 1999, pp. 1351-1354.
- [255] Kannan et al., 'Congener profile of polychlorinated/brominated dibenzo-p-dioxins and dibenzofurans in soil and sediments collected at a former chlor-alkali plant', *Toxicological and Environmental Chemistry*, Vol. 67, 1998, pp. 135-146.
- [256] Kannan et al., 'Distribution and characterization of polychlorinated biphenyl congeners in soil and sediments from a superfund site contaminated with aroclor 1268', *Environmental Science and Technology*, Vol. 31, No 5, 1997, pp. 1483-1488.
- [257] Kannan et al., 'Isomer-specific analysis and toxic evaluation of polychlorinated naphthalenes in soil, sediment and biota collected near the site of a former chlor-alkali plant', *Environmental Science and Technology*, Vol. 32, 1998, pp. 2507-2514.
- [258] Johnson Matthey, *List of example plants using catalytic fixed-bed decomposition of hypochlorite*, 2011.
- [259] Rappe et al., 'Levels, profile and pattern of PCDDs and PCDFs in samples related to the production and use of chlorine', *Chemosphere*, Vol. 23, No 11-12, 1991, pp. 1629-1636.
- [260] Brack et al., 'Polychlorinated naphthalenes in sediments from the industrial region of Bitterfeld', *Environmental Pollution*, Vol. 121, No 1, 2003, pp. 81-85.
- [261] Järnberg et al., 'Distribution of polychlorinated naphthalene congeners in environmental and source-related samples', *Archives of Environmental Contamination and Toxicology*, Vol. 32, No 3, 1997, pp. 232-245.
- [262] Ilyushchenko et al., 'Monitoring the effectiveness of measures to contain the primary sources of mercury pollution on the site of a former chloralkali plant in Kazakhstan', *Sixth International Conference on Remediation of Chlorinated and Recalcitrant Compounds*, Battelle, Columbus, OH, 2008, Monterey/California (US).
- [263] Khrapunov et al., 'Development of integrated demercurization technology and facilities for its implementation in Kazakhstan', *Environmental Mercury Pollution: Mercury Emissions, Remediation and Health Effects*, 2007, Astana (Kazakhstan).
- [264] British Columbia Ministry, *Nexen: Former chlor-alkali plant, Squamish, BC*, 2009.
- [265] Hissler and Probst, 'Chlor-alkali industrial contamination and riverine transport of mercury: Distribution and partitioning of mercury between water, suspended matter, and bottom sediment of the Thur River, France', *Applied Geochemistry*, Vol. 21, 2006, pp. 1837-1854.
- [266] US EPA, *Treatment technologies for mercury in soil, waste and water*, 2007.
- [267] COM, *BREF on Waste Incineration (WI)*, 2006.
- [268] COM, *BREF on Waste Treatments Industries (WT)*, 2006.
- [269] Waste Framework Directive 98/EC, 'Directive 2008/98/EC of the European Parliament and of the Council of 19 November 2008 on waste and repealing certain Directives', *Official Journal of the European Union*, Vol. L 312, 22.11.2008, 2008, pp. 3-30.
- [270] Orica, *Chlorine liquefaction process*, 2011.
- [271] CEN, *EN ISO 17852: Water quality - Determination of mercury - Method using atomic fluorescence spectrometry*, 2006.

References

- [272] DIN, *DIN 38404 - C 6: Bestimmung der Redox-Spannung (Determination of the reduction potential)*, 1984.
- [273] ASI, *OENORM M 6618: Water analysis - Determination of the oxidation reduction (redox) potential*, 2005.
- [274] Ancery, 'Decommissioning of mercury electrolysis units', *8th International Chlorine Technology Conference and Exhibition*, 2011, Budapest (Hungary).
- [275] ANE, *Decommissioning experiences in Spanish chlor-alkali plants*, 2010.
- [276] French Ministry, *Lessons learnt from the mercury cells dismantling and decommissioning from an occupational health and safety perspective - Saint Auban (Arkema - France)*, 2010.
- [277] Dring, *Demolition and decommissioning of mercury cellrooms at ICI sites in the United Kingdom*, ICI Chlor-Chemicals, 2010.
- [278] Verberne and Maxson, *Mercury concerns in decommissioning chlor-alkali facilities in Western Europe*, Environmental Resources Management and Concorde East/West, 2000.
- [279] Regulation EC/1102/2008, 'Regulation (EC) 1102/2008 of the European Parliament and of the Council of 22 October 2008 on the banning of exports of metallic mercury and certain mercury compounds and mixtures and the safe storage of metallic mercury', *Official Journal of the European Union*, Vol. L 304, 14.11.2008, 2008, pp. 75-79.
- [280] Seveso II Directive (96/82/EC), 'Council Directive 96/82/EC of 9 December 1996 on the control of major accident hazards involving dangerous substances (Seveso II Directive)', *Official Journal of the European Communities*, Vol. L 010, 14.01.1997, 1996, pp. 13-33.
- [281] Directive 1999/31/EC, 'Council Directive 1999/31/EC of 26 April 1999 on the landfill of waste', *Official Journal of the European Communities*, Vol. L 182, 16.07.1999, 1999, pp. 1-19.
- [282] Directive 2011/97/EU, 'Council Directive 2011/97/EU of 5 December 2011 amending Directive 1999/31/EC as regards specific criteria for the storage of metallic mercury considered as waste', *Official Journal of the European Union*, Vol. L 328, 10.12.2011, 2011, pp. 49-52.
- [283] BiPRO, *Requirements for facilities and acceptance criteria for the disposal of metallic mercury*, 2010.
- [284] Krehenwinkel, 'Export ban and safe storage of surplus mercury', *8th International Chlorine Technology Conference and Exhibition*, 2011, Budapest (Hungary).
- [285] CEN, *EN ISO 15061: Water quality - Determination of dissolved bromate - Method by liquid chromatography of ions*, 2001.
- [286] COM, *Communication from the Commission to the Council and the European Parliament - Community Strategy Concerning Mercury*, 2005.
- [287] REACH Regulation (EC) No 1907/, 'Regulation (EC) No 1907/2006 of the European Parliament and of the Council of 18 December 2006 concerning the Registration, Evaluation, Authorisation and Restriction of Chemicals (REACH)', *Official Journal of the European Union*, Vol. L 396, 30.12.2006, 2006, pp. 1-849.
- [288] Evonik, *Potassium hydroxide solution 45 % and 50 % - Pure grade KOH in H₂O*, 2011.
- [289] OxyChem, *Sales specification - 45 % and 50 % Caustic potash membrane*, 2008.
- [290] Taixing Xiangyun Chemical, *High quality potassium hydroxide (ion membrane potassium hydroxide)*, 2011.
- [291] Kanto Chemical, *Alkali Reagent - High purity potassium hydroxide, granular (for precision analysis, UGR)*, 2011.
- [292] K+S Kali GmbH, *Technical data sheet: Potassium chloride approx. 99 % KCl, technical industrial, Version 3.1*, 2012.
- [293] Euro Chlor, *Answer to a request for additional information concerning various topics*, 2012.

- [294] Decision 2010/372/EU, 'Commission Decision of 18 June 2010 on the use of controlled substances as process agents under Article 8(4) of Regulation (EC) No 1005/2009 of the European Parliament and of the Council', *Official Journal of the European Union*, Vol. L 169, 3.7.2010, 2010, pp. 17-18.
- [295] Regulation EC/842/2006, 'Regulation EC/842/2006 of the European Parliament and of the Council of 17 May 2006 on certain fluorinated greenhouse gases', *Official Journal of the European Union*, Vol. L 161, 14.6.2006, 2006, pp. 1-11.
- [296] Euro Chlor, *Answer to a request for additional information concerning refrigerants used for chlorine liquefaction*, 2012.
- [297] Inspector's report, *Rapport de l'inspecteur des installations classées - Rejets de l'établissement Arkema à Lavéra (Report of the inspector for classified installations - Discharges from the Arkema plant in Lavéra)*, 2005.
- [298] Euro Chlor, *Comments and information provided to the revised draft after the final meeting during the first review of the chlor-alkali BREF*, 2013.
- [299] INEOS Runcorn, *Answer to a request for additional information concerning the airflow direction through mercury cell rooms*, 2012.
- [300] Euro Chlor, *Answer to a request for clarification concerning the Euro Chlor position on energy consumption in chlor-alkali production*, 2011.
- [301] Zachem, *Comments and information provided to draft 1 during the first review of the chlor-alkali BREF*, 2012.
- [302] Directive 2009/148/EC, 'Directive 2009/148/EC of the European Parliament and of the Council of 30 November 2009 on the protection of workers from the risks related to exposure to asbestos at work', *Official Journal of the European Union*, Vol. L 330, 16.12.2009, 2009, pp. 28-36.
- [303] GSA, *Bericht - Emissionsmessungen - Abluftkamin - Erweiterung 'Zellenfabrikationsgebäude' (Report - Emission measurements - Waste gas stack - Extension 'cell assembly building')*, 2007.
- [304] GSA, *Bericht - Emissionsmessungen - Abluftkamin - Erweiterung 'Zellenfabrikationsgebäude' (Report - Emission measurements - Waste gas stack - Extension 'cell assembly building')*, 2010.
- [305] ERGO, *Bericht über die Durchführung von Emissionsmessungen an der Quelle 94 der Asbestaufbereitungsanlage (Zellenwerkstatt) der Solvay Chemicals GmbH, Rheinberg, März 2008 (Report on emission measurements at source 94 of the asbestos-preparation facility (cell workshop) of Solvay Chemicals, Rheinberg, March 2008)*, 2008.
- [306] Müller-BBM, *Solvay Chemicals GmbH - Bericht über die Durchführung von Emissionsmessungen - EQ 94 (Asbestaufbereitungsanlage) (Solvay Chemicals - Report on emission measurements - EQ 94 (asbestos-preparation facility))*, 2011.
- [307] Hydro Polymers, *2007 EMAS - Eco-management and audit scheme - Environmental report*, 2007.
- [308] UNEP, *Draft paper on conversion from mercury to alternative technology in the chlor-alkali industry*, 2012.
- [309] Toxics Links, *Economics of conversion - Chlor-alkali plants in India*, 2012.
- [310] Basel Convention, *Technical guidelines for the environmentally sound management of wastes consisting of elemental mercury and wastes containing or contaminated with mercury*, 2011.
- [311] UNEP, 'Decision IG.20/8.1 - Regional Plan on the reduction of inputs of Mercury in the framework of the implementation of Article 15 of the LBS Protocol', *17th Meeting of the Contracting Parties to the Barcelona Convention*, 2012, Paris, 10-12 February 2012.
- [312] Euro Chlor and Spolchemie, *Answer to a request for additional information concerning the use of hydrogen*, 2012.
- [313] Euro Chlor and Dow, *Answer to a request for additional information concerning the diaphragm cell technique*, 2012.

References

- [314] Klima:aktiv, *Best practice: Donau Chemie AG - Thema: Aufbereitung und thermische Verwertung von Abfallgas aus Salzsäure-Syntheseanlagen (Best practice: Donau Chemie AG - Subject: Treatment and thermal recovery of waste gas from hydrochloric acid synthesis units)*, 2008.
- [315] Euro Chlor, *CAK BREF update - Answer to some questions of the draft chapters*, 2011.
- [316] Euro Chlor, *Comments provided to draft one during the first review of the chlor-alkali BREF*, 2012.
- [317] Euro Chlor and ANE, *Answer to a request for additional information concerning brine acidification*, 2012.
- [318] Dow, *Answer to a request for additional information concerning the availability of asbestos-free diaphragms*, 2012.
- [319] Hollmann, 'Fax from G. Hollmann dated 22 October 1998', Personal Communication, 1998.
- [320] EHS, *Best Practicable Environmental Option (BPEO) for the management of waste asbestos*, 2004.
- [321] WHO, *Determination of airborne fibre concentrations - A recommended method by phase-contrast optical microscopy (membrane filter method)*, 1997.
- [322] UNEP, *Report of the fifty-fifth meeting of the Executive Committee of the Multilateral Fund for the implementation of the Montreal Protocol, Bangkok, 14-18 July 2008*, 2008.
- [323] EC, *BREF on Emissions from Storage (EFS)*, 2006.
- [324] Euro Chlor, *Hazard analysis for chlorine plants*, 2003.
- [325] InfoMil, *Example permit conditions in the Netherlands regarding gas detection system*, 2012.
- [326] Euro Chlor, *Materials of construction for use in contact with chlorine*, 2009.
- [327] Euro Chlor, *Design principles and operational procedures for loading/off-loading liquid chlorine road and rail tankers and ISO-containers*, 2012.
- [328] HSE, *Safety advice for bulk chlorine installations, 2nd edition*, Crown, 2009.
- [329] Euro Chlor, *Examples of possible layouts of the chlorine absorption unit*, 2012.
- [331] Euro Chlor, *Guidelines for the interim storage of metallic mercury in shut down chlor-alkali plants*, 2011.
- [332] EIPPCB, *Figures prepared for the first review of the chlor-alkali BREF*, 2012.
- [333] Euro Chlor, *Comments and information provided to working document seven during the first review of the chlor-alkali BREF*, 2012.
- [334] Derwent et al., 'Global environmental impacts of the hydrogen economy', *International Journal of Nuclear Hydrogen Production and Application*, Vol. 1, No 1, 2006, pp. 57-67.
- [335] IPCC, *IPCC Fourth Assessment Report: Climate Change 2007 - Working Group I: The Physical Science Basis*, 2007.
- [336] Euro Chlor, *Euro Chlor contribution on economics for chlorine emissions to air*, 2012.
- [337] US EPA, *Method 26 - Determination of hydrogen halide and halogen emissions from stationary sources - Non isokinetic method*, 1988.
- [338] Directive 2012/18/EU, 'Directive 2012/18/EU of the European Parliament and of the Council of 4 July 2012 on the control of major-accident hazards involving dangerous substances, amending and subsequently repealing Council Directive 96/82/EC', *Official Journal of the European Union*, Vol. L 197, 24.7.2012, 2012, pp. 1-37.
- [339] CEN, *EN ISO 11885: Water quality — Determination of selected elements by inductively coupled plasma optical emission spectrometry (ICP-OES)*, 2007.
- [340] CEN, *EN ISO 17294-2: Water quality — Application of inductively coupled plasma mass spectrometry (ICP-MS) — Part 2: Determination of 62 elements*, 2003.
- [341] COM, *Proposal for a regulation of the European Parliament and of the Council on fluorinated greenhouse gases*, 2012.

-
- [342] Solvay, *Information on Funda(R) filters*, 1998.
- [343] UBA DE, *BAT Background document 'Chlorine production by chlor-alkali processes'*, 1997.
- [344] Uhdenora, *Uhdenora receives first order for new energy-efficient electrolysis technology*, 2014.
- [345] Platts, *Europe to remain net importer of caustic soda on capacity crunch*, 2014.
- [346] Euro Chlor, *Trend of the mercury emissions 1995–2013*, 2014.
- [347] AkzoNobel, *AkzoNobel opens new highly energy efficient membrane electrolysis plant in the industrial heart of Germany*, 2014.
- [348] INEOS ChlorVinyls, *INEOS ChlorVinyls announces outcome of internal asset review*, 2013.

Europe Direct is a service to help you find answers to your questions about the European Union
Freephone number (*): 00 800 6 7 8 9 10 11

(*): Certain mobile telephone operators do not allow access to 00 800 numbers or these calls may be billed.

A great deal of additional information on the European Union is available on the Internet.
It can be accessed through the Europa server <http://europa.eu>.

How to obtain EU publications

Our publications are available from EU Bookshop (<http://bookshop.europa.eu>),
where you can place an order with the sales agent of your choice.

The Publications Office has a worldwide network of sales agents.
You can obtain their contact details by sending a fax to (352) 29 29-42758.

European Commission

EUR 26844 EN – Joint Research Centre – Institute for Prospective Technological Studies

Title: Best Available Techniques (BAT) Reference Document for the Production of Chlor-alkali

Authors: Thomas Brinkmann, Germán Giner Santonja, Frauke Schorcht, Serge Roudier, Luis Delgado Sancho

Luxembourg: Publications Office of the European Union

2014 – 340 pp. – 21.0 x 29.7 cm

EUR – Scientific and Technical Research series – ISSN 1831-9424 (online)

ISBN 978-92-79-40945-5 (PDF)

doi:10.2791/13138

JRC Mission

As the Commission's in-house science service, the Joint Research Centre's mission is to provide EU policies with independent, evidence-based scientific and technical support throughout the whole policy cycle.

Working in close cooperation with policy Directorates-General, the JRC addresses key societal challenges while stimulating innovation through developing new methods, tools and standards, and sharing its know-how with the Member States, the scientific community and international partners.

Serving society
Stimulating innovation
Supporting legislation

